

# VIKETORY

Freedom is Victory

## USER MANUAL

### Granit



# Bicycle parts

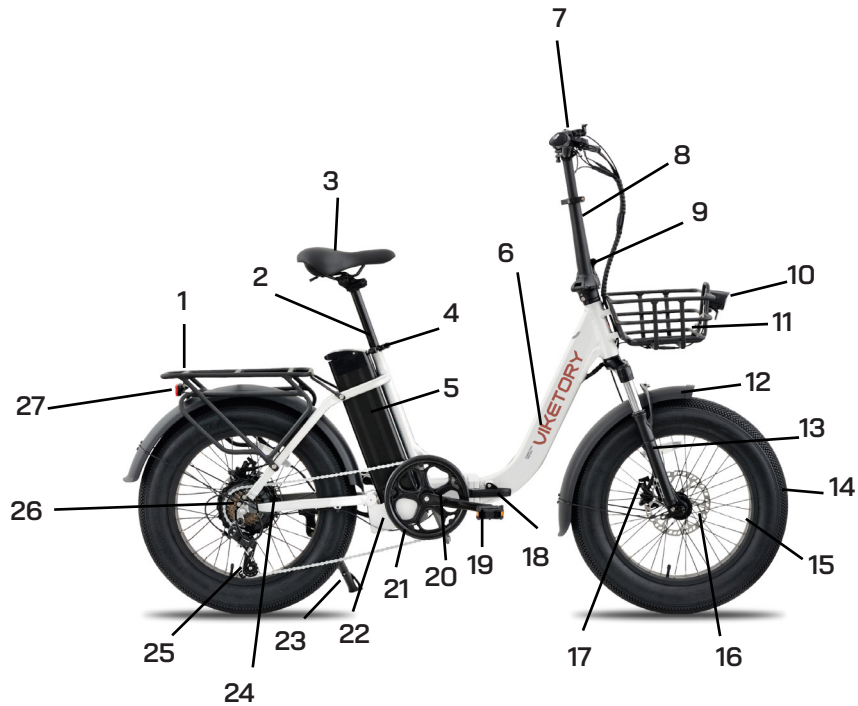

- |    |   |    |                       |
|----|---|----|-----------------------|
| 1  | Rear luggage rack                             | 16 | Brake disc            |
| 2  | Seat post                                     | 17 | Hydraulic brake       |
| 3  | Saddle  | 18 | Folding frame closure |
| 4  | Quick release                                 | 19 | Pedal                 |
| 5  | Integrated controller                         | 20 | Connecting rod        |
| 6  | Folding joint                                 | 21 | Chain ring            |
| 7  | Handlebar/Grip/Gear shift/Display/Brake lever | 22 | Controller            |
| 8  | Pole  | 23 | Stand                 |
| 9  | Folding frame closure                         | 24 | Rear engine           |
| 10 | Front headlight                               | 25 | Rear derailleur       |
| 11 | Front basket                                  | 26 | Cassette              |
| 12 | Front mudguard                                | 27 | Rear light            |
| 13 | Fork  |    |                       |
| 14 | Tire  |    |                       |
| 15 | Rim   |    |                       |

## Before starting...

The following instruction manual is a guide to assist you. This manual is not a comprehensive document covering all aspects of the maintenance and repair of your bicycle. The electric bicycle you have purchased is not a complex object; however, it is recommended that you consult an electric bicycle repair specialist if you have any doubts about your ability to ride, repair, or maintain this product.

It is important that you understand how the electric bicycle works. Reading this manual thoroughly before using it for the first time will help you get the best performance and enjoyment from this product; it is also useful for extending the life of the electric bicycle.

This operating manual must remain an integral part of the product. It is strictly prohibited to make changes or copies of the images, specifications, and descriptions.

## Index

1. Introduction	Pag. 4
2. Getting started	Pag. 6
3. Using your electric bicycle	Pag. 10
4. Using the display	Pag. 12
5. Maintenance and charging instructions	Pag. 14
6. Faults and troubleshooting	Pag. 15
7. Regular inspection checklist	Pag. 16
8. Legal requirements	Pag. 18

This manual describes the assembly and safe operation of your new electric bicycle. The images are for reference only and may show similar components from another model.

- Read the entire user manual before using your new electric bicycle.
- Always check the condition of the bicycle, brakes, tyres and the tightness of screws and nuts before use.
- Recharge your electric bicycle before your first use and after any long journey.

## **What you should know before your first use**

Read this manual carefully before using your electric bicycle to familiarise yourself with the bicycle and its various functions.

Follow all traffic regulations in your country when using your electric bicycle on public roads, including always wearing a helmet.

The right helmet should be comfortable for the cyclist and lightweight, as well as having good ventilation, fitting well and covering the front of the head.

It is your responsibility to know the laws of the country you are riding in and to comply with the laws regarding bicycles and electric bicycles.

Young children, pregnant women, and anyone with vision, balance, or other problems that prevent them from riding a bicycle should refrain from using an electric pedal bicycle.

This bicycle is not designed for two people; ensure that only one person rides the electric bicycle.

## **Safety warnings**

Electric bicycles are designed exclusively for use on roads or prepared trails and should not be used on rough trails. Off-road use may cause damage to the bicycle.

NEVER carry a passenger on the electric bicycle.

NEVER modify the electric bicycle with unapproved accessories.

NEVER ride in deep water.

NEVER perform stunts, jumps or wheelies.

AVOID riding in the rain for long periods of time.

AVOID water coming into contact with the motor or electrical wiring.

ALWAYS keep both hands on the handlebars.

ALWAYS apply light pressure to the brakes when riding on rocks or slippery surfaces.

ALWAYS be careful when riding through puddles.

ALWAYS inspect your electric bike before each ride to ensure a safe journey.

## **Attention:**

1. To save energy and extend battery life, please use the pedals to assist the electric bike when going uphill or in windy conditions.
2. Read the manual carefully and do not use the electric bike before familiarising yourself with how it works. Do not lend it to people who are unfamiliar with how it works.
3. In bad weather, such as rain or snow, the braking distance will increase. When the electric bicycle is travelling at 20 km/h, the braking distance in wet conditions should not exceed 15 metres. Please adjust the brakes frequently and replace the brake pads in good time.
4. For your safety and that of others, switch off the power supply when not in use.
5. Check the air pressure in the tyres. If the pressure is low, resistance will be greater, affecting the range.
6. The electrical components can only be cleaned on the outside; no internal maintenance is required. Do not open it yourself. (If these parts are opened by the user, the warranty will be void.)
7. Overloading the electric bicycle is prohibited. Overloading will damage the electrical components. (Plastic parts may become deformed due to high temperatures, or the fuse may be damaged by high temperatures.) Such damage is not covered by the warranty.
8. Switch off the device if there is a problem with the electrical parts.
9. Pay attention to the laws of your country when driving on public roads, for example regarding lighting and reflectors.
10. The noise emission level at the driver's ears should be less than 70 dB(A).
11. Regularly check your brakes, tyres, handlebars and rims to ensure a safe journey.
12. The handlebars can affect the vehicle's response when turning and braking.
13. We recommend purchasing suitable spare parts, such as tyres, inner tubes and brake components.
14. Do not use a trailer with your bicycle.
15. Warning: Do not touch hot surfaces after prolonged use. (e.g. brake disc)

## Getting started

First, carefully unpack your electric bicycle and keep all packaging materials. Ensure you locate your charger, pedals, and all small parts, such as nuts and bolts. Sometimes small parts, such as nuts and bolts, can become loose during shipping, so be sure to carefully check the bottom of the box and protective packaging. Keep the packaging until you have assembled the bike and know that it is working properly.

## Assembly instructions

This bicycle was fully assembled, inspected and adjusted at the factory, and then partially disassembled for shipping.

Your bicycle arrives in the packaging 95% assembled. To ship the bicycle, the pedals, saddle, front wheel and, sometimes, the handlebars may be loosened or removed. To ensure the safety and performance of the bicycle, the requirements for tightening the screws in key locations must be followed.

Names of screws	Standard tightening torque / N.m
Handlebar screw	8-10 Nm
Stem screw	10-12 Nm
Clamping screw	5-6 Nm
Saddle	18-20 Nm
Seat post	15-20 Nm
Front wheel	12-25 Nm
Rear wheel	40-45 Nm
Luggage rack	6-8 Nm
Pedal	35 Nm
Rack	6-8 Nm

This manual will list all the steps required for various models.

Follow the basic assembly instructions that will guide you in getting your bicycle ready for use. If you have any doubts about your ability to assemble this product, consult a qualified bicycle technician.

***We recommend that the electric bicycle be assembled by two people working together.***

## Secure and adjust the handlebars

Your handlebar has two main parts: the bar itself and the adjustable grip. If your bar has been removed for shipping, place it in the centre of the handlebar or check that the grips are in the correct position and that the angle of the bar is comfortable. Tighten the clamping screws to secure the bar in place, ensuring that all brake cables are loose.

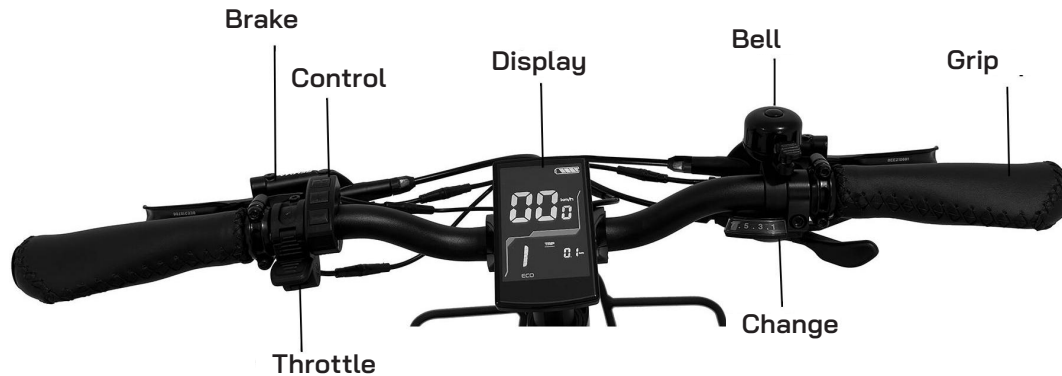
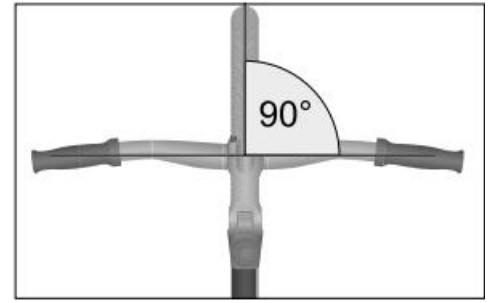

Ensure that the fork and handlebars are facing forwards and straight. Stand in front of the handlebars, hold the front wheel and handlebars, and adjust the handlebars and bike frame to form a 90-degree angle, as shown in the image.

Some models have a light/power meter console that attaches to the handlebars. Secure it with the plastic brackets and screws provided.

## Check and adjust the brake disc.

The rear brake is controlled with the right brake lever, the front brake is controlled with the left brake lever.

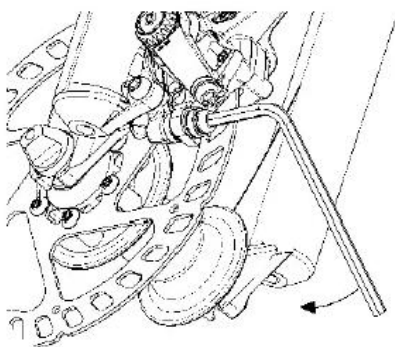

Always check that both brakes are adjusted before riding your bicycle.

Squeeze the brake and slide the cable through the groove. You may need to adjust the length of the cable by loosening the nut and sliding the cable to the correct position. Tighten the nut again to maintain the correct position. Hydraulic disc brakes do not require adjustment of the brake cable housing length.

Adjust the brake pads on both sides using an Allen key so that they make contact with the metal rim and not the tyre. Ensure that they are straight and that the distance between the rim and the two brake pads is 1-1.5 mm. The brake pads will close when they are correctly adjusted.

There are small adjustment screws on the sides of the brake pad levers that can be used to adjust the distance on each side. If the distance between the two brake pads and the rim is different, adjust the spring adjustment screw on the two brake arms of the fixed bracket until the distance between the two sides is the same, ensuring that you can brake effectively. If the brake pad is badly damaged, replace it in good time to ensure the effectiveness of the brake.

## Saddle adjustment

The saddle height is adjusted using a quick-release system. Pull the quick-release lever, insert the seat post to at least the minimum insertion line marked on the seat post. Tighten the adjustment nut with the quick-release lever, then push the quick-release lever to the closed position.

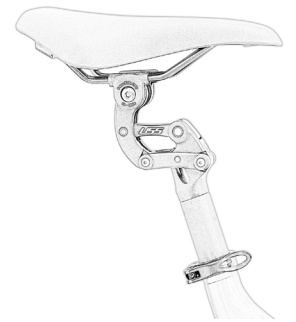

The angle of the saddle can be adjusted using the nuts that secure the seat to the seat rail. Ensure that the nuts are tightened securely and that the seat does not move forwards or backwards while you are sitting on it.

When you sit on the saddle and press the pedal with your heel, when the pedal is in the lowest position, your legs should be slightly stretched. At this point, the height is correct. If the cyclist can only press the pedal with their toes or their legs cannot be stretched slightly, fatigue and sports injuries will occur, so it is necessary to carefully adjust the height of the saddle.

## Assemble the pedals

The pedals are marked with 'L' and 'R' on the end of the axle. Screw the pedal marked "L" onto the left side and the one marked 'R' onto the right side.

(1). The right pedal is attached to the chain side crank arm with a thread (clockwise).

(2). The left pedal is attached to the other arm and has a left-hand thread (anti-clockwise).

Check the pedals before each ride to ensure they are tight. Riding with loose pedals can damage the threads that attach the pedal to the crank arm.

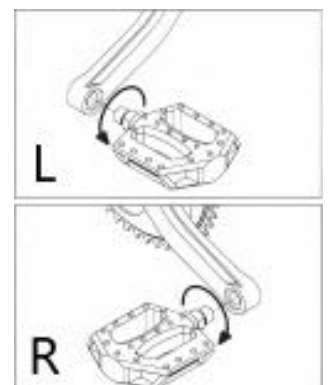
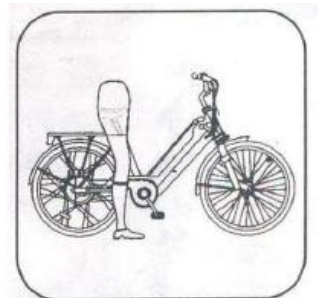

## Assemble the front wheel

Insert the wheel into the dropouts. Fit the safety locks and then the nuts on both sides. Turn the wheel and check that it is straight. If your bicycle is equipped with quick-release axles, ensure that the locking levers are correctly tensioned and in the closed position.

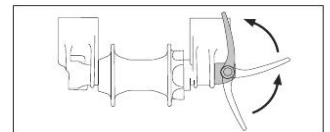
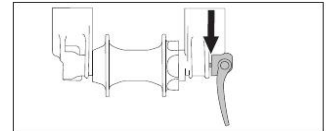
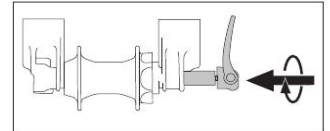
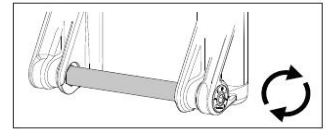
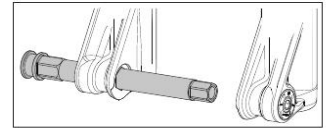

## Using your electric bicycle

Your electric bike is powered by a motor integrated into the rear wheel hub or a MID motor and cannot be driven directly with the throttle. The motor is powered by a battery. The amount of power supplied to the motor and, therefore, the acceleration force of the electric bike, is controlled by you according to the electric assist mode you choose.

### Electric assistance

You must switch on the battery to use the electric bicycle in electric assist mode.

In electric assist mode, assistance is activated when you pedal forwards and stops when you stop pedalling. In other words, assistance is activated whenever you pedal. You do not need to pedal hard. Simply apply light pressure to the pedals continuously to maintain the flow of current. When one of the brakes is applied, the electric assist automatically stops, allowing the electric bicycle to slow down and come to a stop. The electric assist automatically deactivates when the electric bicycle reaches the maximum speed of 25 km/h.

### Charge your battery

Fully charge the battery before your first use and after each use, especially after a long journey.

The charger connects directly to the battery via a round connector (RCA or XLR) or the same three-pin plug as the bicycle's power cable. You must first connect the charger to the bicycle and then to the power outlet.

**NEVER CONNECT THE POWER CABLE FROM A WALL SOCKET DIRECTLY TO THE BATTERY! YOU MUST USE YOUR CHARGER!**

The charger light will turn red when charging and green when finished. When the charger light turns green, keep the bike charging for 1 to 2 hours to ensure the battery has a longer life. Then unplug your charger from the battery and the power outlet.

Always charge your battery before it is completely discharged. If your battery is completely discharged, it may not recharge. A good way to prevent this from happening is to turn it off with the key and then remove it so that it does not accidentally remain on.

To unlock the battery, press the key lightly and turn it to the left. You can then remove it. Press and turn to the right to lock it.

The red button on the top of the battery shows the power level when pressed. The first light only comes on when the battery is too low to use the bicycle. The next

light indicates low, medium or full. The lights on the handlebars also show the level.

Remember, the sooner you charge the battery after use, the longer it will last.

The lithium battery is manufactured with circuits that prevent overcharging and excessive discharging.

The battery charger is designed specifically for the bicycle; attempting to charge the battery with any other charger will void the warranty.

It is important that the user follows the instructions on the battery charger label.

## How to fold your bicycle?

Press the folding release button and fold the handlebars down. Pull the pedal folding lever outwards, then fold the pedals up or down. Raise the kickstand. Open the frame folding lock and then fold it to the left.

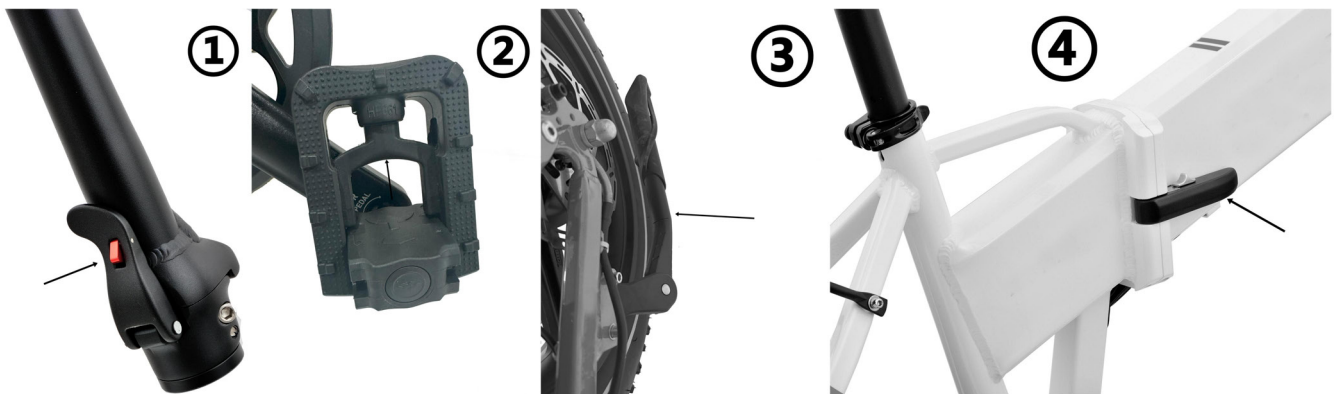

## Using the display

### Definition of the buttons

There are four buttons on the remote control, including:

1. ON/OFF
2. Up/Front light
3. Down/6 KM
4. Mode button

### For better use

1. Obey traffic laws.
2. Always keep both hands on the handlebars.
3. Always charge the battery after use.
4. Do not let your battery run completely flat.
5. Remember to turn off the bike using the key when you stop.
6. Always remove the key after use. If you leave it on, the battery will slowly discharge.
7. Under normal conditions (concrete and asphalt roads with no air resistance and an approximate temperature of 25°, battery capacity attenuation  $\leq 5\%$ ), the distance travelled per charge is at least 30km.
8. Wear a helmet when riding your electric bike.
9. Check the bike's screws and bolts frequently.

### Luggage rack information

1. The indicated load capacity for the rear rack is 25 kg. Do not overload. The maximum tyre size that fits on the rear rack is 27.5 inches.
2. If there is no rear rack on the bicycle, do not add one yourself.
3. The rear luggage rack cannot be used to carry a trailer.
4. When placing a load on the rear luggage rack, the reflector or lights must not be blocked. The load must be distributed evenly across the luggage rack.
5. The user is not permitted to modify the luggage rack themselves.
6. The user must understand that when the luggage rack is full, this will affect the overall handling of the bicycle.
7. The user must load the luggage rack according to the manufacturer's instructions. There is no built-in safety strap, and using a rope could cause it to get caught in the wheel.
8. The load can only be secured to the luggage rack.
9. The luggage rack is not suitable for attaching a child seat.

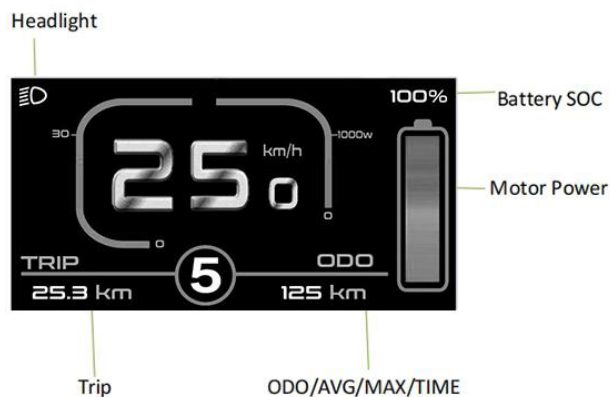

# The relationship between the person and the electric bicycle

**Frame Sizing Guide**



Approximate Rider Leg Length	Suggested Frame Size for Racing/Touring Bicycle	Suggested Frame Size for Mountain or Hybrid Bicycle
61-69cm / 24-27 inches	-	37cm / 14.5 inches
66-76cm / 26-30 inches	-	43cm / 17 inches
71-79cm / 28-31 inches	50cm / 19.5 inches	45cm / 18 inches
76-84cm / 30-33 inches	55cm / 21.5 inches	50cm / 19.5 inches
79-86cm / 31-34 inches	57cm / 22.5 inches	52cm / 20.5 inches
81-89cm / 32-35 inches	60cm / 23.5 inches	53-56cm / 21-22 inches
86-94cm / 34-37 inches	63cm / 25 inches	58-60cm / 23-23.5 inches

## Adjustments and maintenance

- Your ebike is designed for normal roads and for use by one person. Using your ebike for extreme manoeuvres, such as extreme off-road use, jumping or carrying excessive weight, will damage the electric bike and could cause serious injury.
- Do not use high-pressure water to clean the bicycle, as this could enter the motor or cables and cause rust or minor short circuits. Use a damp cloth with a neutral detergent to clean the body of the bicycle. Do not use an alkaline base or caustic detergent as rust removers, as these could damage or cause malfunctions in the body of the bicycle.
- Avoid parking your e-bike outside when it is raining or snowing. When you finish a journey in rainy or snowy conditions, bring the bicycle indoors and use a dry cloth to remove any moisture.
- During daily use, keep the control unit clean and dry, and keep it away from water, vibration, or contamination, otherwise it could be damaged.

### **WARNING!**

Do not over-lubricate. If oil gets onto the tyres or brakes, it can reduce braking ability and increase braking distance. This can cause accidents.

- The chain can stain the tyre with excess oil. Clean excess oil from the chain. Keep oil away from the surface of the pedals.
- Use soap and hot water to clean all oil from the tyre, brakes, pedals and tyre. Rinse with water and dry thoroughly before use.
- Use a light oil (20W) and follow the instructions for lubricating the bicycle:

Pedal	Every 6 months	Apply 4 drops of oil where the pedal shaft inserts into the pedal.
Chain	Every 6 months	Put 1 drop of oil on each roller of the chain.
Rear panel	Every 6 months	Contact a professional technician.
Engine	Every 12 months	Contact a professional technician.

## Battery maintenance and charging instructions

1. Charge the battery between 6 and 10 hours after the charge drops to 50%-70%, this will extend the battery life. Leaving the battery discharged for long periods of time could reduce its life. Perform full charges after each long-distance journey. Do not charge the battery for more than 10 hours in summer, as the battery may overheat.
2. Recharge the battery once a month when the bicycle is in storage.
3. Recommended charging temperature: 0° ~ 45°.
4. The battery may not recharge fully if the temperature is outside the range. If the charger indicator does not work when the battery is fully charged, contact the seller for immediate maintenance.
5. Do not shake or knock the charger. Keep it away from water.
6. Do not use a different charger, as it could burn the battery and cause damage.
7. Battery storage conditions: keep it in a clean, cool, dry place, away from draughts and at a temperature between 0° and 45°. Do not expose it to sunlight, fire or water, and do not mix the battery with corrosive substances during transport and storage.
8. Ensure that the switch on the top of the battery casing is in the “on” position when charging.
9. Ensure that there are no power cuts during charging as this could damage the battery.
10. Do not remove the key when riding the bicycle at high speed.

## Dispose of the battery

### WARNING

NEVER dispose of the battery in a regular bin. Take the used battery to an appropriate location for recycling. Contact the relevant authority in your area for information.

The battery must be removed during maintenance and must not be tampered with.

## Faults and troubleshooting

No	Errors	Causes	Solutions
1	The battery indicator lights up, but the bicycle does not work.	<ol style="list-style-type: none"> <li>1) The power cable is not properly connected to the battery.</li> <li>2) The brake cut-off is activated or defective.</li> <li>3) The speed sensor is set too low.</li> <li>4) Blown fuse.</li> <li>5) Loose motor cable connector.</li> <li>6) Loose connectors.</li> <li>7) Broken cable.</li> <li>8) Throttle disconnected or defective.</li> </ol>	<ol style="list-style-type: none"> <li>1) Correctly connect the power cable to the battery.</li> <li>2) Deactivate the brake cut-off or replace it.</li> <li>3) Adjust the speed sensor.</li> <li>4) Replace the fuse.</li> <li>5) Check the motor cable connector.</li> <li>6) Check all connectors.</li> <li>7) Inspect all cables.</li> <li>8) Activate the accelerator or replace it.</li> </ol>
2	The bicycle works, but the battery indicator does not light up.	<ol style="list-style-type: none"> <li>1) Loose connectors.</li> <li>2) Damaged cables.</li> <li>3) Faulty battery indicator.</li> </ol>	<ol style="list-style-type: none"> <li>1) Check the accelerator connectors.</li> <li>2) Inspect all cables.</li> <li>3) Replace the battery indicator.</li> </ol>
3	The bicycle has reduced speed and/or range.	<ol style="list-style-type: none"> <li>1) The speed sensor is not adjusted</li> <li>2) Low battery charge</li> <li>3) Faulty batteries</li> <li>4) Low tyre pressure</li> <li>5) The brakes are rubbing against the wheel rim</li> </ol>	<ol style="list-style-type: none"> <li>1) Adjust the speed sensor.</li> <li>2) Charge the batteries for the recommended time.</li> <li>3) Replace the batteries.</li> <li>4) Inflate the tyres to the recommended pressure.</li> <li>5) Adjust the brakes and/or wheel rim.</li> </ol>
4	The bicycle has intermittent power.	<ol style="list-style-type: none"> <li>1) Loose connectors</li> <li>2) Loose fuse</li> <li>3) Damaged cables</li> </ol>	<ol style="list-style-type: none"> <li>1) Check all connectors.</li> <li>2) Check the fuse connector.</li> <li>3) Inspect all cables.</li> </ol>
5	The charger light is not working.	<ol style="list-style-type: none"> <li>1) Faulty power socket.</li> <li>2) The charger is not properly plugged into the wall or battery.</li> <li>3) The charger light or charger is faulty.</li> </ol>	<ol style="list-style-type: none"> <li>1) Try another power outlet.</li> <li>2) Check all plugs.</li> <li>3) Replace the charger.</li> </ol>
6	The charger completes charging in an unusually short time.	<ol style="list-style-type: none"> <li>1) Faulty charger</li> <li>2) Faulty batteries</li> </ol>	<ol style="list-style-type: none"> <li>1) Replace the charger</li> <li>2) Replace the batteries</li> </ol>
7	The chain jumps off the sprocket or chainring.	<ol style="list-style-type: none"> <li>1) Off-centre chainring.</li> <li>2) Loose chainring.</li> <li>3) Bent or broken chainring teeth.</li> <li>4) Misalignment in the lateral movement of the rear or front derailleur.</li> </ol>	<ol style="list-style-type: none"> <li>1) If possible, readjust or replace.</li> <li>2) Tighten the mounting bolts.</li> <li>3) Repair or replace the chainring/chainring set.</li> <li>4) Adjust the derailleur travel.</li> </ol>
8	The gears are not functioning correctly.	<ol style="list-style-type: none"> <li>1) Derailleur cables jammed/stretched/damaged</li> <li>2) Front or rear derailleur incorrectly adjusted</li> <li>3) Indexed gear shift incorrectly adjusted</li> </ol>	<ol style="list-style-type: none"> <li>1) Lubricate/tighten/replace the cables</li> <li>2) Adjust the derailleur</li> <li>3) Adjust the indexing</li> </ol>

# Periodic inspection checklist

Before each trip, it is important to carry out the following safety checks:

## 1. Brakes

Ensure that the front and rear brakes are working properly.

Ensure that the brake pads are not excessively worn and are correctly positioned in relation to the tyres.

Ensure that the brake control cables are lubricated, correctly adjusted and show no obvious signs of wear.

Ensure that the brake levers are lubricated and securely attached to the handlebars.

Ensure that your hands and fingers are not on the brake discs after braking.

## 2. Wheels and tyres.

Ensure that the tyres are inflated within the recommended limit, as indicated on the side of the tyre.

Ensure that the tyres have tread and do not show any bulges or excessive wear.

Ensure that the wheels turn correctly and do not show any wobbling or obvious deformation.

Ensure that all wheel spokes are tight and not broken.

Check both tyres regularly and replace them with new ones if necessary in the event of brake failure.

## 3. Steering

Ensure that the handlebars and stem are correctly adjusted and tightened, and allow for proper steering.

Ensure that the handlebars are correctly adjusted in relation to the forks and the direction of travel.

Check that the steering lock mechanism is correctly adjusted and tightened.

If the bicycle is equipped with extensions at the ends of the handlebars, ensure that they are correctly positioned and tightened, as when loaded with the handlebars, the rider's response to steering and braking may be adversely affected.

## 4. Frame and fork

Check that the frame and fork are not bent or broken.

If either is bent or broken, it must be replaced.

## 5. Chain

Ensure that the chain is lubricated, clean, and functioning properly.

Consult a qualified technician to adjust the chain to the correct tension.

Special care is required in wet or dusty conditions.

## 6. Bearings

Ensure that all bearings are lubricated, operate freely, and do not exhibit excessive movement, squeaking, or rattling.

Check the bearings on the handlebars, wheels, pedals, and bottom bracket, and lubricate them regularly.

## 7. Cranks and pedals

Ensure that the pedals are securely fastened to the cranks.

Ensure that the cranks are securely fastened to the axle and are not bent.

## 8. Accessories

Ensure that all reflectors are correctly positioned and not covered.

Ensure that all other bicycle accessories are correctly attached and functioning properly.

Ensure that the rider is wearing a helmet.

Ensure that the maximum inflation pressure for conventional or tubular tyres is the lower of the maximum pressure recommended on the rim and that of the tyre.

## 9. Engines

Ensure that you do not touch the engines with your hands or fingers after driving.

**WARNING 1:** If any safety-critical component needs to be replaced, contact an authorised dealer for a genuine replacement part.

**WARNING 2:** Like all mechanical components, the EPAC is subject to wear and high stresses. Different materials and components may react to wear or stress fatigue in different ways. If a component has exceeded its service life, it may fail suddenly, which could cause injury to the rider. Any form of crack, scratch or discolouration in areas subject to high stress indicates that the component has reached the end of its service life and must be replaced.

**WARNING 3:** This assembly and operating manual must remain an integral part of the electric bicycle. When transferring the electric bicycle to other persons, please enclose this manual, as it contains important safety and operating instructions. Anyone using the electric bicycle must read the safety and operating instructions carefully before use.

## Anti-tampering

Definition of tampering: Preventing unauthorised modification of the EPAC transmission system as far as possible, so as not to affect its technical requirements and functional safety specifications.

Responsibility for tampering: Once the consumer or distributor has tampered with any part of the bicycle, we will not assume any risk or responsibility arising from this.

### Caution!

This assembly and operating manual must remain an integral part of the electric bicycle. When transferring the electric bicycle to other persons, please enclose this manual, as it contains important safety and operating instructions. Anyone using the electric bicycle must carefully read the safety and operating instructions before using it.

Changes to the images, data, descriptions, and specifications contained in this manual may not be separately notified due to the continuous improvement of our corporate products.

Tampering: To prevent, as far as possible, unauthorised modification of the EPAC drive system, so that the technical requirements and functional safety specifications are not affected.

Definition of tampering: To prevent unauthorised modification of the EPAC drive system as far as possible, so that the technical requirements and functional safety specifications are not affected.

Responsibility for tampering: Once the consumer or distributor has tampered with any part of the bicycle, we will not assume any risk or responsibility arising from this.

## User services and privacy policies

### How to access and control your personal information

1. We will endeavour to take appropriate technical measures to ensure that you can access, update, and correct your registration information or other personal information provided when using our services. When accessing, updating, correcting, and deleting the above information, we may ask you to provide a control panel design to ensure user security.
2. We take appropriate security measures to protect data against unauthorised access, alteration, disclosure, or destruction. These measures include an internal review of our data collection, storage, and processing practices, as well as security measures (including appropriate encryption and physical security measures to prevent unauthorised access to our personal data storage systems).
3. As a result of your own actions or force majeure events that may lead to the disclosure, revelation, acquisition, use or transfer of content that may affect your privacy or what you consider to be private information, you are solely responsible for any adverse consequences, and we are not liable for them.

## Purchase card

Fill in and keep for your records  
(Keep your proof of purchase for warranty claims)

Full name:

Date of purchase:

Place of purchase:

Model name:

Wheel size:

Colour:

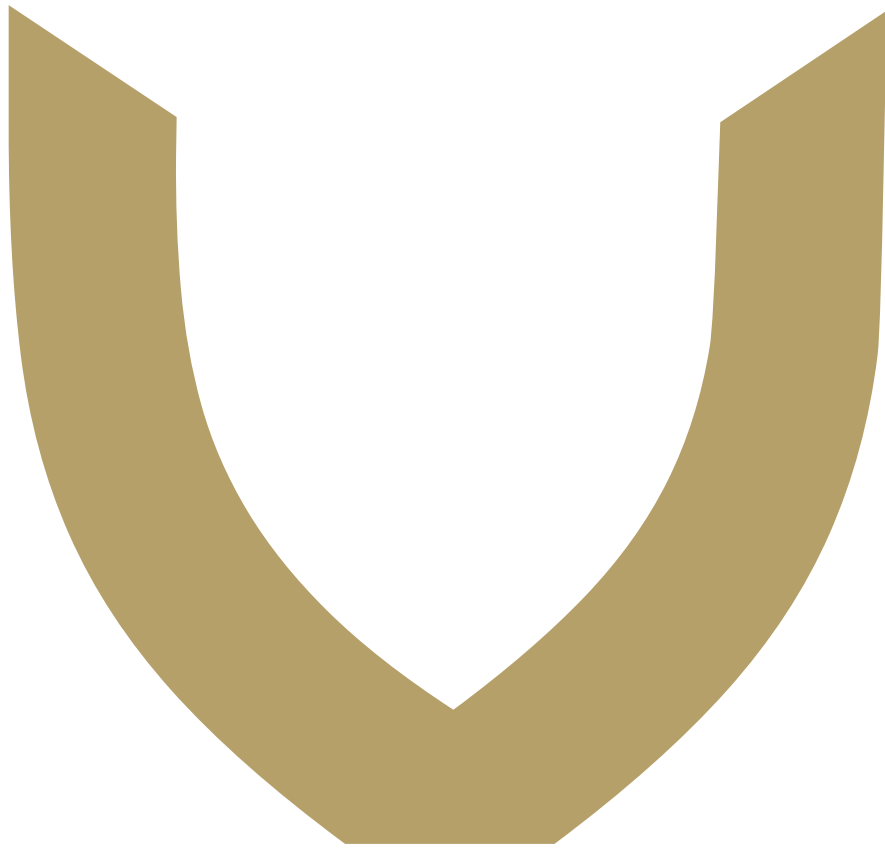

**VIKETORY**

Freedom is Victory