

Features

- Dim-to-Off with Standby Power ≤ 0.5 W
- Always-on Auxiliary Power: 12Vdc, 200mA
- Thermal Sensing and Protection for LED Module
- Full Power at 50-100% Max Current (Constant Power)
- Flicker-Free
- Push Dimming / DALI Dimmable
- Low Dimming Level to 5%
- Suitable for Class I and Class II Luminaires
- Suitable for Built-in Use
- Class P, UL Listed Versions Available (See Note 4)
- 5 Years Warranty



Description

The *LUD-040SxxxBSF* series is a 40W, constant-current, programmable IP20 LED driver that operates from 90-305 Vac input with excellent power factor. Created for dimmable panel lights and linear lights, it provides good dimming accuracy down to 5% output, plus a dim-to-off mode with low standby power. The high efficiency of these drivers and slim metal case enables them to run cooler, significantly improving reliability and extending product life. To ensure trouble-free operation, protection is provided against over voltage, short circuit, and over temperature of both the driver and the external LED array.

Models

Output Current Range	Full-Power Current Range (1)	Default Output Current	Input Voltage Range(2)	Output Voltage Range	Max. Output Power	Typical Efficiency (3)	Power Factor		Model Number(4)
							120Vac	220Vac	
17.5-750mA	350-750mA	700mA	90~305 Vac 127~300 Vdc	17~114 Vdc	40 W	90.0%	0.99	0.96	LUD-040S075BSF (5)
37.5-1500mA	750-1500mA	1050mA	90~305 Vac 127~300 Vdc	8 ~54 Vdc	40 W	89.5%	0.99	0.96	LUD-040S150BSF (6)

- Notes:** (1) Output current range with constant power at 40W.
 (2) Certified input voltage range: UL, FCC 100-277Vac or 127-300Vdc; otherwise 100-240Vac or 127-250Vdc (except PSE and KS).
 (3) Measured at a 220Vac input with 50% maximum output current and 100% maximum output voltage.
 (4) For UL Listed Class P models add suffix -00C0 (certified input voltage range: 120-277Vac or 127-250Vdc).
 (5) SELV output.
 (6) Class 2 and SELV output.

I-V Operating Area

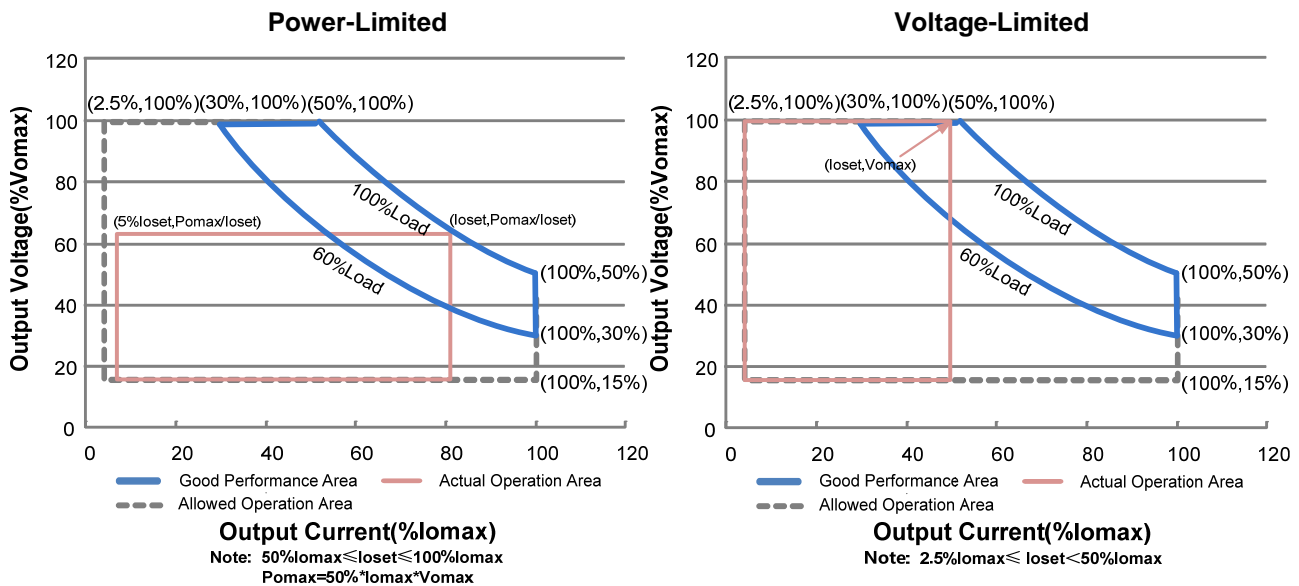

Input Specifications

Parameter	Min.	Typ.	Max.	Notes
Input Voltage	90 Vac	-	305 Vac	127~300 Vdc
Input Frequency	47 Hz	-	63 Hz	
Leakage Current	-	-	0.75 MIU	UL8750; 277Vac/ 60Hz
	-	-	0.70 mA	IEC60598-1; 240Vac/ 60Hz
Input AC Current	-	-	0.55 A	Measured at 100% load and 100 Vac input.
	-	-	0.3 A	Measured at 100% load and 220 Vac input.
Inrush Current(I^2t)	-	-	0.39 A ² s	At 220Vac input, 25°C Cold Start, Duration =328 μ s, 10%Ipk-10%Ipk. See Inrush Current Waveform for the details.
PF	0.90	-	-	At 100-277Vac, 60%-100% load(24-40W)
THD	-	-	20%	

Output Specifications

Parameter	Min.	Typ.	Max.	Notes
Output Current Tolerance	-5%Ioset	-	5%Ioset	At 100% load condition
Output Current Setting (Ioset) Range				
LUD-040S075BSF	75 mA	-	750 mA	
LUD-040S150BSF	150 mA	-	1500 mA	

Output Specifications (Continued)

Parameter	Min.	Typ.	Max.	Notes
Output Current Setting Range with Constant Power LUD-040S075BSF LUD-040S150BSF	350 mA 750 mA	- -	750 mA 1500 mA	
Total Output Current Ripple (pk-pk)	-	5%I _{omax}	10%I _{omax}	At 100% load condition, 20 MHz BW
Output Current Ripple at < 200 Hz (pk-pk)	-	1%I _{omax}	5%I _{omax}	At 100% load condition. Only this component of ripple is associated with visible flicker.
Startup Overshoot Current	-	-	10%I _{omax}	At 100% load condition
No Load Output Voltage LUD-040S075BSF LUD-040S150BSF	- -	- -	120 V 60 V	
Line Regulation	-	-	±1.0%	Measured at 100% load
Load Regulation	-	-	±1.5%	
Turn-on Delay Time	-	0.8 s	1.0 s	Measured at 120Vac input, 60%-100% load
	-	0.4 s	0.5 s	Measured at 220Vac input, 60%-100% load
Temperature Coefficient of I _o set	-	-	0.03%/°C	Case temperature = 0°C ~T _c max
12V Auxiliary Output Voltage	10.8 V	12 V	13.2 V	
12V Auxiliary Output Source Current	0 mA	-	200 mA	Return terminal is "Return-".

Note: All specifications are typical at 25°C unless otherwise stated.

General Specifications

Parameter	Min.	Typ.	Max.	Notes
Efficiency at 120 Vac input: LUD-040S075BSF LUD-040S150BSF	I _o =350 mA: 87.0% I _o =750 mA: 85.0%	89.0% 87.0%	- -	Measured at 100% load and steady-state temperature in 25°C ambient; (Efficiency will be about 1.0% lower if measured immediately after startup.)
	I _o =750 mA: 86.0% I _o =1500 mA: 83.0%	88.0% 85.0%		
Efficiency at 220 Vac input: LUD-040S075BSF LUD-040S150BSF	I _o =350 mA: 88.0% I _o =750 mA: 86.0%	90.0% 88.0%	- -	Measured at 100% load and steady-state temperature in 25°C ambient; (Efficiency will be about 1.0% lower if measured immediately after startup.)
	I _o =750 mA: 87.5% I _o =1500 mA: 84.5%	89.5% 86.5%		
Efficiency at 277 Vac input: LUD-040S075BSF LUD-040S150BSF	I _o =350 mA: 87.5% I _o =750 mA: 85.5%	89.5% 87.5%	- -	Measured at 100% load and steady-state temperature in 25°C ambient; (Efficiency will be about 1.0% lower if measured immediately after startup.)
	I _o =750 mA: 87.0% I _o =1500 mA: 84.0%	89.0% 86.0%		
Standby Power	-	-	0.5 W	Measured at 230Vac/50Hz; Dimming off

General Specifications (Continued)

Parameter	Min.	Typ.	Max.	Notes
MTBF	-	232,000 Hours	-	Measured at 220Vac input, 80%Load and 25°C ambient temperature (MIL-HDBK-217F)
Lifetime	-	95,000 Hours	-	Measured at 120Vac input, 80%Load and 60°C case temperature; See lifetime vs. Tc curve for the details
Operating Case Temperature for Safety Tc_s	-30°C	-	+85°C	UL8750
	-30°C	-	+87°C	IEC60598-1
Operating Case Temperature for Warranty Tc_w	-30°C	-	+70°C	Case temperature for 5 years warranty. Humidity: 10% RH to 90% RH; No Condensation
Storage Temperature	-30°C	-	+85°C	Humidity: 5% RH to 90% RH; No condensation
Dimensions Inches (L × W × H) Millimeters (L × W ×H)	14.57×1.18×0.83 360×30×21			
Net Weight	-	330 g	-	

Note: All specifications are typical at 25°C unless otherwise stated.

Dimming Specifications

Parameter	Min.	Typ.	Max.	Notes
DA/P, DA/P High Level	9.5 V	16 V	22.5 V	
DA/P, DA/P Low Level	-6.5 V	0 V	6.5 V	
DA/P, DA/P Current	0 mA	-	2 mA	
Dimming Output Range	5%loset	-	loset	50%lomax ≤ loiset ≤ 100%lomax
	2.5%lomax	-	loset	2.5%lomax ≤ loiset < 50%lomax

Note: All specifications are typical at 25 °C unless stated otherwise.

Standards Compliance

Safety Category	Standard
UL/CUL	UL 8750,UL1310,CAN/CSA-C22.2 No. 250.13,CAN/CSA-C22.2 No. 223-M91
CE & TUV & ENEC	EN61347-1 ⁽¹⁾ , EN61347-2-13
CB	IEC 61347-1, IEC 61347-2-13
PSE	J 61347-1, J 61347-2-13
KS	KS C 7655

Standards Compliance (Continued)

EMI Standards	Notes
EN 55015 ⁽²⁾	Conducted emission Test & Radiated emission Test
EN 61000-3-2	Harmonic current emissions Class C
EN 61000-3-3	Voltage Fluctuations & Flicker
FCC Part 15 ⁽²⁾	ANSI C63.4 Class B
	This device complies with Part 15 of the FCC Rules. Operation is subject to the following two conditions: [1] this device may not cause harmful interference, and [2] this device must accept any interference received, including interference that may cause undesired Operation.
J 55015	Limits and methods of measurement of radio disturbance characteristics of electrical lighting and similar equipment
EMS Standards	Notes
EN 61000-4-2	Electrostatic Discharge(ESD): 8 kV air discharge, 4 kV contact discharge
EN 61000-4-3	Radio-Frequency Electromagnetic Field Susceptibility Test-RS
EN 61000-4-4	Electrical Fast Transient/Burst-EFT
EN 61000-4-5	Surge Immunity Test: AC Power Line: line to line 1 kV
EN 61000-4-6	Conducted Radio Frequency Disturbances Test-CS
EN 61000-4-8	Power Frequency Magnetic Field Test
EN 61000-4-11	Voltage Dips
EN 61547	Electromagnetic Immunity Requirements Applies to Lighting Equipment
DALI Standards	Notes
DALI	IEC62386-101,102 & part of 207 ⁽³⁾

Notes: (1) This product meets all requirements for EN61347-1, Annex O (Double insulation). When the driver is energized, the allowed leakage current is perceptible but harmless.

(2) This LED driver meets the EMI specifications above, but EMI performance of a luminaire that contains it depends also on the other devices connected to the driver and on the fixture itself.

(3) Optional Commands Implemented: 242 (query short circuit), 243 (query open circuit).

Lifetime vs. Case Temperature

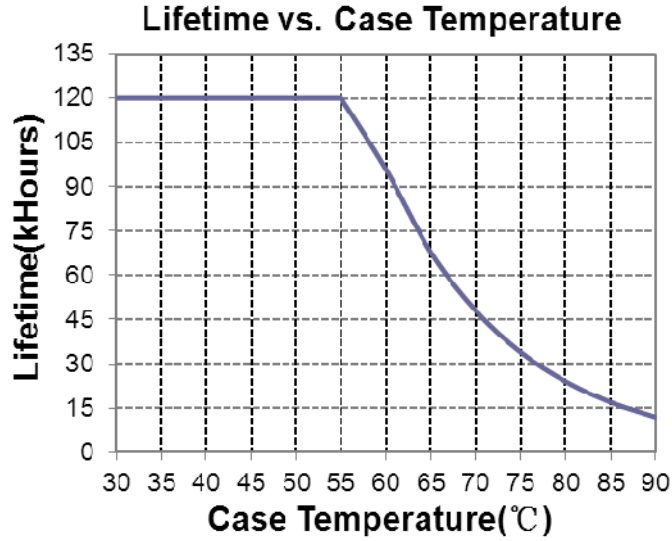

Inrush Current Waveform

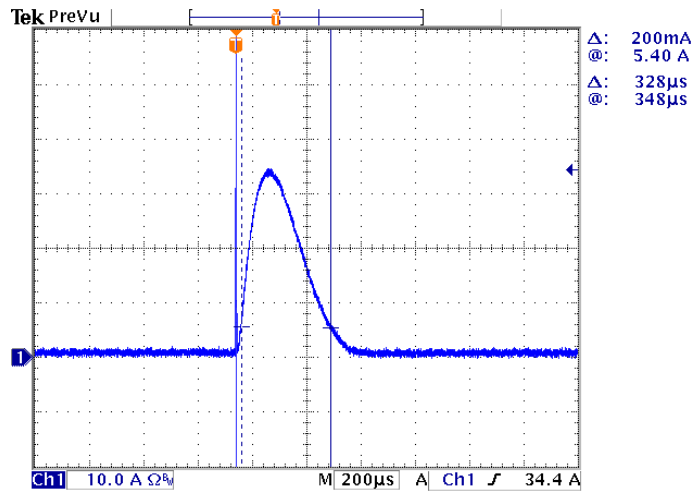

Efficiency vs. Load

LUD-040S075BSF($I_o=350mA$)
Efficiency vs. Output Voltage

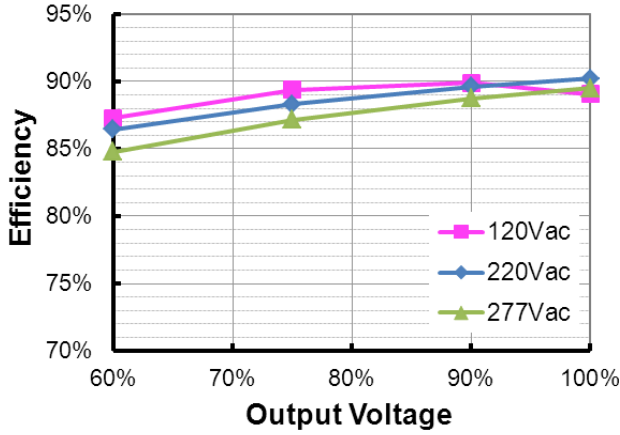

LUD-040S075BSF($I_o=750mA$)
Efficiency vs. Output Voltage

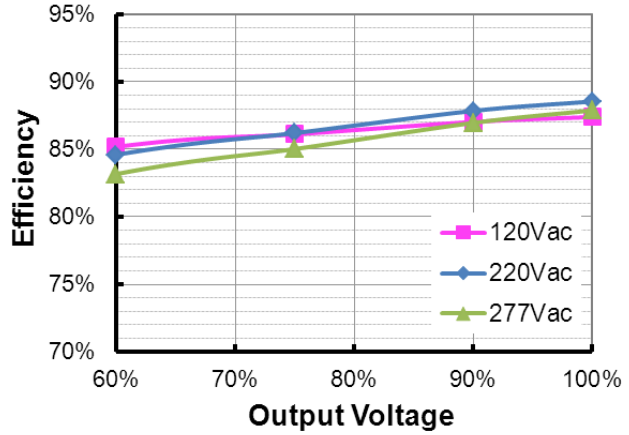

LUD-040S150BSF($I_o=750mA$)
Efficiency vs. Output Voltage

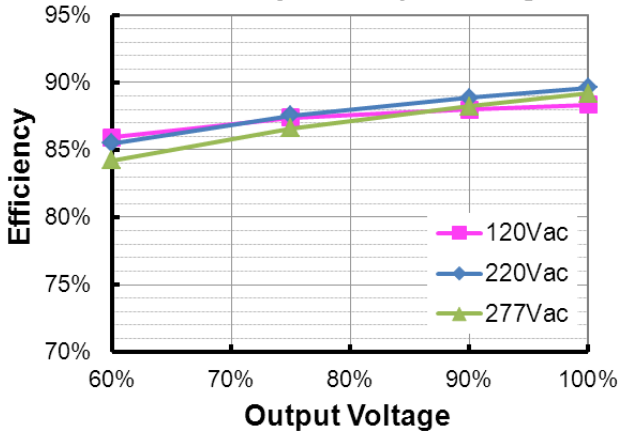

LUD-040S150BSF($I_o=1500mA$)
Efficiency vs. Output Voltage

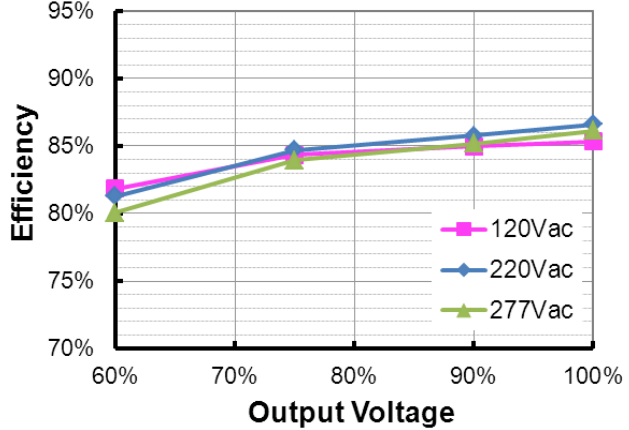

Power Factor

PF vs. Load

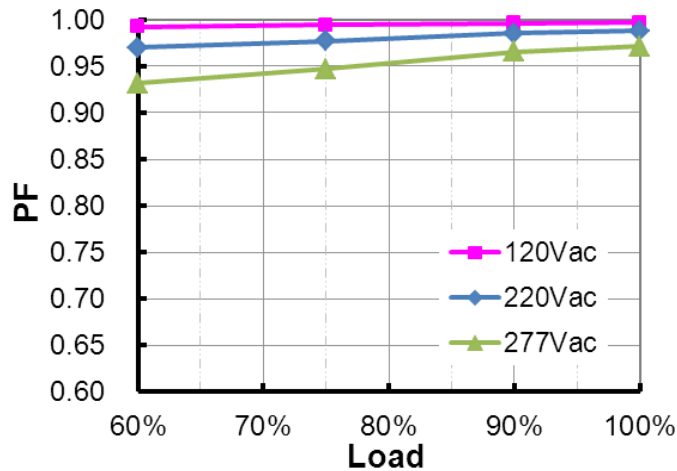

Total Harmonic Distortion

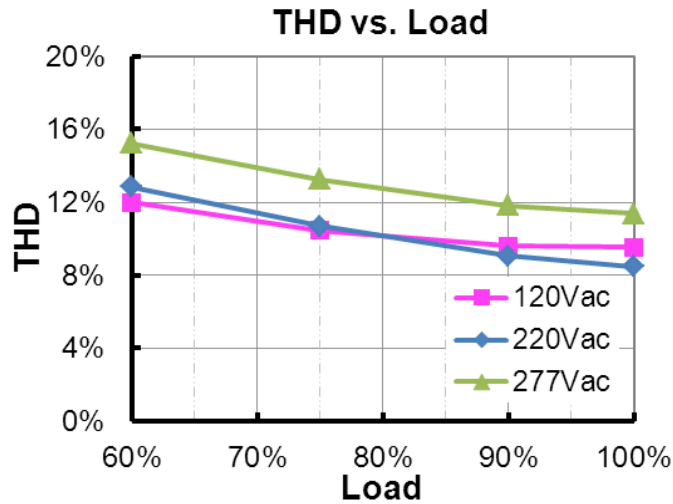

Protection Functions

Parameter	Min.	Typ.	Max.	Notes	
Over Temperature Protection	Decreases output current. Returning to normal after over temperature is removed.				
Short Circuit Protection	Auto Recovery. No damage will occur when any output is short circuited. The output shall return to normal when the fault condition is removed.				
Over Voltage Protection	Limits output voltage at no load and in case the normal voltage limit fails.				
External Thermal Protection NTC	R1	-	7.81 kOhm	-	When R_NTC falls below R1, External Thermal Protection is triggered, reducing output current until R2 is reached.
	R2	-	4.16 kOhm	-	When R_NTC is less than R2, output current is reduced to the programmed "Protection Current Floor."
	Protection Current Floor	5%loset	60%loset	100%loset	5%loset > Iomin (default setting is 60%)
		Iomin	60%loset	100%loset	5%loset ≤ Iomin (default setting is 60%)

Dimming

● DALI Dimming

The recommended implementation of the dimming control is provided below.

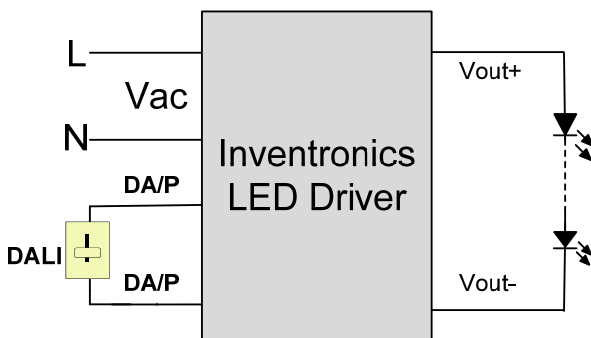

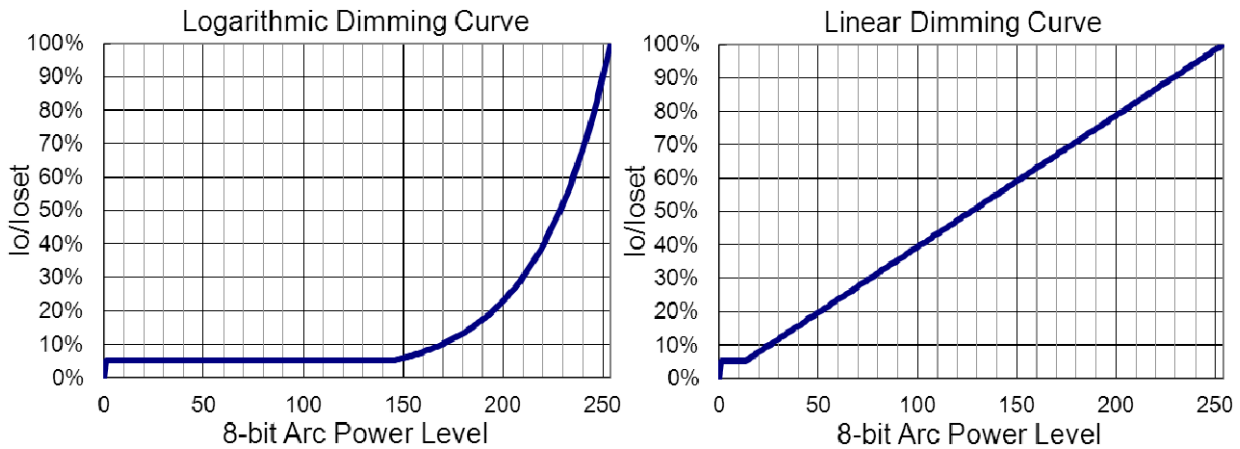

Implementation: DALI Dimming

● Push Dimming

Parameter		Min.	Typ.	Max.	Notes
Operated Input Voltage Range		90 V	-	264 V	
Dimming Output Range	LUD-040S075BSF LUD-040S150BSF	5%IoSet	-	IoSet	350 mA ≤ IoSet ≤ 750 mA 750 mA ≤ IoSet ≤ 1500 mA
	LUD-040S075BSF LUD-040S150BSF	17.5 mA 37.5 mA	-	IoSet	17.5 mA ≤ IoSet < 350 mA 37.5 mA ≤ IoSet < 750 mA
Short push		0.1 s	-	0.6 s	Switch the device on or off
Long push		0.6 s	-	3.6 s	Dim the device up or down 1% every 32ms(Default)
Long push		0.6 s	-	6.6 s	Dim the device up or down 1% every 64ms
Long push		10 s	-	-	All devices will be synchronized to the same status 100%
Long push		20 s	-	-	Change the fading time between 3s and 6s

Notes:

1. Automatically identify DALI mode or Push Dimming mode, push dimming and Dali function can't be used at the same time.
2. The device has a memory function. This is used, among other things, for storing the last dimming value in the event of interruptions in the power supply. When power returns, the LED is automatically restored to its previous operating state and dimmed to the last value.

Wire Connection Diagram

● DALI Dimming

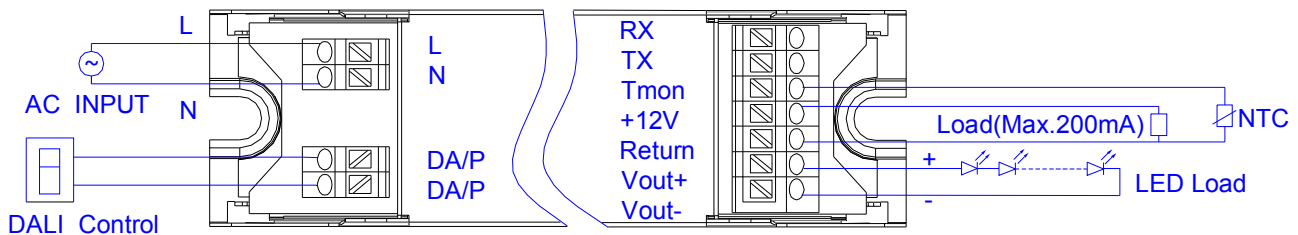

● **Push Dimming**

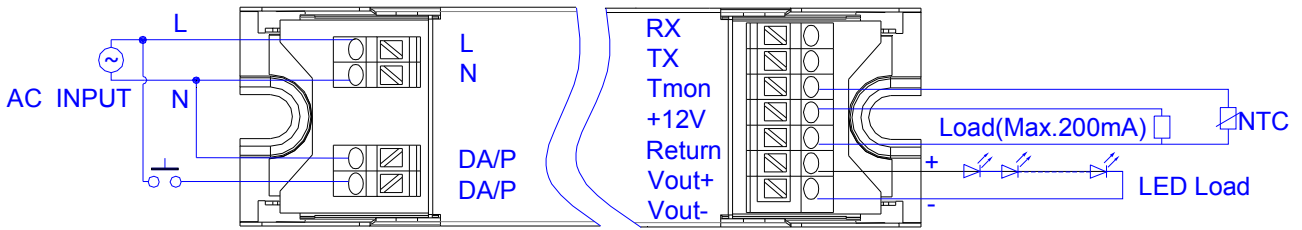

Programming Connection Diagram

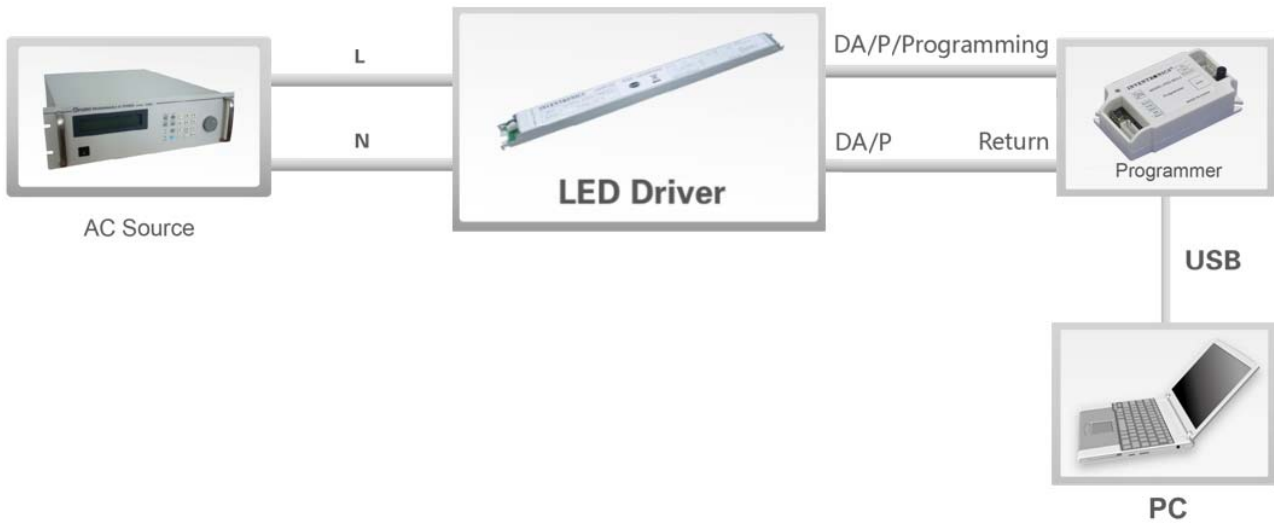

Note: The driver needs to be powered on during the programming process in this way.

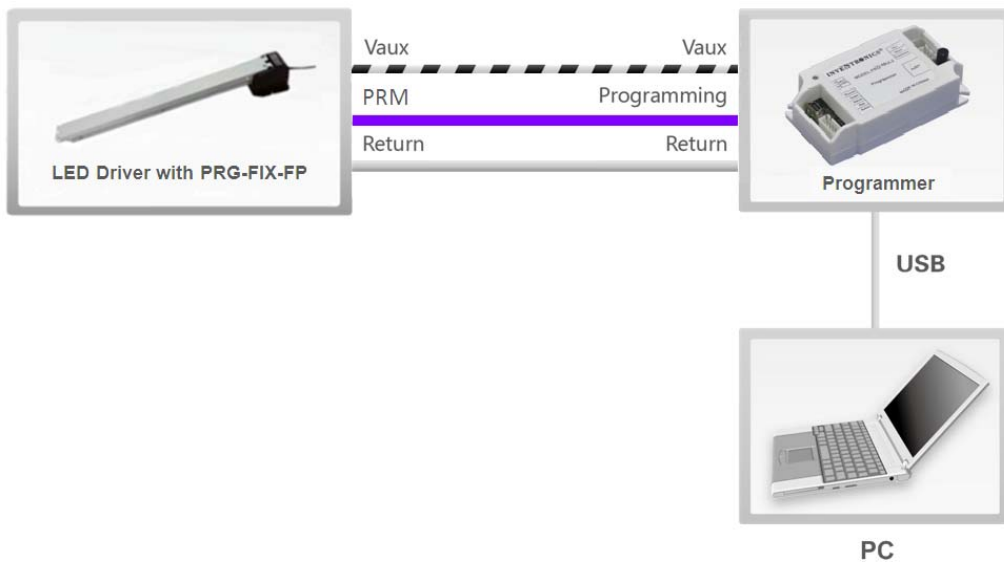

Note: The driver does not need to be powered on but needs a programming fixture during the programming process in this way.

- Please refer to [PRG-FIX-FP](#) (Programming Fixture) and [PRG-MUL2](#) (Programmer) datasheets for details.

Mechanical Outline

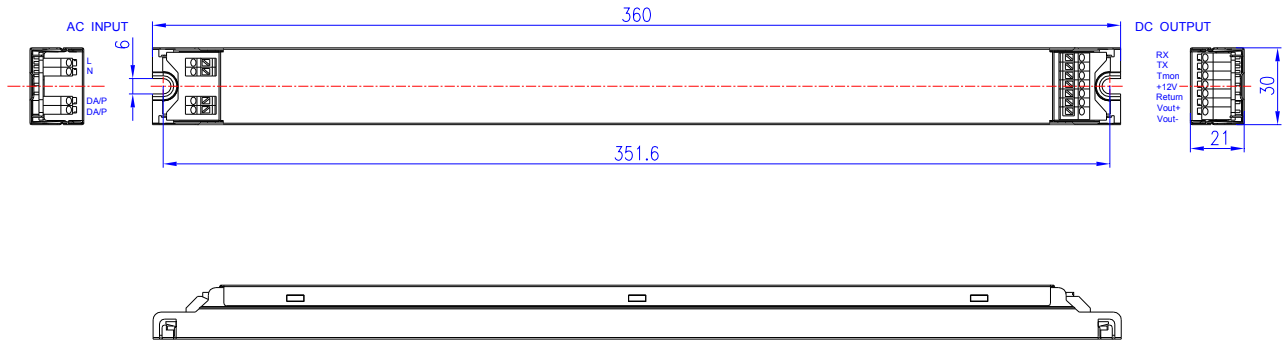

Unspecified tolerance:±1

RoHS Compliance

Our products comply with the European Directive 2011/65/EU, calling for the elimination of lead and other hazardous substances from electronic products.

Revision History

Change Date	Rev.	Description of Change		
		Item	From	To
2016-01-20	A	Datasheet Release	/	/
2016-02-25	B	KS Certificate	/	Added
		IP Rating	/	Added
		Note of EMI Standard	/	Updated
2016-10-24	C	I-V Operating Area	/	Corrected
		Operating Case Temperature for IEC Safety Tc_s	/	Added
		Programming Connection Diagram	/	Updated
2018-11-09	D	Safety certification logo	/	Updated
		Features	Class P, UL Listed Versions Available (See Note 4)	Added
		Features	5 Years Warranty	Added
		Models	(4) For UL Listed Class P models add suffix - 00C0 (certified input voltage range: 120-277Vac or 127-250Vdc).	Added
		Note of Operating Case Temperature for Warranty Tc_w	/	Updated
		Note of Storage Temperature	/	Updated
		Standards Compliance	/	Updated
		Link in the datasheet	/	Updated
2019-1-31	E	Features	DALI Dimming Control and Push Dimming Function	Push Dimming / DALI Dimmable
		PSE certificate	/	Added
		Notes of Models	(2) Certified input voltage range: UL, FCC 100-277Vac or 127-300Vdc; otherwise 100-240Vac or 127-250Vdc.	(2) Certified input voltage range: UL, FCC 100-277Vac or 127-300Vdc; otherwise 100-240Vac or 127-250Vdc (except PSE and KS).
		Standards Compliance	/	Updated