

Maximum safety and easy installation. SAFETY WITHOUT RINGS.

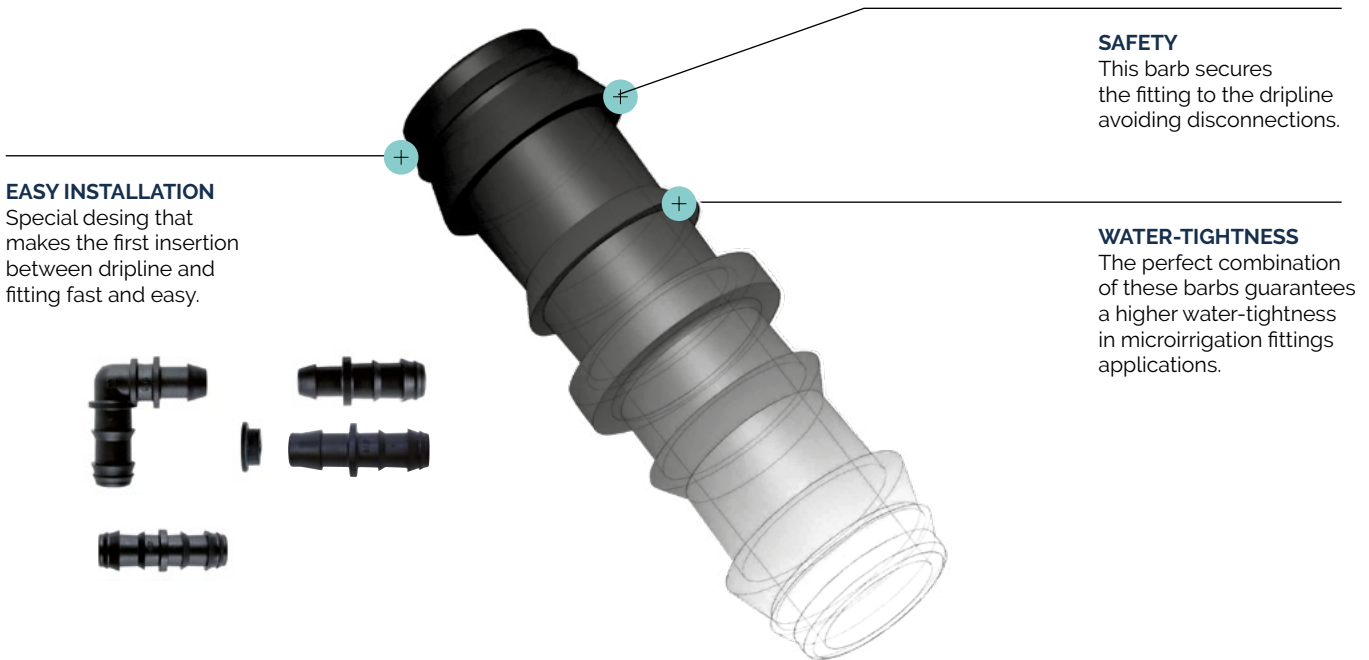

EASY INSTALLATION
Special desing that makes the first insertion between dripline and fitting fast and easy.

SAFETY
This barb secures the fitting to the dripline avoiding disconnections.

WATER-TIGHTNESS
The perfect combination of these barbs guarantees a higher water-tightness in microirrigation fittings applications.



+ Applications





















For agriculture:

- ▶ Irrigation installations where safety in the maintenance of work conditions is the most important factor.
- ▶ Irrigation areas on terraces or with abrupt topography.
- ▶ Subsurface drip irrigation.

For gardening:

- ▶ Sectors with mixed irrigation, where emitters and micro-sprinklers are placed.
- ▶ Green areas. Leisure and sport areas.
- ▶ Installations with variations in hydraulic work conditions.
- ▶ Green areas with subsurface drip irrigation.

+ Technical Data

AZUD FIT fittings		Model	un/box
	Barbed valve	12	600
		16	400
	Straight connector	12	1600
		16	1800
		17	1800
		18	700
		20	1000
	Reducing connector	16-12	1100
		20-16	600
	*Offtake connector for grommet (L)	16	2400
		20	700
	**Offtake connector with L grommet	16	800
		20	600
	**L grommet	L	1200
	Offtake connector for grommet (XL/B)	16	800
		20	600
	***Offtake connector with XL grommet	16	1100
		20	800
	***XL grommet	XL	1200
	**Offtake connector with B grommet	16	1000
	**B grommet	B	1200
	T-connector	12	700
		16	800
		16-12	400
		20	200
	L-connector	12	550
		16	600
		20	350
	Cross connector	16	500
	End plug	12	1200
		16	1600
	End clamp	16	800
		20	500
	Mixed connector	16 - 1/2"	1200
		16 - 3/4"	1000
		20 - 3/4"	300
		25 - 3/4"	250
	T-male thread connector	16 - 1/2"	750
		16 - 3/4"	600
	L-male thread connector	16 - 1/2"	600
		16 - 3/4"	1000
	On-line dripper	4	1000
	Microsprinkler	5	1000
	Button dripper	6.5	1000

*Punch with extractor Ø7
 **PVC, HDPE drill Ø16
 ***PVC drill Ø16,5, HDPE drill Ø16

* SISTEMA AZUD, S.A reserves the right to change the characteristics of these products without prior notice.