

Kom 3PH 30W

three phase track

4336-N, 4338-N

30W



BENEITO FAURE®

passion for led light

Instrucciones de montaje/ Assembly instructions/ Instructions de montage/ Montageanleitung/ Istruzioni di montaggio

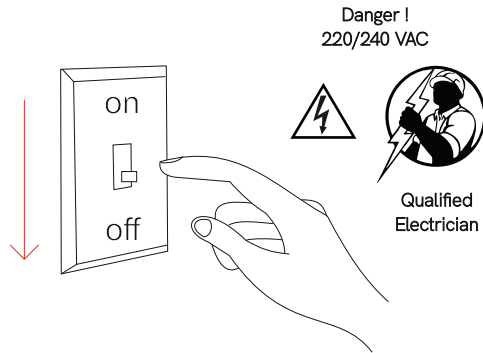

CCT
SWITCH

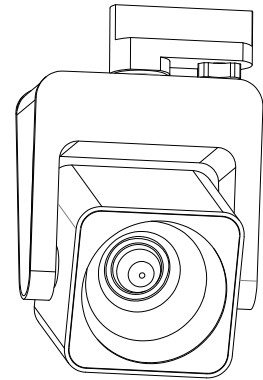

1.0

2.0

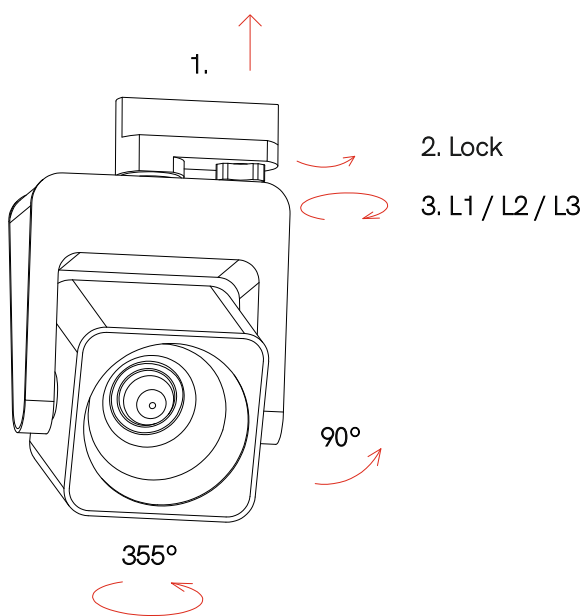

Track Right

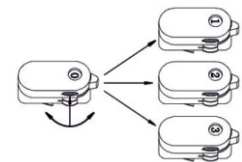
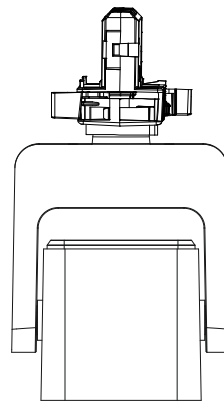
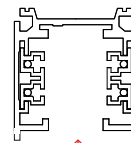

0 = OFF
1 = L1
2 = L2
3 = L3

3.0

4.0

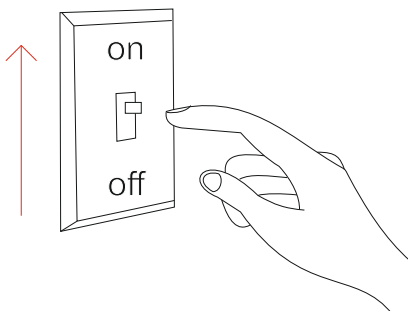

5.0



RoHS



3 YEARS WARRANTY

30.000 HOURS

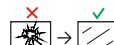

IP 20

220/240 VAC

UGR <19

PF >0,9



15°
24°
40°

50/60 Hz

+50°C
-20°C