

Instrucciones de montaje/ Assembly instructions/ Instructions de montage/ Montageanleitung/ Istruzioni di montaggio

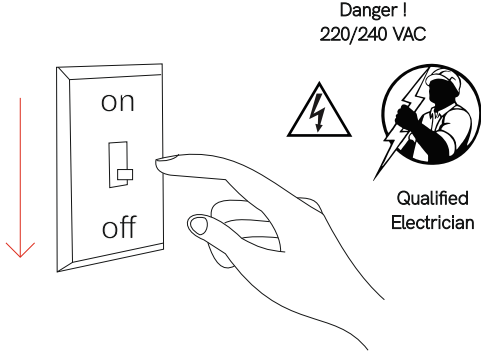

1.0

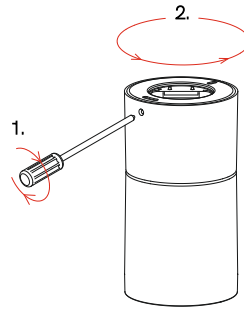

2.0

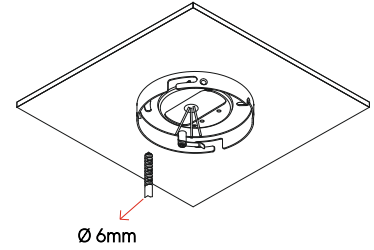

3.0

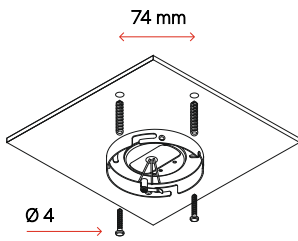

4.0

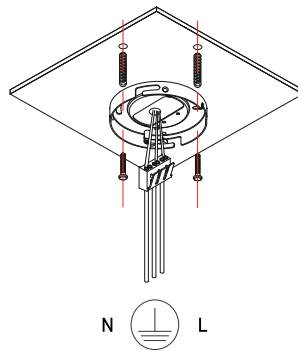

5.0

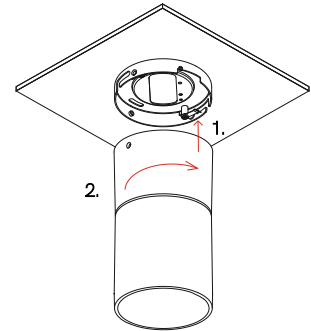

6.0

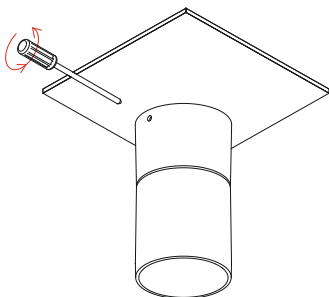

7.0

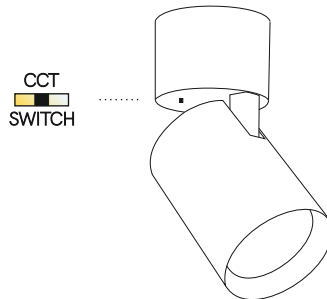

8.0 Disconnect the mains power before operating the power or CCT selection switch.

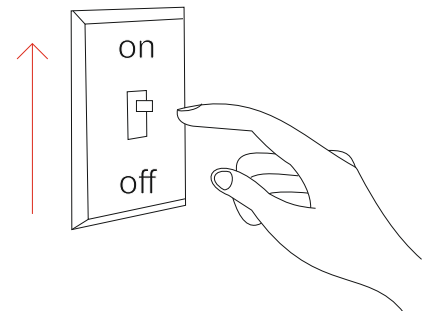

9.0