

# Quick

custom system  
48XXX1, 48XXX2, 48XXXC

Instrucciones de montaje/ Assembly instructions/ Instructions de montage/ Montageanleitung/ Istruzioni di montaggio



# Quick luminaires

48XXX1, 48XXX2, 48XXXC

20W, 30W, 41W, 51W, 61W, 71W

Instrucciones de montaje/ Assembly instructions/ Instructions de montage/ Montageanleitung/ Istruzioni di montaggio

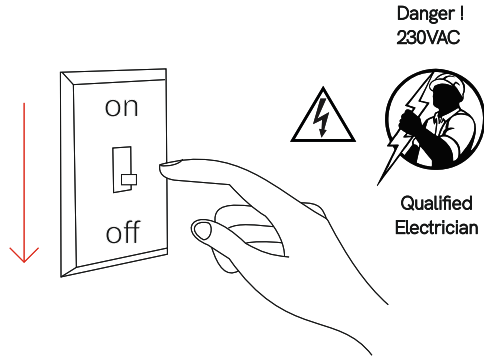

1.0

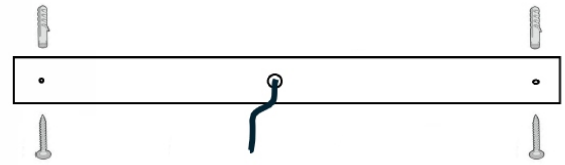

2.0

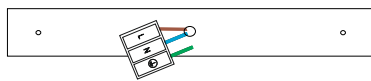

3.0 \* See the different smart connection options

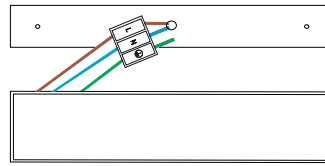

4.0

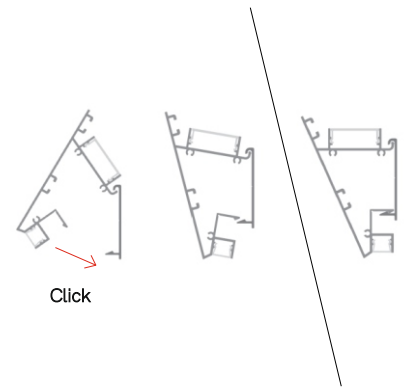

5.0



6.0

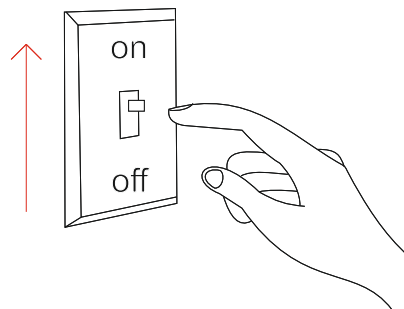

7.0

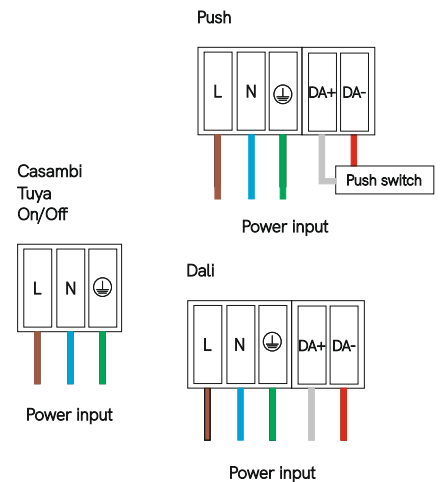

8.0 \* See the different smart connection options