

# Tot XL suspension/surface

suspension

4904, 4905

60W

Instrucciones de montaje/ Assembly instructions/ Instructions de montage/ Montageanleitung/ Istruzioni di montaggio

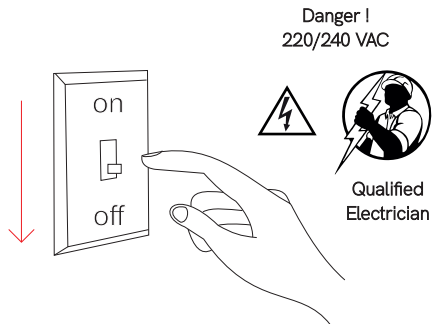

1.0

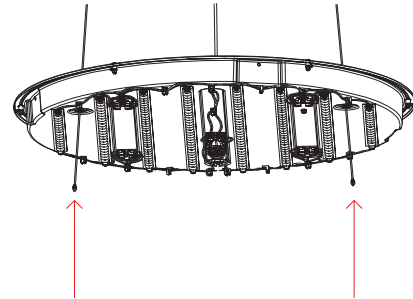

2.0

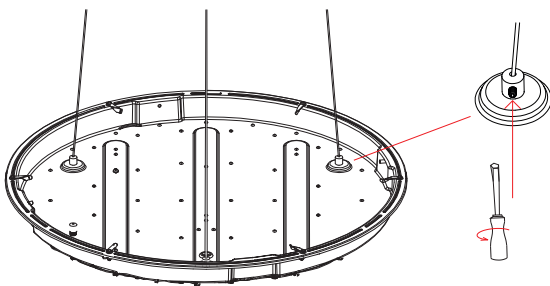

3.0

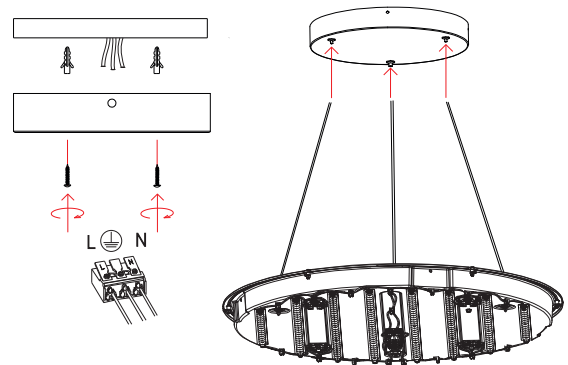

4.0

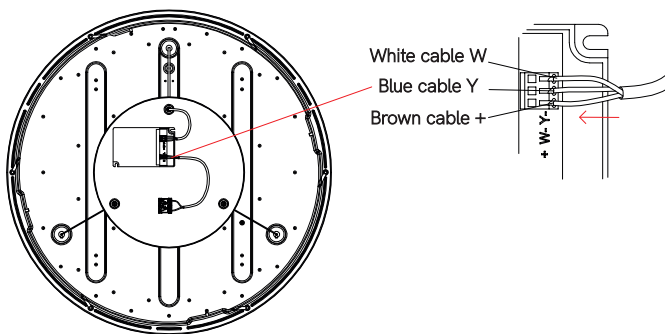

5.0

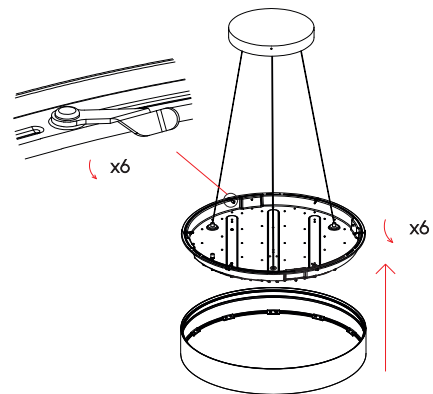

6.0

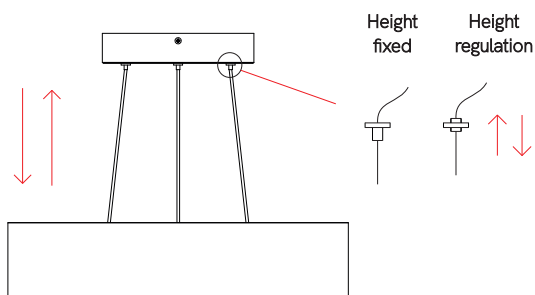



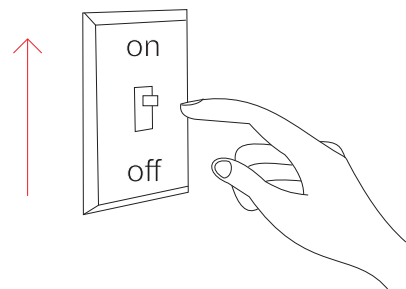

7.0



8.0



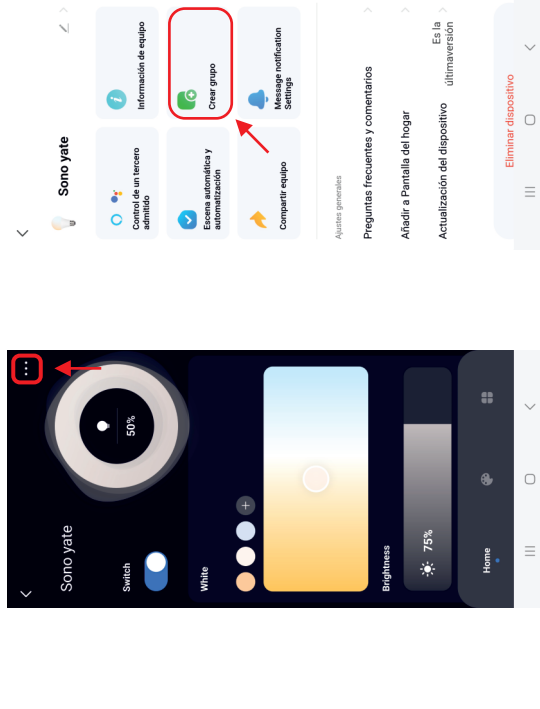
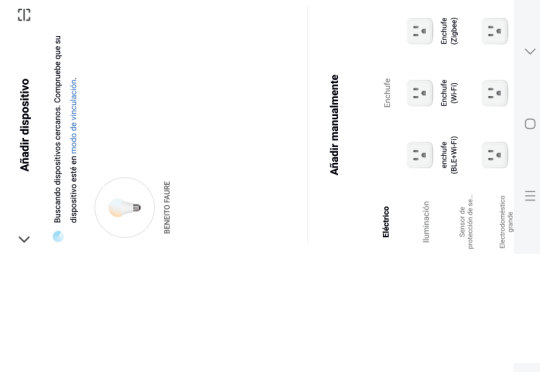
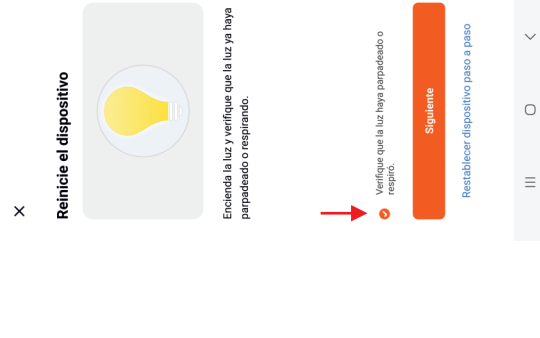
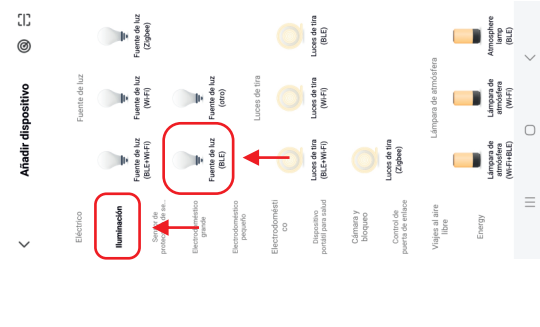
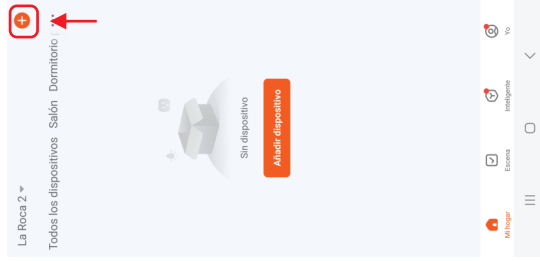

# Tuya Smart APP

-  1. Instalar la APP Tuya Smart y registrarse.
-  1. Download the Tuya Smart APP and log in.
-  1. Tuya app herunterladen und registrieren.
-  1. Installez votre Smart PPP et enregistrez-vous.
-  1. Scarica l'APP Tuya Smart e accedi.













**BENEITO FAURE**  
passion for led light













-  2. Activar el bluetooth y la ubicación en los ajustes del móvil o tablet. Pulsar el icono +
-  2. Activate the Bluetooth and the location of the mobile or tablet. Press the + icon.
-  2. Aktivieren Sie Bluetooth und den Standort des Mobiltelefons oder des Tablets. Drücken Sie das + Symbol, um ein Gerät hinzuzufügen (oben rechts)
-  2. Activation du Bluetooth et de la localisation dans les paramètres du portable ou de la tablette. Appuyez sur l'icône +
-  2. Attiva il Bluetooth e la posizione del cellulare o del tablet. Premi l'icona +

-  3. Seleccionar iluminación y fuente de luz (BLE).
-  3. Select the fixture and the light source (BLE).
-  3. Wählen Sie Beleuchtung, danach wählen Sie die Lichtquelle (BLE).
-  3. Choisir l'éclairage et la source de la lumière (BLE).
-  3. Seleziona illuminazione e la sorgente luminosa (BLE).

-  4. Conectar el dispositivo a la corriente, apagar y encender 3 veces esperando 1 segundo entre cada encendido y apagado, la luz parpadeará, marcar la confirmación y pulsar siguiente.
-  4. Connect the device to the power, turn it on and off 3 times waiting 1 second between each time, the light will flicker, mark confirm and press following.
-  4. Schalten Sie das Gerät ein und schalten Sie es dreimal ein und aus, dazwischen warten Sie jeweils 1 Sekunde. Sobald die Anzeigleuchte blinkt, bestätigen und auf weiter gehen.
-  4. Branchez l'appareil à l'alimentation électrique, éteindre et allumer 3 fois et attendre 1 seconde entre chaque manipulation, la lumière clignotera, marquer confirmer et cliquez sur suivant.
-  4. Collega il dispositivo alla corrente, accendilo e spegnilo 3 volte aspettando 1 secondo ogni volta, la luce lampeggerà, seleziona conferma e premi seguente.

-  5. Esperar a que detecte el dispositivo, una vez detectado nombrarlo y estará listo para controlarlo desde la app.
-  5. Wait for the device to be detected and once done, name it and it will be ready to use from the app.
-  5. Warten Sie, bis das Gerät erkannt wurde. Benennen Sie es anschließend, z.B. Licht Wohnzimmer. Nun kann es über die App verwendet werden.
-  5. Attendez que l'appareil soit détecté, une fois qu'il est détecté, et il sera prêt à le contrôler à partir de l'application.
-  5. Attendi che il dispositivo venga rilevato e, una volta terminato, assegnagli un nome e sarà pronto per l'uso dall'app.

-  6. Desde la app se pueden regular la temperatura de color y la intensidad de la luz. Para crear grupos pulsar el icono del lápiz.
-  6. From the app it is possible to regulate the colour temperature and the light intensity. To create a group, press the pencil icon.
-  6. Über die App können die Farbtemperatur und die Lichtintensität reguliert werden. Um eine Gruppe zu erstellen, drücken Sie auf das Stiftsymbol (rechts oben).
-  6. L'application vous permet de régler la température de couleur et l'intensité lumineuse. Pour créer des groupes, appuyez sur l'icône du crayon.
-  6. Dall'app è possibile regolare la temperatura del colore e l'intensità della luce. Per creare un gruppo, premi l'icona della matita.

-  7. Pulsar crear grupo y seleccionar los dispositivos para agregarlos.
-  7. Press "create group" and select the fixtures to be added.
-  7. Drücken Sie auf "Gruppe erstellen" und wählen Sie die Geräte aus, die hinzugefügt werden sollen.
-  7. Appuyez sur créer un groupe et sélectionnez les appareils à ajouter.
-  7. Premi "crea gruppo" e seleziona gli apparecchi da aggiungere.