

BEDIENUNGSANWEISUNG

mit Montageanweisungen

INSTRUCTIONS FOR USE

and installation

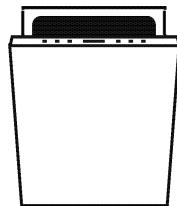

G6564.0V



Lesen Sie unbedingt die Gebrauchsanleitung und den Montageplan vor Aufstellung, Installation sowie Inbetriebnahme.

Please read the users and installation instructions carefully before installation of the appliance and before starting to use it.

Service und Kundendienst

Telefon: 0209 – 401 0

Email: kundendienst@kueppersbusch.de

Küppersbusch

FÜR KÜCHEN MIT STIL

CONTENTS

01	3	SAFETY INFORMATION
02	8	PRODUCT OVERVIEW
03	9	USING YOUR DISHWASHER
	9	Loading The Salt Into The Softener
	11	Basket Loading Tips
04	13	MAINTENANCE AND CLEANING
	13	External Care
	13	Internal Care
	16	Caring For The Dishwasher
05	17	INSTALLATION INSTRUCTION
	17	Power Connection
	18	Water Supply And Drain
	19	Connection Of Drain Hoses
	20	Positioning The Appliance
	20	Built-In Installation (for the integrated model)
06	25	TROUBLESHOOTING TIPS
	28	Availability Of Spare Parts
07	29	LOADING THE BASKETS
	31	Cutlery Rack Used Tips



NOTE:

- Reviewing the section on **Troubleshooting Tips** will help you solve some common problems by yourself.
- If you cannot solve the problems by yourself, please ask for help from a professional technician.
- The manufacturer, following a policy of constant development and updating of the product, may make modifications without giving prior notice.
- If lost or out-of-date, you can receive a new user manual from the manufacturer or responsible vendor.

SAFETY INFORMATION

⚠ WARNING

When using your dishwasher, follow the precautions listed below:

- Installation and repair can only be carried out by a qualified technician
- This appliance is intended to be used in household and similar applications such as:
 - staff kitchen areas in shops, offices and other working environments;
 - farm houses;
 - by clients in hotels, motels and other residential type environments;
 - bed and breakfast type environments.
- **This appliance can be used by children aged from 8 years and above and persons with reduced physical, sensory or mental capabilities or lack of experience and knowledge if they have been given supervision or instruction concerning use of the appliance in a safe way and understand the hazards involved.** Children shall not play with the appliance. Cleaning and user maintenance shall not be done by children without supervision. (For EN60335-1)
- This appliance is not intended for use by persons (including children) with reduced physical, sensory or mental capabilities, or lack of experience and knowledge, unless they have been given supervision or instruction concerning use of the appliance by a person responsible for their safety. (For IEC60335-1)

- Packaging material could be dangerous for children!
- Children should be supervised to ensure that they do not play with the appliance.
- This appliance is for indoor household use only. To protect against the risk of electrical shock, do not immerse the unit, cord or plug in water or other liquid.
- Please unplug before cleaning and maintenance the appliance .Use a soft cloth moisten with mild soap, and then use a dry cloth to wipe it again.
- If the supply cord is damaged, it must be replaced by the manufacturer or its service agent or a similarly qualified person in order to avoid a hazard.



Earthing Instructions

- This appliance must be earthed. In the event of a malfunction or breakdown, earthing will reduce the risk of an electric shock by providing a path of least resistance of electric current. This appliance is equipped with an earthing conductor plug.
- The plug must be plugged into an appropriate outlet that is installed and earthed in accordance with all local codes and ordinances.
- Improper connection of the equipment-earthing conductor can result in the risk of an electric shock.
- Check with a qualified electrician or service representative if you are in doubt whether the appliance is properly grounded.

- Do not modify the plug provided with the appliance if it does not fit the outlet.
- Have a proper outlet installed by a qualified electrician.
- Do not abuse, sit on, or stand on the door or dish rack of the dishwasher.
- Do not operate your dishwasher unless all enclosure panels are properly in place.
- Open the door very carefully if the dishwasher is operating, there is a risk of water squirting out.
- Do not place any heavy objects on or stand on the door when it is open. The appliance could tip forward.
- When loading items to be washed:
 - 1) Locate sharp items so that they are not likely to damage the door seal;
 - 2) Warning: Knives and other utensils with sharp points must be loaded in the basket with their points facing down or placed in a horizontal position.
- Some dishwasher detergents are strongly alkaline. They can be extremely dangerous if swallowed. Avoid contact with the skin and eyes and keep children away from the dishwasher when the door is open.
- Check that there are no detergent residues after completion of the wash cycle.
- Do not wash plastic items unless they are marked "dishwasher safe" or the equivalent.

- For unmarked plastic items not so marked, check the manufacturer's recommendations.
- Use only detergent and rinse agents recommended for use in an automatic dishwasher.
- Never use soap, laundry detergent, or hand washing detergent in your dishwasher.
- The door should not be left open, since this could increase the risk of tripping.
- During installation, the power supply must not be excessively or dangerously bent or flattened.
- Do not tamper with controls.
- The appliance needs to be connected to the main water valve using new hose sets. Old sets should not be reused.
- To save energy, in stand by mode, the appliance will switch off automatically after 15 minutes without any user interaction.
- The maximum number of place settings to be washed is 14.
- The maximum permissible inlet water pressure is 1MPa.
- The minimum permissible inlet water pressure is 0.04MPa.

Disposal

- For disposing of package and the appliance please go to a recycling center. Therefore cut off the power supply cable and make the door closing device unusable.



- Cardboard packaging is manufactured from recycled paper and should be disposed in the waste paper collection for recycling.
- By ensuring this product is disposed of correctly, you will help prevent potential negative consequences for the environment and human health, which could otherwise be caused by inappropriate waste handling of this product.
- For more detailed information about recycling of this product, please contact your local city office and your household waste disposal service.
- **DISPOSAL: Do not dispose this product as unsorted municipal waste. Collection of such waste separately for special treatment is necessary.**

PRODUCT OVERVIEW

❗ IMPORTANT:

To get the best performance from your dishwasher, read all operating instructions before using it for the first time.

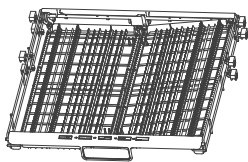
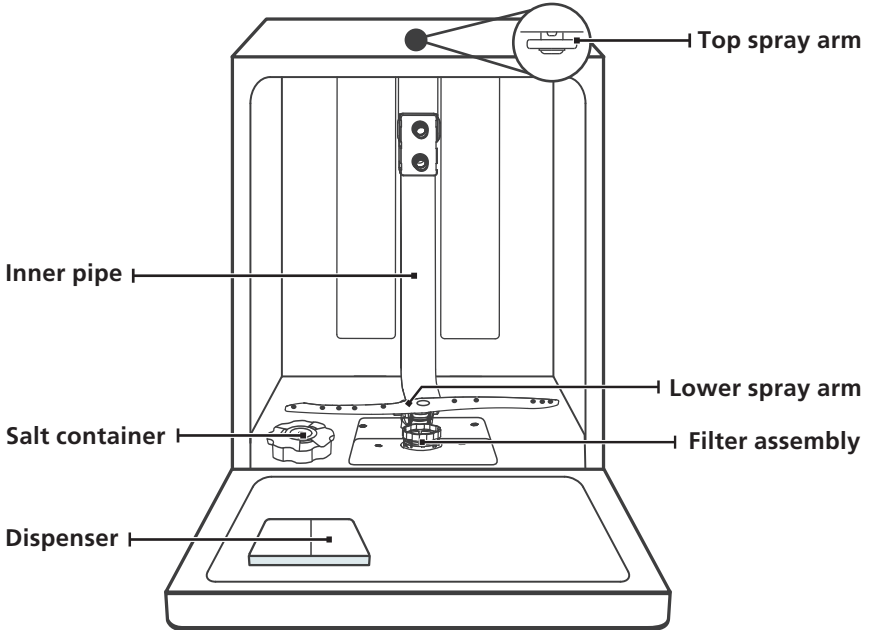

Cutlery rack

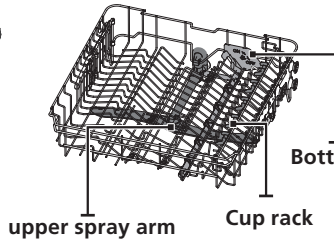

upper spray arm
Cup rack

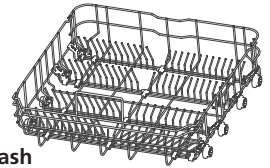

Bottle wash

Lower basket

💡 NOTE:

Pictures are only for reference, different models may be different.

USING YOUR DISHWASHER

Before using your dishwasher :

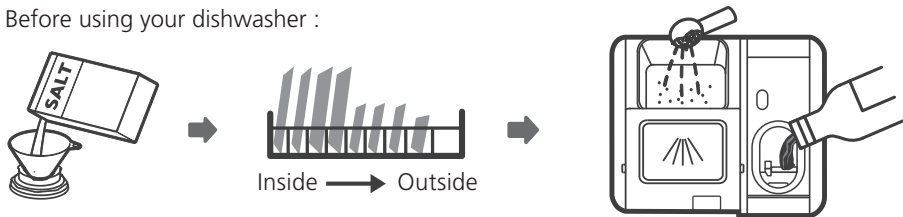

1. Set the water softener
2. Loading the salt Into the softener
3. Loading the basket
4. Fill the **detergent** dispenser



Please check the section 1 “Water Softener” of PART II : Special Version, if you need to set the water softener .

Loading The Salt Into The Softener

NOTE:

If your model does not have any water softener, you may skip this section. Always use salt intended for dishwasher use. The salt container is located beneath the lower basket and should be filled as explained in the following:

WARNING

- **Only use salt specifically designed for dishwashers use!**
Every other type of salt not specifically designed for dishwasher use, especially table salt, will damage the water softener. In case of damages caused by the use of unsuitable salt the manufacturer does not give any warranty nor is liable for any damages caused.
- **Only fill with salt before running a cycle.**
This will prevent any grains of salt or salty water, which may have been spilled, remaining on the bottom of the machine for any period of time, which may cause corrosion.

Please follow the steps below for adding dishwasher salt:

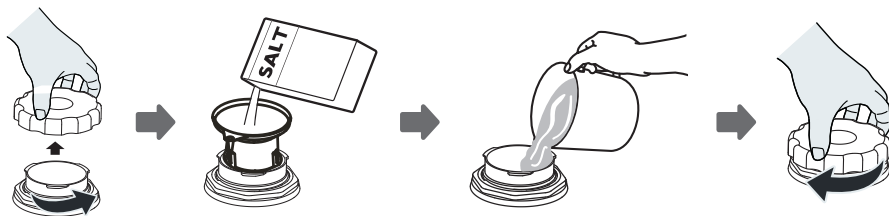

1. Remove the lower basket and unscrew the reservoir cap.
2. Place the end of the funnel (if supplied) into the hole and pour in about 1.5 kg of dishwasher salt.
3. Fill the salt container to its maximum limit with water, It is normal for a small amount of water to come out of the salt container.
4. After filling the container, screw back the cap tightly.
5. The salt warning light will **turn off** after the salt container has been filled with salt.
6. Immediately after filling the salt into the salt container, a washing program should be started (We suggest to use a short program). Otherwise the filter system, pump or other important parts of the machine may be damaged by salty water. This is out of warranty.

NOTE:

- The salt container must only be refilled when the salt warning light () in the control panel comes on. Depending on how well the salt dissolves, the salt warning light may still be on even though the salt container is filled. If there is no salt warning light in the control panel (for some **models**), you can estimate when to fill the salt into the softener by the cycles that the dishwasher has run.
- If salt has spilled, run a soak or quick program to remove it.

Basket Loading Tips

Adjusting the upper basket

Type 1:

The height of the upper basket can be easily adjusted to accommodate taller dishes in either the upper or lower basket.

To adjust the height of the upper rack, follow these steps:

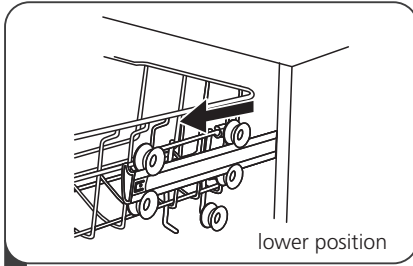

1 Pull out the upper basket.

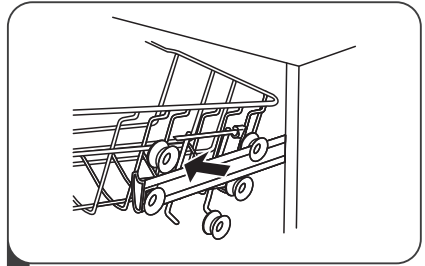

2 Remove the upper basket.

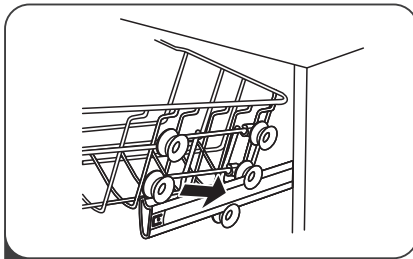

3 Re-attach the upper basket to upper or lower rollers.

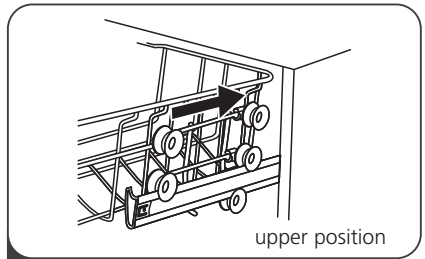

4 Push in the upper basket.

Type 2:

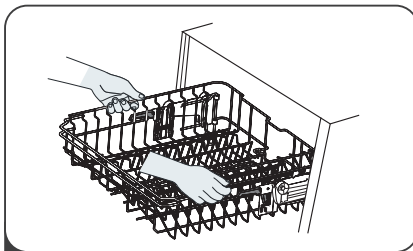

1 To raise the upper basket, just lift the upper basket at the center of each side until the basket locks into place in the upper position. It is not necessary to lift the adjuster handle.

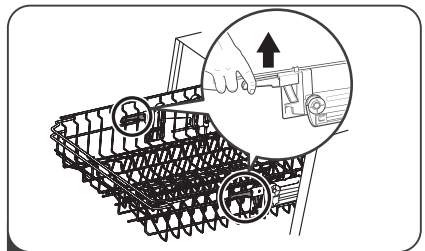

2 To lower the upper basket, lift the adjust handles on each side to release the basket and lower it to the lower position.

Folding back the cup shelves

To make room for taller items in the upper basket, raise the cup rack upwards. You can then lean the tall glasses against it.



Folding back the rack shelves

The spikes of the lower basket are used for holding plates and a platter. They can be lowered to make more room for large items.

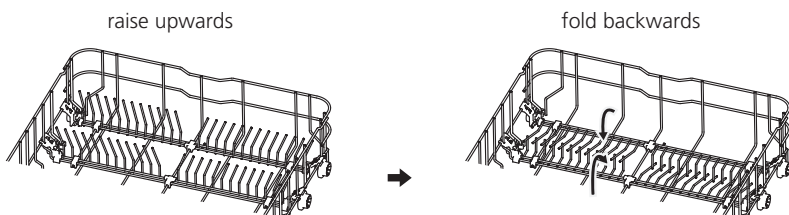

Bottle wash

Spin the handle to the position at on-state or off-state, to have the maximum washing performance. Do not leave the handle in the position between the two states.

Please fold down the cup holder, and place the bottle onto the nozzle, then the Spin the handle to the position at on-state to wash the bottles.

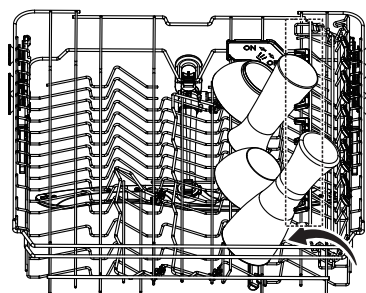
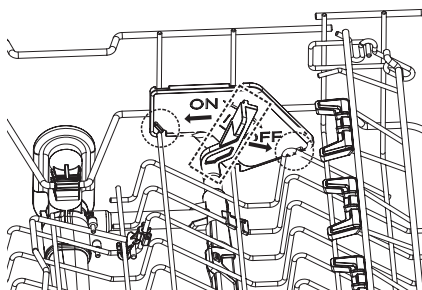

MAINTENANCE AND CLEANING

External Care

The door and the door seal

Clean the door seals regularly with a soft damp cloth to remove food deposits. When the dishwasher is being loaded, food and drink residues may drip onto the sides of the dishwasher door. These surfaces are outside the wash cabinet and are not accessed by water from the spray arms. Any deposits should be wiped off before the door is closed.

The control panel

If cleaning is required, the control panel should be wiped with a soft damp cloth only.

WARNING

- To avoid penetration of water into the door lock and electrical components, do not use a spray cleaner of any kind.
- Never use abrasive cleaners or scouring pads on the outer surfaces because they may scratch the finish. Some paper towels may also scratch or leave marks on the surface.

Internal Care

Filtering system

The filtering system in the base of the wash cabinet retains coarse debris from the washing cycle, including foreign objects such as tooth picks or shards. The collected coarse debris may cause the filters to clog. Check the condition of the filters regularly, carefully remove foreign objects and clean the parts of the filtering system if necessary with water. Follow the steps below to clean the filter.

NOTE:

Pictures are only for reference, different models of the filtering system and spray arms may be different.

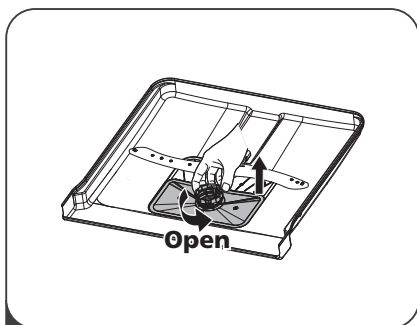

- 1 Hold the coarse filter and rotate it anticlockwise to unlock the filter. Lift the filter upwards and out of the dishwasher.

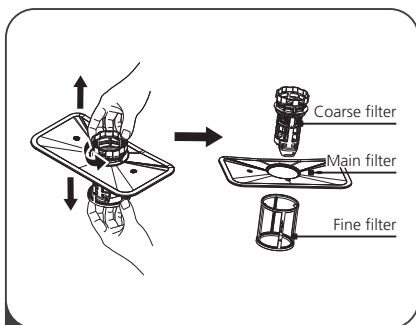

- 2 The fine filter can be pulled off the bottom of the filter assembly. The coarse filter can be detached from the main filter by gently squeezing the tabs at the top and pulling it away.

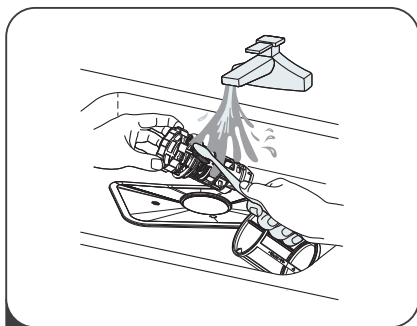

- 3 Larger food remnants can be cleaned by rinsing the filter under running water. For a more thorough clean, use a soft cleaning brush.

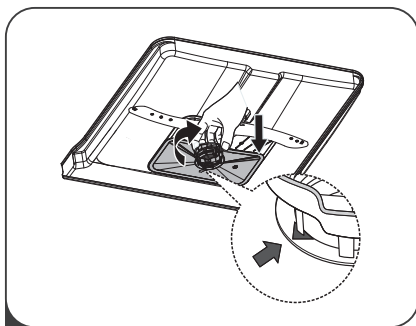

- 4 Reassemble the filters in the reverse order of the disassembly, replace the filter insert, and rotate clockwise to the close arrow.

⚠ WARNING

- Do not over tighten the filters. Put the filters back in sequence securely, otherwise coarse debris could get into the system and cause a blockage.
- Never use the dishwasher without filters in place. Improper replacement of the filter may reduce the performance level of the appliance and damage dishes and utensils.

Spray arms

It is necessary to clean the spray arms regularly for hard water chemicals will clog the spray arm jets and bearings.

To clean the spray arms, follow the instructions below:

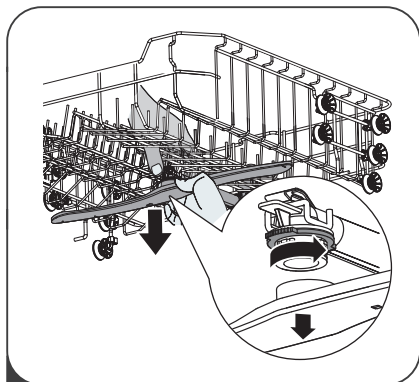

- 1** To remove the upper spray arm, hold the nut in the center still and rotate the spray arm counterclockwise to remove it.

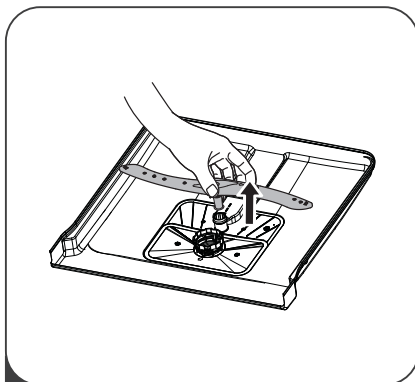

- 2** To remove the lower spray arm, pull out the spray arm upward.

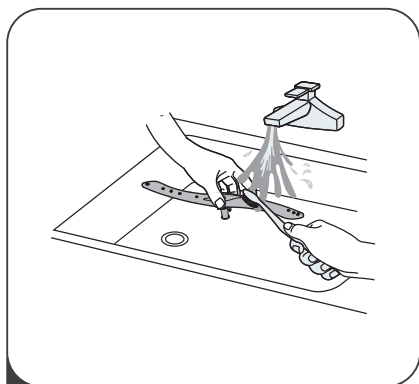

- 3** Wash the arms in soapy and warm water and use a soft brush to clean the jets.

Caring For The Dishwasher

Frost precaution

Please take frost protection measures on the dishwasher in winter. Every time after washing cycles, please operate as follows:

1. Cut off the electrical power to the dishwasher at the supply source.
2. Turn off the water supply and disconnect the water inlet pipe from the water valve.
3. Drain the water from the inlet pipe and water valve. (Use a pan to gather the water)
4. Reconnect the water inlet pipe to the water valve.
5. Remove the filter at the bottom of the tub and use a sponge to soak up water in the sump.

After every wash

After every wash, turn off the water supply to the appliance and leave the door slightly open **for a while** so that moisture and odors are not trapped inside.

Remove the plug

Before cleaning or performing maintenance, always remove the plug from the socket.

No solvents or abrasive cleaning

To clean the exterior and rubber parts of the dishwasher, do not use solvents or abrasive cleaning products. Only use a cloth with warm soapy water.

To remove spots or stains from the surface of the interior, use a cloth dampened with water and a little vinegar, or a cleaning product made specifically for dishwashers.

When not in use for a long time

It is recommended that you run a wash cycle with the dishwasher empty and then remove the plug from the socket, turn off the water supply and leave the door of the appliance slightly open. This will help the door seals to last longer and prevent odors from forming within the appliance.

Moving the appliance

If the appliance must be moved, try to keep it in the vertical position. If absolutely necessary, it can be positioned on its back.

Seals

One of the factors that cause odours to form in the dishwasher is food that remains trapped in the seals. Periodic cleaning with a damp sponge will prevent this from occurring.

INSTALLATION INSTRUCTION

⚠ WARNING



Electrical Shock Hazard

Disconnect electrical power before installing dishwasher.

Failure to do so could result in death or electrical shock.

⚠ Attention

The installation of the pipes and electrical equipments should be done by professionals.

About Power Connection

⚠ WARNING

For personal safety:

- Do not use an extension cord or an adapter plug with this appliance.
- Do not, under any circumstances, cut or remove the earthing connection from the power cord.

Electrical requirements

Please look at the rating label to know the rating voltage and connect the dishwasher to the appropriate power supply. Use the required fuse 10A/13A/16A, time delay fuse or circuit breaker recommended and provide separate circuit serving only this appliance.

Electrical connection

Ensure the voltage and frequency of the power being corresponds to those on the rating plate. Only insert the plug into an electrical socket which is earthed properly. If the electrical socket to which the appliance must be connected is not appropriate for the plug, replace the socket, rather than using a adaptors or the like as they could cause overheating and burns.

⚠ Ensure that proper earthing exists before use

Water Supply And Drain

Cold water connection

Connect the cold water supply hose to a threaded 3/4(inch) connector and make sure that it is fastened tightly in place.

If the water pipes are new or have not been used for an extended period of time, let the water run to make sure that the water is clear. This precaution is needed to avoid the risk of the water inlet to be blocked and damage the appliance.

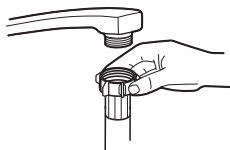

ordinary supply hose



safety supply hose

NOTE:

When connecting to drinking water make sure that you connect the appliance using a safety device against drinking water contamination through backflow (according to DIN EN 1717). We recommend that installation, including water supply and electrical connections, and repairs are carried out by a qualified technician.

About the safety supply hose

The safety supply hose consists of the double walls. The system guarantees its intervention by blocking the flow of water in case of the supply hose breaking and when the air space between the supply hose itself and the outer corrugated hose is full of water.

⚠ WARNING

A hose that attaches to a tap can burst if it is installed on the same water line as the dishwasher. If your sink has one, it is recommended that the hose be disconnected and the hole plugged.

How to connect the safety supply hose

1. Pull the safety supply hoses out from storage compartment located at rear of dishwasher.
2. Tighten the screws of the safety supply hose to the faucet with thread 3/4inch.
3. Turn the water fully on before starting the dishwasher.

How to disconnect the safety supply hose

1. Turn off the water.
2. Unscrew the safety supply hose from the faucet.

Connection Of Drain Hoses

Insert the drain hose into a drain pipe with a minimum diameter of 4 cm, or let it run into the sink, making sure to avoid bending or crimping it. The height of drain pipe must be less than 1000 mm. The free end of the hose must not be immersed in water to avoid the back flow of it.

⚠ Please securely fix the drain hose in either position A or position B

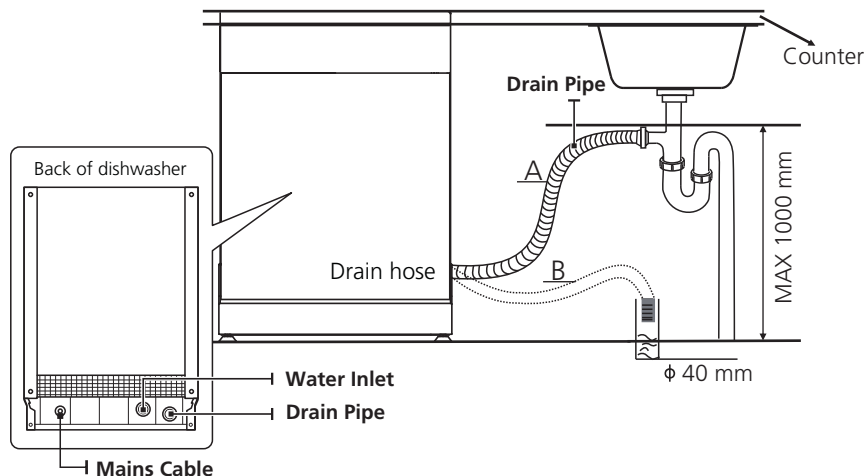

How to drain excess water from hoses

If the connection to the drain pipe is positioned higher than 1000 mm, excess water may remain in the drain hose. It will be necessary to drain excess water from the hose into a bowl or suitable container that is held outside and lower than the sink.

Water outlet

Connect the water drain hose. The drain hose must be correctly fitted to avoid water leaks. Ensure that the water drain hose is not kinked or squashed.

Extension hose

If you need a drain hose extension, make sure to use a similar drain hose. It must not be longer than 4 meters, otherwise the cleaning effect of the dishwasher could be reduced.

Syphon connection

The waste connection must be at a height less than 1000 mm (maximum) from the bottom of the dishwasher.

Positioning The Appliance

Position the appliance in the desired location. The back should rest against the wall behind it, and the sides, along the adjacent cabinets or walls. The dishwasher is equipped with water supply and drain hoses that can be positioned either to the right or the left sides to facilitate proper installation.

Levelling the appliance

Once the appliance is positioned for levelling, the height of the dishwasher may be altered via adjustment of the screwing level of the feet. In any case, the appliance should not be inclined more than 2°.

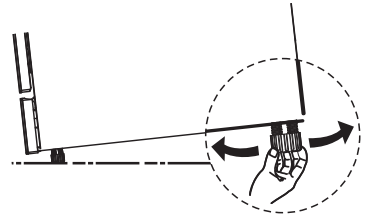

Built-In Installation (for the integrated model)

Step 1. Selecting the best location for the dishwasher

The installation position of the dishwasher should be near the existing inlet and drain hose and power socket.

Illustrations of cabinet dimensions and installation position of the dishwasher.

1. Less than 5 mm between the top of dishwasher and cabinet and the outer door aligned to cabinet.

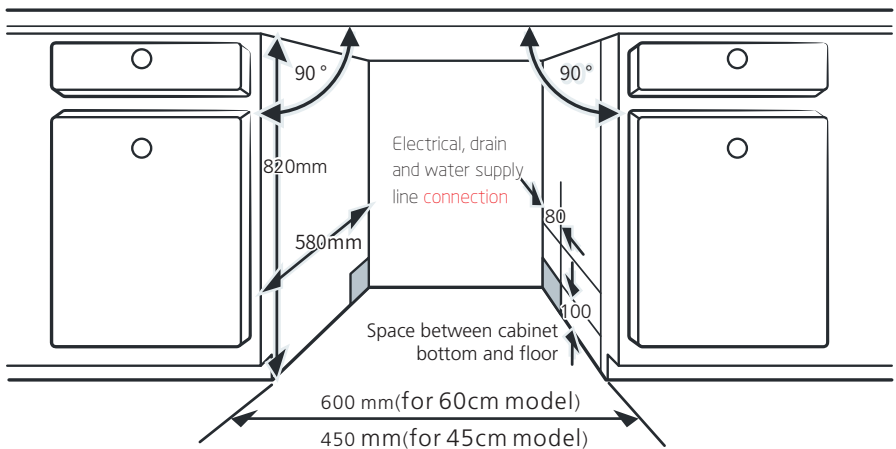

2. If dishwasher is **installed** at the corner of the cabinet, there should be some space when the door is opened.

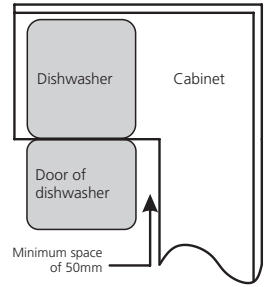

NOTE:

Depending on where your electrical outlet is, you may need to cut a hole in the opposite cabinet side.

Step 2. Aesthetic panel's dimensions and installation



Follow the specific installation instruction for attaching the aesthetical door panel.

Install the hook on the aesthetic panel(see figure 4A) and put the hook into the slot of the outer door of dishwasher(see figure 4B). After positioning the panel, it should be fixed by two screws from two lower installation holes(see figure 4C). After tightening the screws, two rubber plugs should be plugged into the **holes** to avoid finger clamping.

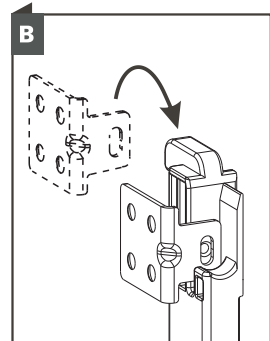
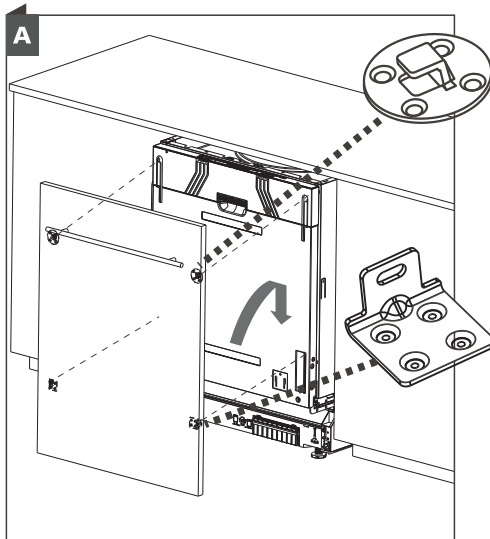

C

After tightening the screws, two rubber plugs should be plugged into the **holes** to avoid finger clamping.

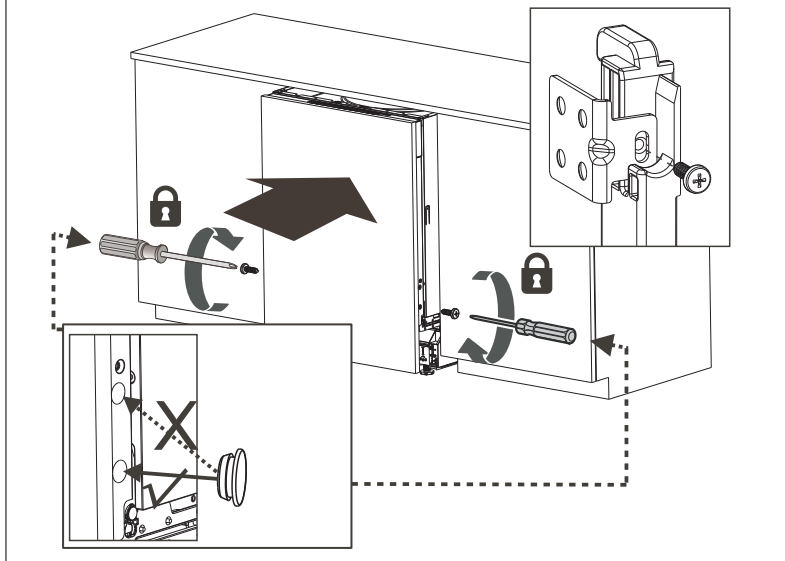

 **NOTE:**

In any cases, please **DO NOT** insert the fingers into the side holes on dishwasher door, since that may cause serious hazard.
Please **DO NOT** leave the installation hole open after installation to avoid any potential hurt to children.

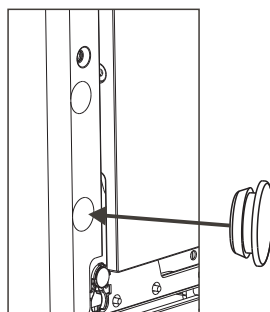
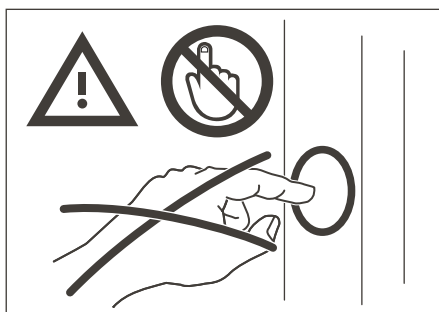

Step 3. Dishwasher installation steps



Please refer to the **specific** installation steps in the installation drawings.

1. Affix the condensation strip under the work surface of cabinet. Please ensure the condensation strip is flush with edge of work surface. (Step 2)
2. Connect the inlet hose to the cold water supply.
3. Connect the drain hose.
4. Connect the power cord.
5. Place the dishwasher into **the cabinet**.
6. Level the dishwasher. The rear foot can be adjusted from the front of the dishwasher by turning the Philips screw in the middle of the base of dishwasher use a Philips screw **driver**. To adjust the front feet, use a flat screw driver and turn the front feet until the dishwasher is level. (Step 5 to Step 6)
7. Install the furniture door to the outer door of the dishwasher. (Step 7 to Step 9)
8. The dishwasher must be secured in place. There are two ways to do this:
 - A. Normal work surface: Put the installation hook into the slot of the side plane and secure it to the work surface with **the screws**.
 - B. Marble or granite work top: Fix the side with **screws**.

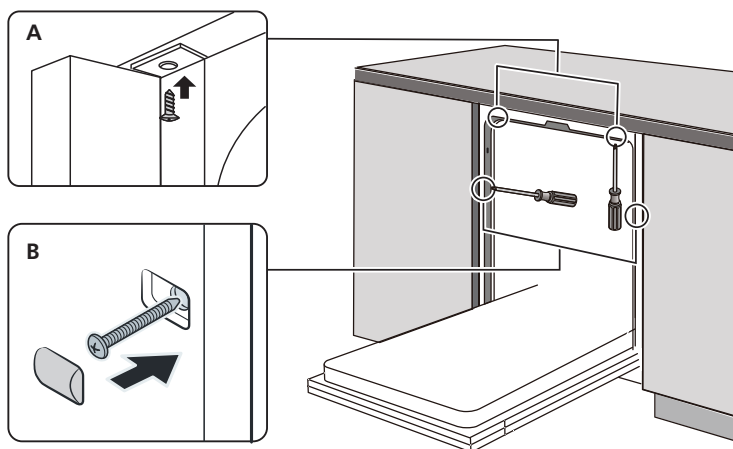

Step 4. Levelling the dishwasher

Dishwasher must be level for proper dish rack operation and wash performance.

1. Place a spirit level on door and rack track inside the tub as shown to check that the dishwasher is level.
2. Level the dishwasher by adjusting the three levelling feet individually.
3. When level the dishwasher, please pay attention not to let the dishwasher tip over.

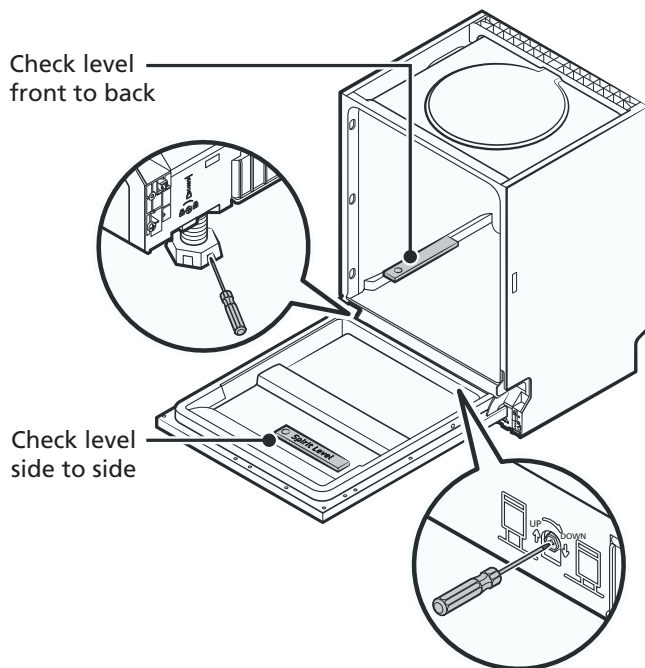

NOTE:

The maximum adjustment height of the feet is 50 mm.

TROUBLESHOOTING TIPS

Before Calling For Service

Reviewing the charts on the following pages may save you from calling for service.

Problem	Possible Causes	What To Do
Dishwasher doesn't start	Fuse blown, or the circuit break tripped.	Replace fuse or reset circuit breaker. Remove any other appliances sharing the same circuit with the dishwasher.
	Power supply is not turned on.	Make sure the dishwasher is turned on and the door is closed securely. Make sure the power cord is properly plugged into the wall socket.
	Water pressure is low	Check that the water supply is connected properly and the water is turned on.
	Door of dishwasher not properly closed.	Make sure to close the door properly and latch it.
Water not pumped form dishwasher	Twisted or trapped drain hose.	Check the drain hose.
	Filter clogged.	Check the filter system .
	Kitchen sink clogged.	Check the kitchen sink to make sure it is draining well. If the problem is the kitchen sink that is not draining , you may need a plumber rather than a serviceman for dishwashers.
Foam in the tub	Wrong detergent.	Use only the special dishwasher detergent to avoid suds. If this occurs, open the dishwasher and let suds evaporate. Add 1 liter of cold water to the bottom of the dishwasher. Close the dishwasher door, then select any cycle. Initially, the dishwasher will drain out the water. Open the door after draining stage is complete and check if the suds have disappeared. Repeat if necessary.

Problem	Possible Causes	What To Do
	Spilled rinse aid .	Always wipe up rinse aid spills immediately.
Stained tub interior	Detergent with colourant may have been used.	Make sure that the detergent has no colourant.
White film on inside surface	Hard water minerals.	To clean the interior, use the damp soft cloth with dishwasher detergent and wear rubber gloves. Never use any other cleaner than dishwasher detergent otherwise, it may cause foaming or suds.
There are rust stains on cutlery	The affected items are not corrosion resistant.	Avoid washing items that are not corrosion resistant in the dishwasher.
	A program was not run after dishwasher salt was added. Traces of salt have gotten into the wash cycle.	Always run a wash program without any crockery after adding salt. Do not select the Turbo function (if present), after adding dishwasher salt.
	The lid of the softer is loose.	Check the softener lid is secure.
Knocking noise in the dishwasher	A spray arm is knocking against an item in a basket	Interrupt the program and rearrange the items which are obstructing the spray arm.
Rattling noise in the dishwasher	Items of crockery are loose in the dishwasher.	Interrupt the program and rearrange the items of crockery.
Knocking noise in the water pipes	This may be caused by on-site installation or the cross-section of the piping.	This has no influence on the dishwasher function. If in doubt, contact a qualified plumber.
The dishes are not clean	The dishes were not loaded correctly.	See PART II "Preparing And Loading Dishes".
	The program was not powerful enough.	Select a more intensive program.

Problem	Possible Causes	What To Do
The dishes are not clean.	Not enough detergent was dispensed.	Use more detergent, or change your detergent.
	Items are blocking the movement of the spray arms.	Rearrange the items so that the spray can rotate freely.
	The filter combination is not clean or is not correctly fitted in the base of wash cabinet. This may cause the spray arm jets to get blocked.	Clean and/or fit the filter correctly. Clean the spray arm jets.
Cloudiness on glassware.	Combination of soft water and too much detergent.	Use less detergent if you have soft water and select a shorter cycle to wash the glassware and to get them clean.
White spots appear on dishes and glasses.	Hard water area can cause limescale deposits.	Check water softener settings or fill status of salt container.
Black or grey marks on dishes	Aluminium utensils have rubbed against dishes	Use a mild abrasive cleaner to eliminate those marks.
Detergent left in dispenser	Dishes block detergent dispenser	Re-loading the dishes properly.
The dishes aren't drying	Improper loading	Use gloves if detergent residue can be found on dishes to avoid skin irritations.
	Dishes are removed too soon	Do not empty your dishwasher immediately after washing. Open the door slightly so that the steam can come out. Take out the dishes until the inside temperature is safe to touch. Unload the lower basket first to prevent the dropping water from the upper basket.

Problem	Possible Causes	What To Do
The dishes aren't drying	Wrong program has been selected.	With a short program, the washing temperature is lower, decreasing cleaning performance. Choose a program with a long washing time.
	Use of cutlery with a low-quality coating.	Water drainage is more difficult with these items. Cutlery or dishes of this type are not suitable for washing in the dishwasher.

WARNING

Self-repair or non-professional repair may cause serious risks to the safety of the user of the appliance and impact warranty.

Availability Of Spare Parts

- Seven years after placing the last unit of the model on the market:**
 Motor, circulation and drain pump, heaters and heating elements, including heat pumps (separately or bundled), piping and related equipment including all hoses, valves, filters and aqua stops, structural and interior parts related to door assemblies (separately or bundled), printed circuit boards, electronic displays, pressure switches, thermostats and sensors, software and firmware including reset software.
- Ten years after placing the last unit of the model on the market:**
 Door hinge and seals, other seals, spray arms, drain filters, interior racks and plastic peripherals such as baskets and lids.

LOADING THE BASKETS ACCORDING TO EN60436:

Loading the dishwasher to its full capacity will contribute to energy and water savings.

1.Upper basket:

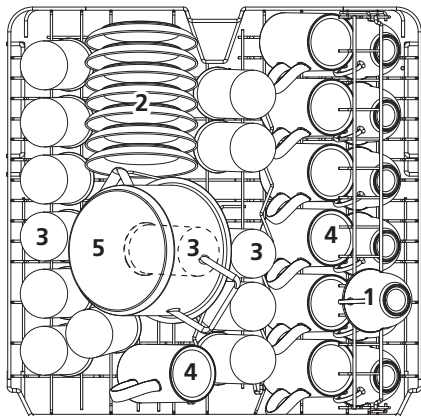

Number	Item
1	Cups
2	Saucers
3	Glasses
4	Mugs
5	Small pot

2.Lower basket:

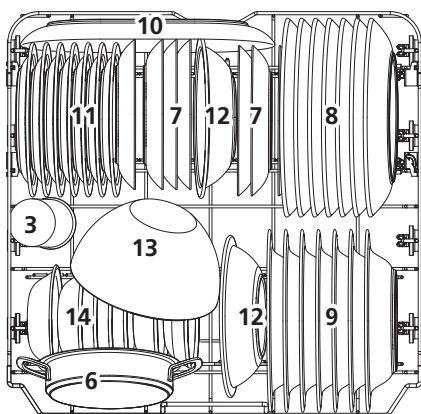

Number	Item
6	Oven pot
7	Dessert plates
8	Dinner plates
9	Soup plates
10	Oval platter
11	Melamine dessert plates
12	Melamine bowls
13	Glass bowl
14	Dessert bowls

3.Cutlery rack:

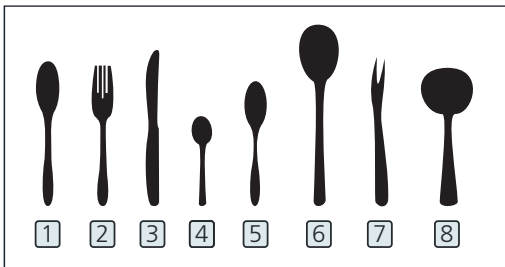
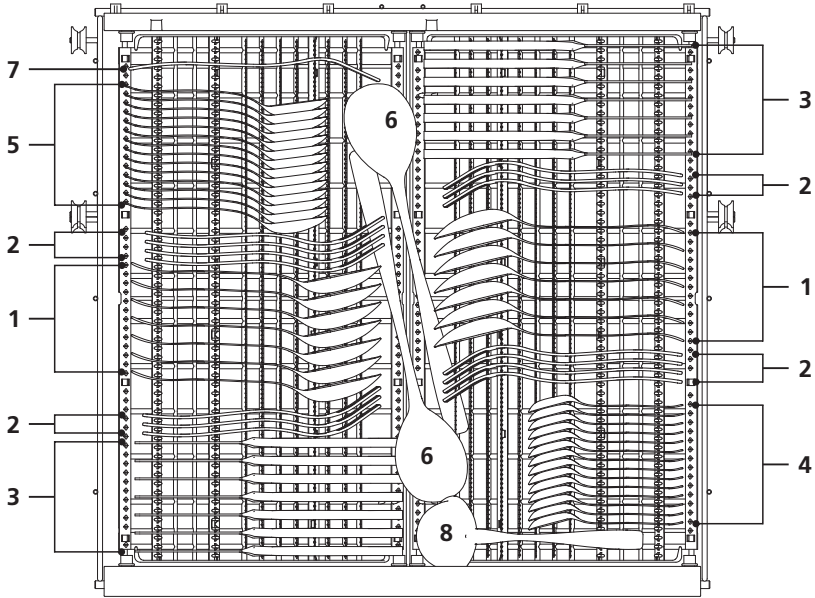

Number	Item
1	Soup spoons
2	Forks
3	Knives
4	Tea spoons
5	Dessert spoons
6	Serving spoons
7	Serving fork
8	Gravy ladle

Information for comparability tests in accordance with EN60436
 Capacity: 14 place settings
 Position of the upper basket: lower position
 Program: ECO
 Rinse aid setting: Max
 Softener setting: H3

Cutlery Rack Used Tips

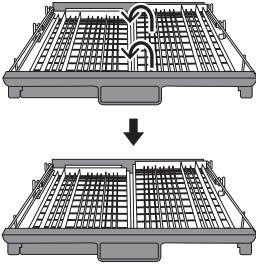

Lift the right basket up, both left and right baskets are flat.

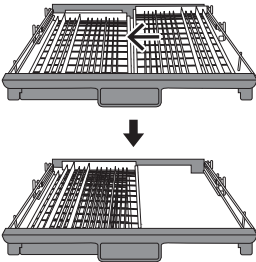

Move the right basket from right to left, two basket are overlapping.

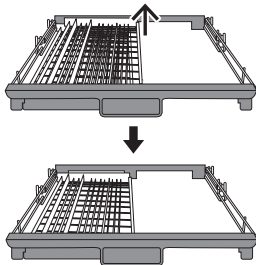

Remove the right basket from the tray, only has the left basket.

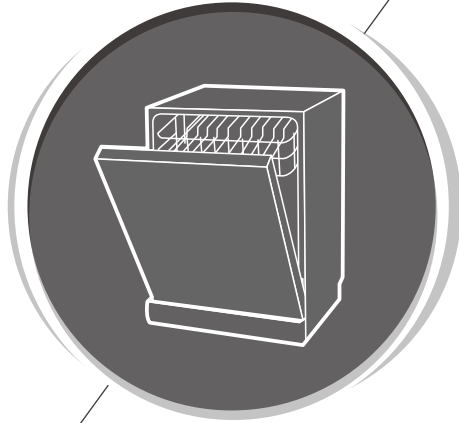

Dishwasher

Instruction Manual

PART II: Special Instructions
G6564.0V

Küppersbusch

Please read this manual carefully
before using the dishwasher and
Keep this manual for future reference.

CONTENTS

01	4	USING YOUR DISHWASHER
	4	Control Panel
	7	Water Softener
	8	Preparing And Loading Dishes
	11	Function Of The Rinse Aid And Detergent
02	12	Filling The Rinse Aid Reservoir
	13	Filling The Detergent Dispenser
	14	PROGRAM SELECTION
	14	Wash Cycle Table
	16	Saving Energy
	16	Starting A Program
03	16	Changing The Program Mid-cycle
	17	Forget To Add A Dish?
	17	Auto Open
04	18	ERROR CODES
	19	TECHNICAL INFORMATION

NOTE:

- If you cannot solve the problems by yourself, please ask for help from a professional technician.
- The manufacturer, following a policy of constant development and updating of the product, may make modifications without giving prior notice.
- If lost or out-of-date, you can receive a new user manual from the manufacturer or responsible vendor.

QUICK USER GUIDE

Please read the corresponding content on the instruction manual for detailed operating method.

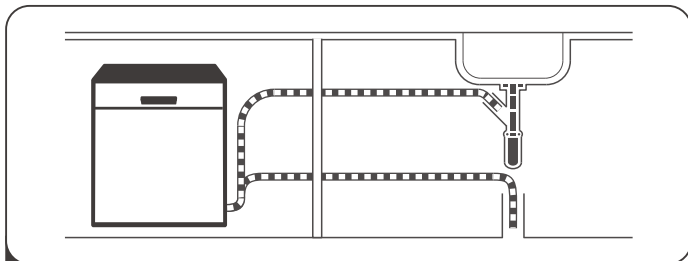

- 1 Install the dishwasher
(Please check the section 5 "INSTALLATION INSTRUCTION" of PART I : Generic Version.)



- 2 Remove larger residue from dishes.
Avoid pre-rinsing.

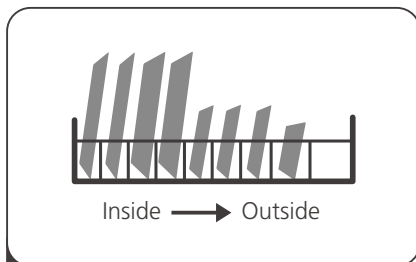

- 3 Load the baskets.

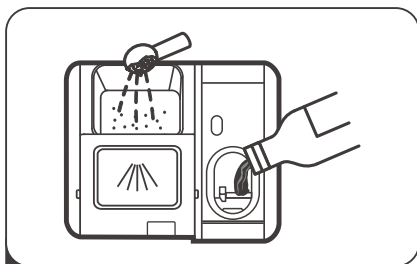

- 4 Fill the dispenser with detergent and rinse aid.



- 5 Select a suitable program and start the dishwasher.



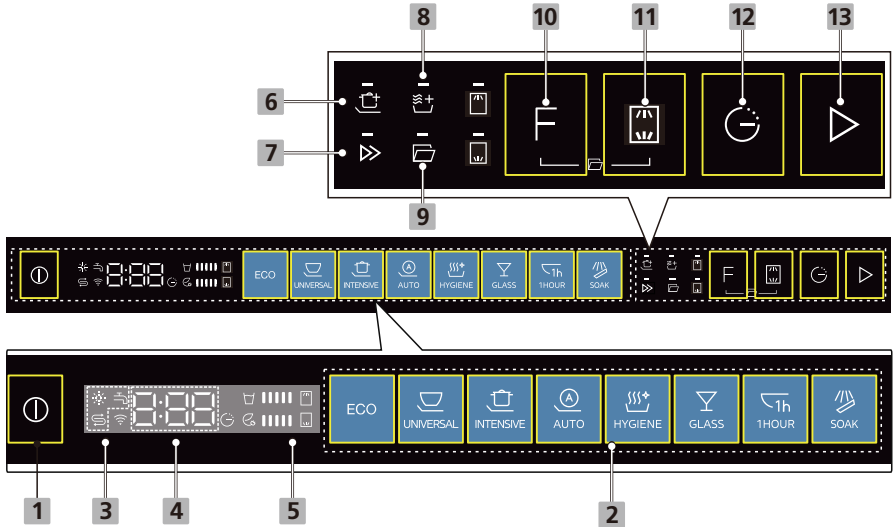

USING YOUR DISHWASHER

Control Panel









Operation (Button)











<p>1 Power</p>	<p>Press this button to turn on your dishwasher, the screen lights up.</p>
<p>2 Program</p>	<p>ECO ECO This is standard program, it is suitable to clean normally soiled tableware and it is the most efficient program in terms of its combined energy and water consumption for that type of tableware.</p> <p>UNIVERSAL Universal For normally soiled loads, such as pots, plates, glasses and lightly soiled pans.</p> <p>INTENSIVE Intensive Heavily soiled items include pots and pans. With dried on food.</p>

<p>2 Program</p>	<p> Auto Auto sensing wash, lightly, normally or heavily soiled crockery, with or without dried-on food.</p> <p> Hygiene This program is suitable for all types of crockery and soil levels. It provides the highest wash temperature for the sanitization of dishes.</p> <p> Glass For lightly soiled crockery and glass.</p> <p> 58 min For normally soiled loads that need a quick wash and dry.</p> <p> Soak To rinse dishes that you plan to wash later that day.</p>
-------------------------	--

Display

<p>3 Warning Indicator</p>	<p> Rinse Aid When the "☼" indicator is lit, it means the dishwasher is low on rinse aid and requires a refill.</p> <p> Salt When the "⌘" indicator is lit, it means the dishwasher is low on dishwasher salt and needs to be refilled.</p> <p> Water Faucet If the "⌘" indicator is lit, it means the water faucet closed.</p>
<p>4 Screen</p>	<p> Display of the remaining program time, delay time, error codes, etc.</p>
<p>5 Consumption Indicator</p>	<p> Water consumption level The consumption indicator shows the water consumption level of a selected program. The more bars are displayed, the higher the water consumption is.</p> <p> Energy consumption level The consumption indicator shows the energy consumption level of a selected program. The more bars are displayed, the higher the energy consumption is.</p>

Function

6 Power wash	 To wash very dirty, hard to clean dishes. It can not be used with Auto & Soak .
7 Turbo Speed+	 With this option the running time will be reduced by 15%-50%, according to increased temperature and motor rotate speed. It can not be used with Auto & Soak .
8 Extra Drying	 With this option the drying effect will be improved by increased temperature in the last rinse and longer drying time. It can not be used with Auto & Soak .
9 Auto Open	 The dishwasher door automatically opens at the end of the program to improve the drying result. It can not be used with Soak . Press and hold the delay "F" and "Alt" buttons for 3 seconds to open or cancel this function. When the icon lights up, the function of Auto open is selected.
10 Function	 Press the button to select a function, corresponding indicator will be lit.
11 Alt	 Press the button to select a wash for either only upper or lower basket only or both. The response indicators ( ) will be lit.
12 Delay	 Press the button to delay the start time of a program for up to 24 hours in one-hour increments. When selected the response indicator () will be lit.
13 Start	 After completing program and function selection or delay time setting, press this button and then close the door, the dishwasher will start.

Function of Floor Indicator Lamp

NOTE:

Indicator lamp function

The Indicator lamp will be lit up during the washing program, then blink for 5 minutes and extinguished on the end of the program.

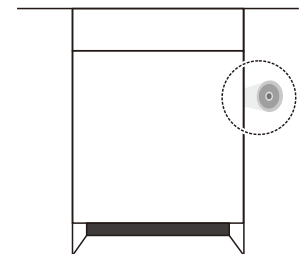

Water Softener

The water softener must be set manually, using the water hardness dial.

The water softener is designed to remove minerals and salts from the water, which would have a detrimental or adverse effect on the operation of the appliance.

The more minerals there are, the harder your water is. If hard water is used in the dishwasher, deposits will form on the dishes and utensils.

The softener should be adjusted according to the hardness of the water in your area. Your local water authority can advise you on the hardness of the water in your area.

Adjusting salt consumption

The dishwasher is designed to allow for adjustment in the amount of salt consumed based on the hardness of the water used. This is intended to optimise and customise the level of salt consumption.

To adjust the water softener setting follow the steps below:

1. **Open** the door and switch on the appliance.
2. Within 60 seconds after the appliance was switched on press the **Soak** button for more than 5 seconds to enter the water softener setting mode.
3. Press the **Soak** button again to select the proper setting according to your local environment, the setting will change in the following sequence:
H3->H4->H5->H6->H1->H2->H3;
4. Without operation in 5 seconds or press the Power button to complete the setup and exit the setting mode.

WATER HARDNESS				Water softner level	Regeneration occurs every X program sequence 1)	Salt consumption (gram/cycle)
German °dH	French °fH	British °Clarke	mmol/l			
0 - 5	0 - 9	0 - 6	0 - 0.94	H1	No regeneration	0
6 - 11	10 - 20	7 - 14	1.0 - 2.0	H2	10	9
12 - 17	21 - 30	15 - 21	2.1 - 3.0	H3	5	12
18 - 22	31 - 40	22 - 28	3.1 - 4.0	H4	3	20
23 - 34	41 - 60	29 - 42	4.1 - 6.0	H5	2	30
35 - 55	61 - 98	43 - 69	6.1 - 9.8	H6	1	60

1°dH=1.25 °Clarke=1.78 °fH=0.178mmol/l

The factory setting: **H3**

- 1) Every cycle with a regeneration operation consumes additional **3.0** litres of water, the energy consumption increases by **0.02** kWh and the program extents by **4** minutes.



Please check the section 3 “Loading The Salt Into The Softener” of PART I : Generic Version, If your dishwasher lacks salt.



NOTE:

If your model does not have any water softener, you may skip this section.

Water Softener

The hardness of the water varies from place to place. If hard water is used in the dishwasher, deposits will form on the dishes and utensils.

The appliance is equipped with a special softener that uses a salt container specifically designed to eliminate lime and minerals from the water.

Preparing And Loading Dishes

- Consider buying utensils which are identified as dishwasher-proof.
- For particular items, select a program with the lowest possible temperature.
- To prevent damage, do not take glass and cutlery out of the dishwasher immediately after the program has ended.

For washing the following cutlery/dishes

Are not suitable

- Cutlery with wooden, horn china or mother-of-pearl handles
- Plastic items that are not heat resistant
- Older cutlery with glued parts that are not temperature resistant
- Bonded cutlery items or dishes
- Pewter or cooper items
- Crystal glass
- Steel items subject to rusting
- Wooden platters
- Items made from synthetic fibres

Are of limited suitability

- Some types of glasses can become dull after a large number of washes
- Silver and aluminum parts have a tendency to discolor during washing
- Glazed patterns may fade if machine washed frequently

Recommendations for loading the dishwasher

Scrape off any large amounts of leftover food. Soften remnants of burnt food in pans. It is not necessary to rinse the dishes under running water.

For best performance of the dishwasher, follow these loading guidelines.

(Features and appearance of baskets and cutlery baskets may vary from your model.)

Place objects in the dishwasher in following way:

- Items such as cups, glasses, pots/pans, etc. are faced downwards.
- Curved items, or ones with recesses, should be loaded aslant so that water can run off.
- All utensils are stacked securely and can not tip over.
- All utensils are placed in the way that the spray arms can rotate freely during washing.
- Load hollow items such as cups, glasses, pans etc. With the opening facing downwards so that water cannot collect in the container or a deep base.
- Dishes and items of cutlery must not lie inside one another, or cover each other.
- To avoid damage, glasses should not touch one another.
- The upper basket is designed to hold more delicate and lighter dishware such as glasses, coffee and tea cups.
- Long bladed knives stored in an upright position are a potential hazard!
- Long and / or sharp items of cutlery such as carving knives must be positioned horizontally in the upper basket.
- Please do not overload your dishwasher. This is important for good results and for reasonable consumption of energy.

NOTE:

Very small items should not be washed in the dishwasher as they could easily fall out of the basket.

Removing the dishes

To prevent water dripping from the upper basket into the lower basket, we recommend that you empty the lower basket first, followed by the upper basket.

WARNING



Items will be hot! To prevent damage, do not take glass and cutlery out of the dishwasher for around 15 minutes after the program has ended.

Loading the upper basket

The upper basket is designed to hold more delicate and lighter dishware such as glasses, coffee and tea cups and saucers, as well as plates, small bowls and shallow pans (as long as they are not too dirty). Position the dishes and cookware so that they will not get moved by the spray of water.



Loading the lower basket

We suggest that you place large and difficult to clean items into the lower basket: such as pots, pans, lids, serving dishes and bowls, as shown in the figure below. It is preferable to place serving dishes and lids on the side of the racks in order to avoid blocking the rotation of the top spray arm.

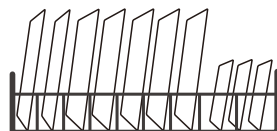

The maximum diameter advised for plates in front of the detergent dispenser is of 19 cm, this not to hamper the opening of it.

Loading the cutlery basket

Cutlery should be placed in the cutlery basket separate from each other in the appropriate positions. Avoid nesting of the cutlery to prevent insufficient cleaning performance.

⚠ WARNING



Do not let any item extend through the bottom.

Always load sharp utensils with the sharp point down!



For the best washing effect, please load the baskets refer to standard loading options on last section of **PART I : Generic Version**

Function Of The Rinse Aid And Detergent

The rinse aid is released during the final rinse to prevent water from forming droplets on your dishes, which can leave spots and streaks. It also improves drying by allowing water to roll off the dishes. Your dishwasher is designed to use liquid rinse aids.

⚠ WARNING

Only use branded rinse aid for dishwasher. Never fill the rinse aid dispenser with any other substances (e.g. Dishwasher cleaning agent, liquid detergent). This would damage the appliance.

When to refill the rinse aid

The regularity of the dispenser needing to be refilled depends on how often dishes are washed and the rinse aid setting used.

- The Low Rinse Aid indicator () will be lit when more rinse aid is needed.
- Do not overfill the rinse aid dispenser.

Function of detergent

The chemical ingredients that compose the detergent are necessary to remove, crush and dispense all dirt out of the dishwasher. Most of the commercial quality detergents are suitable for this purpose.

⚠ WARNING

- Proper Use of Detergent

Use only detergent specifically made for dishwashers use. Keep your detergent fresh and dry.

Do not fill detergent into the dispenser until you are ready to start the dishwasher.



Dishwasher detergent is corrosive! Keep dishwasher detergent out of the reach of children.

Filling The Rinse Aid Reservoir

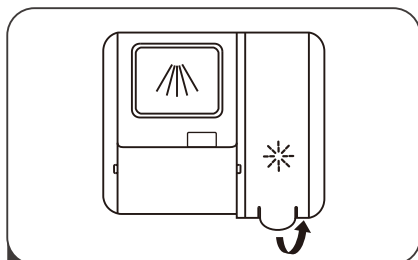

- 1 Remove the rinse reservoir cap by lifting up the handle .

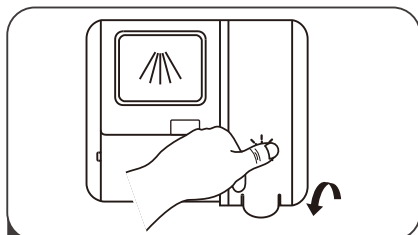

- 3 Close the cap after all.

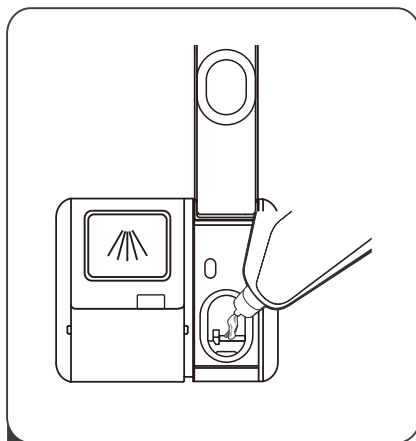

- 2 Pour the rinse aid into the dispenser, being careful not to overfill.

Adjusting the rinse aid setting

The amount of rinse aid dispensed in the final rinse can be adjusted as follows:

1. **Open** the door and switch on the appliance.
2. Within 60 seconds after the appliance was switched on press the **Soak** button for more than 5 seconds and then press the **Delay** button to enter the rinse aid setting mode. The rinse aid indicator will start blinking.
3. Press the **Soak** button again to select the setting according to your needs. The setting will change in the following sequence: **d3->d4->d5->d1->d2->d3**. The higher the number, the more rinse aid the dishwasher will use. **The factory setting is d3.**
4. When the desired setting is reached wait 5 seconds or press the Power button to complete the setup and exit the setting mode.

Filling The Detergent Dispenser

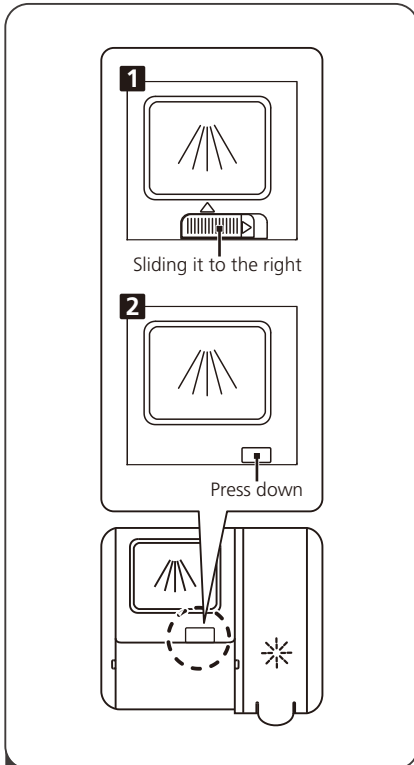

1 Please choose an open way according to the actual situation.

1. Open the cap by sliding the release catch.
2. Open the cap by pressing down the release catch.

NOTE:

- Be aware that depending on the soiling of water, setting may be different.
- Please observe the manufacturer's recommendations on the detergent packaging.

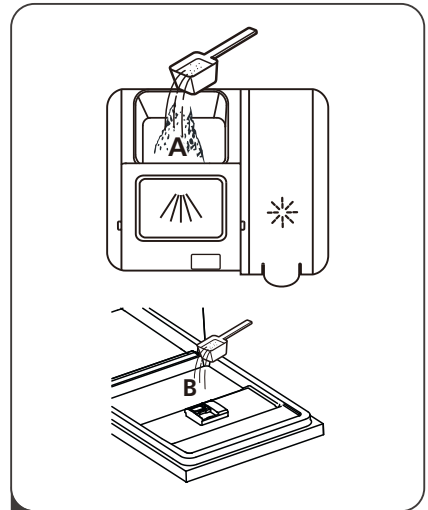

- 2** Add detergent into the larger cavity (A) for the main wash cycle . For better cleaning result, especially if you have very dirt items, pour a small amount of detergent onto the door. The additional detergent will activate during the pre-wash phase.

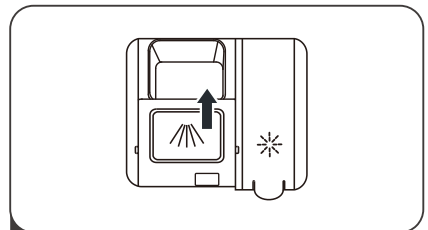







- 3** Close the flap by sliding it to the front and then pressing it down.



PROGRAM SELECTION

Wash Cycle Table

The table below shows which programs are best for the levels of food residue on them and how much detergent is needed. It also show various information about the programs. Consumption values and program duration are only indicative except for ECO program.

(●) indicates that the program uses rinse aid in the last rinse.

Program	Description Of Cycle	Detergent Pre/Main Wash	Running Time (min)	Energy (kWh)	Water (L)	Rinse Aid
 (IEC 60436)	Wash(50°C) Rinse Rinse(40°C) Drying	$\frac{22g}{1 \text{ or } 2 \text{ pieces}}$	235	0.645	9.8	●
 Universal	Prewash Wash(60°C) Rinse Rinse(65-72°C) Drying	$\frac{4/18g}{1 \text{ or } 2 \text{ pieces}}$	150	1.185-1.290	13.9	●
 Intensive	Prewash Wash(60°C) Rinse Rinse(65-72°C) Drying	$\frac{4/18g}{1 \text{ or } 2 \text{ pieces}}$	175	1.275-1.385	13.9	●
 Auto	Prewash(45°C) Wash(55-65°C) Rinse Rinse Rinse(55-65°C) Drying	$\frac{4/18g}{1 \text{ or } 2 \text{ pieces}}$	150	0.930-1.470	10.4-17.2	●
 Hygiene	Prewash Wash(72°C) Rinse Rinse(65-72°C) Drying	$\frac{4/18g}{1 \text{ or } 2 \text{ pieces}}$	195	1.510-1.615	13.9	●
 Glass	Prewash Wash(45°C) Rinse Rinse(55-60°C) Drying	$\frac{4/18g}{1 \text{ or } 2 \text{ pieces}}$	120	0.850-0.925	13.9	●

Program	Description Of Cycle	Detergent Pre/Main	Running Time(min)	Energy (kWh)	Water (L)	Rinse Aid
 58 min	Wash(60°C)	$\frac{22\text{g}}{1 \text{ piece}}$	58	0.905	10.5	●
	Rinse Rinse(55-60°C) Drying					
 Soak	Prewash	/	15	0.115	3.7	○

 **NOTE:**

ECO : The ECO program is suitable to clean normally soiled tableware, that (IEC60436) for this use, it is the most efficient program in terms of its combined energy and water consumption, and it is used to assess compliance with the EU ecodesign legislation.

• Saving Energy

1. Pre-rinsing of tableware items leads to increased water and energy consumption and is not recommended.
2. Washing tableware in a household dishwasher usually consumes less energy and water in the use phase than hand dishwashing when the household dishwasher is used according to the instructions.

• Starting A Program

1. Pull out the lower and upper basket, load the dishes and push them back.
2. Add the detergent in the dispenser.
3. Insert the plug into the socket. For the power supply specification please refer to last page "Product information sheet".
Make sure that the water supply is turned on within specified range of pressure.
4. Open the door, Press the Power button.
5. Choose a program and press the Start button. Then close the door, the dishwasher will start the program.

• Changing The Program Mid-cycle

A program can only be changed if it has been running only for a short period of time, otherwise the detergent may have already been released or the the wash water with detergent has already been drained. If this is the case, the dishwasher needs to be reset and the detergent dispenser must be refilled. To reset the dishwasher, follow the instructions below:

1. Open the door a little to stop the dishwasher, after the spray arm stopped working, you can open the door completely.
2. Press any one of Programs button more than three seconds the machine will be in program selection mode.
3. You can change the program to the desired cycle setting.
4. Press the Start button and close the door, the dishwasher will restart to run.

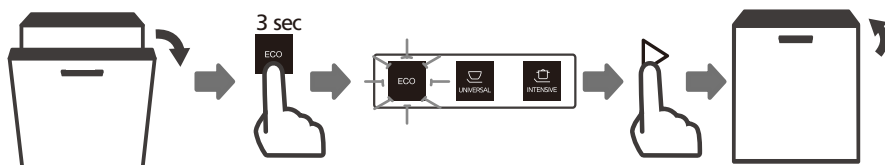

Forget To Add A Dish?

A forgotten dish can be added any time before the detergent dispenser opens. If this is the case, follow the instructions below:

1. Press the Start/Pause button to pause the washing.
2. After the spray arms stopped working, you can open the door completely.
3. Add the forgotten dishes.
4. Close the door.
5. Press the Start/Pause button after 10 seconds, the dishwasher will start.

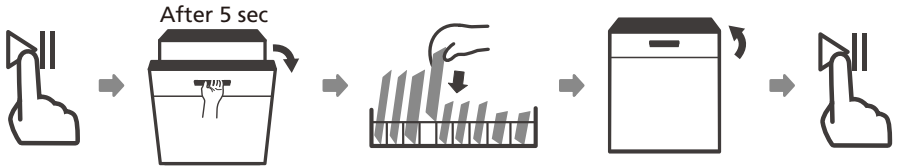

⚠ WARNING



It is dangerous to open the door mid-cycle, as hot steam may scald you.

Auto Open

After washing, the door will open automatically to achieve better drying effect.



NOTE:

The dishwasher door must not be blocked when set to open automatically. This can disrupt door lock functionality.



ERROR CODES

If there is a malfunction the dishwasher will display an error code. The following table shows possible error codes and their causes.

Codes	Meanings	Possible Causes
E1	Longer inlet time.	Faucets is not opened, or water intake is restricted, or water pressure is too low.
E3	Not reaching required temperature.	Malfunction of heating element.
E4	Overflow.	Some element of dishwasher leaks.
E8	Failure of orientation of distributary valve.	Open circuit or break of distributary valve.
EC	Washing control system fail.	PCB or motor fail.
Ed	Failure of communication between main circuit board with display circuit board.	Open circuit or break wiring for the communication

WARNING

- If overflow occurs, turn off the main water supply before calling a service.
- If there is water in the base pan because of an overfill or small leak, the water should be removed before restarting the dishwasher.
- If there is an error code that cannot be solved, please request professional assistance.

TECHNICAL INFORMATION

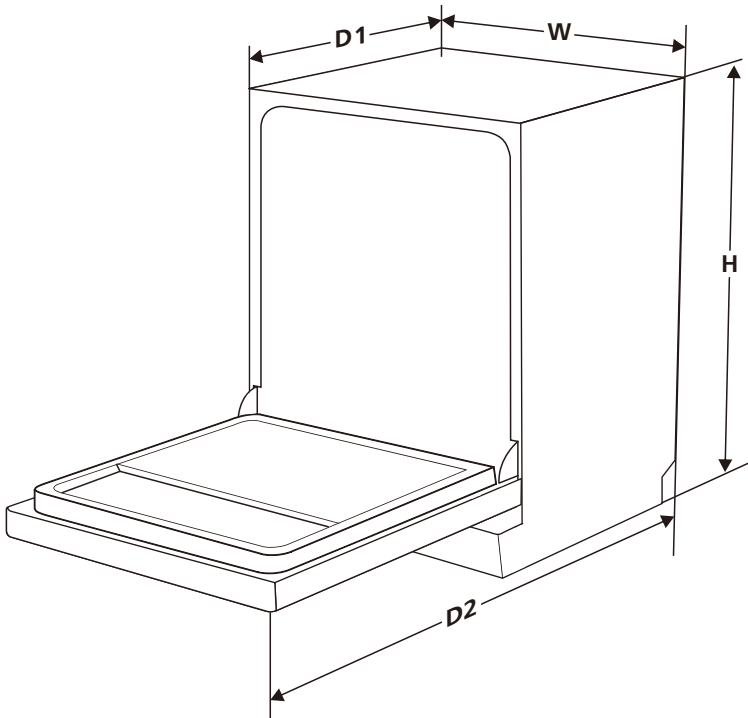

Height (H)	815mm
Width (W)	598mm
Depth (D1)	550mm (with the door closed)
Depth (D2)	1150mm (with the door opened 90°)

Product information sheet (EN60436)

Supplier's name or trade mark: KUPPERSBUSCH

Supplier's address (b): Küppersbusch Hausgeräte GmbH Im Welterbe 2 45141 Essen - Germany

Model identifier: G6564.0V

General product parameters:

Parameter	Value	Parameter	Value	
Rated capacity (a) (ps)	14	Dimensions in cm	Height	82
			Width	60
			Depth	55
EEI (a)	37,9	Energy efficiency class (a)	B (c)	
Cleaning performance index (a)	1,125	Drying performance index (a)	1,065	
Energy consumption in kWh [per cycle], based on the eco programme using cold water fill. Actual energy consumption will depend on how the appliance is used.	0,645	Water consumption in litres [per cycle], based on the eco program. Actual water consumption will depend on how the appliance is used and on the hardness of the water.	9.8	
Program duration (a) (h:min)	3:55	Type	Free standing	
Airborne acoustical noise emissions (a) (dB(A) re 1 pW)	42	Airborne acoustical noise emission class (a)	B (c)	
Off-mode (W)	N/A	Standby mode (W)	0,99	
Delay start (W) (if applicable)	4,00	Networked standby (W) (if applicable)	N/A	

Minimum duration of the guarantee offered by the supplier (b): 24 months

Additional information:

Weblink to the supplier's website, where the information in point 6 of Annex II to Commission Regulation (EU) 2019/2022 (1) (b) is found: www.home-kueppersbusch.com

(a) for the eco program.

(b) changes to these items shall not be considered relevant for the purposes of paragraph 4 of Article 4 of Regulation (EU) 2017/1369.

(c) if the product database automatically generates the definitive content of this cell the supplier shall not enter these data.

(1) Commission Regulation (EU) 2019/2022 of 1 October 2019 laying down eco design requirements for household dishwashers pursuant to Directive 2009/125/EC of the European Parliament and of the Council amending Commission Regulation (EC) No 1275/2008 and repealing Commission Regulation (EU) No 1016/2010 (see page 267 of this Official Journal).

Küppersbusch

Küppersbusch Hausgeräte GmbH

Im Welterbe 2, D-45141 Essen

Telefon: (0209) 401-0

www.home-kueppersbusch.com

