

A  
B  
C  
D  
E  
F  
G  
H  
I  
J

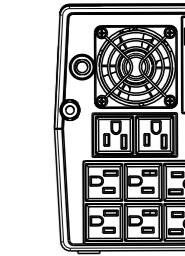
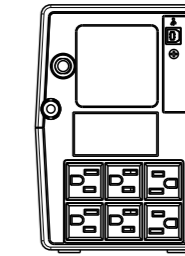
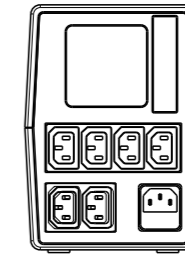
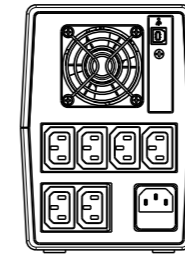
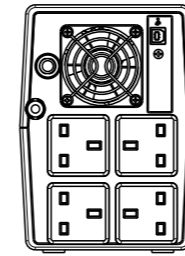
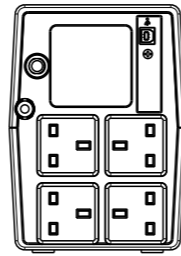
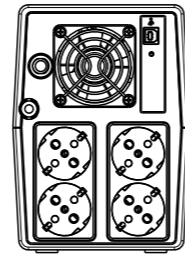
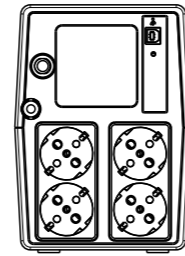
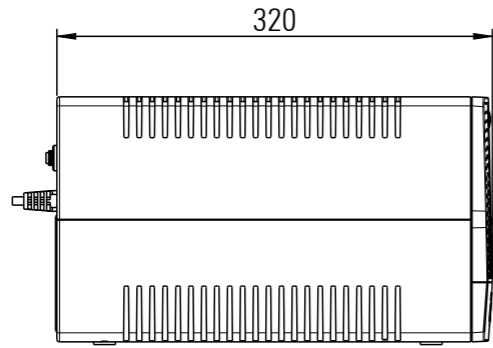
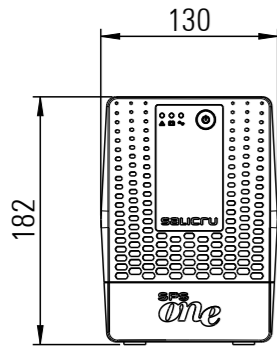

662AF000005 - SPS.1500.ONE  
662AF000006 - SPS.2000.ONE

662AF000011 - SPS.1500.ONE UK  
662AF000012 - SPS.2000.ONE UK

662AF000017 - SPS.1500.ONE IEC  
662AF000018 - SPS.2000.ONE IEC

662AF000025 - SPS.1000.ONE A UL

662AG000013 - SPS.1500.ONE BL  
662AG000016 - SPS.2000.ONE BL

662AG000015 - SPS.1500.ONE BL UK  
662AG000018 - SPS.2000.ONE BL UK

662AG000014 - SPS.1500.ONE BL IEC  
662AG000017 - SPS.2000.ONE BL IEC

662AF000004 - SPS.1100.ONE

662AF000010 - SPS.1100.ONE UK

662AF000016 - SPS.1100.ONE IEC

662AF000021 - SPS.1100.ONE IEC SC

662AF000026 - SPS.1500.ONE A UL  
662AF000027 - SPS.2000.ONE A UL

662AG000010 - SPS.1100.ONE BL

662AG000012 - SPS.1100.ONE BL UK

662AG000011 - SPS.1100.ONE BL IEC

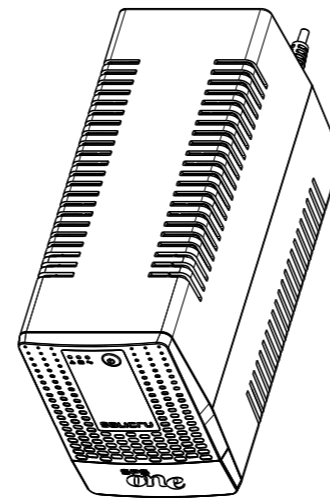

1.- CHANGE VIEW

| MATERIAL |           |        |           | CUT TOLERANCES          | FOLD TOLERANCES       |
|----------|-----------|--------|-----------|-------------------------|-----------------------|
| COATING  |           |        |           | < 100mm: ±0.1mm         | < 500mm: ±0.5mm       |
| MATERIAL | THICKNESS | COLOUR | FINISHING | 100 TO < 500mm: ±0.2mm  | 500 TO < 1000mm: ±1mm |
|          |           |        |           | 500 TO < 1000mm: ±0.3mm | > = 1000mm: ±2mm      |
|          |           |        |           | > = 1000mm: ±0.5mm      | DRILL TOLERANCES      |
|          |           |        |           | ANGULAR TOLERANCES      | < Ø 6mm: ±0.1mm       |
|          |           |        |           | ±0.5°                   | > = Ø 6mm: ±0.2mm     |

|                              |  |  |                    |
|------------------------------|--|--|--------------------|
|                              | N° DIAGRAM<br>FB100E01   |  |                    |
|                              | PAGE / PAGES<br>1 / 1  |  |                    |
| DRAWN BY<br>SERGI CASADEMUNT | <b>VIEWS &amp; DIMENSIONS SPS.1100-2000.ONE</b><br>UK - IEC - IEC SC - A UL - BL |  |                    |
| DATE<br>22/06/2023           | FORMAT: A3   |  | E: 9/50   REMARKS: |