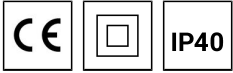
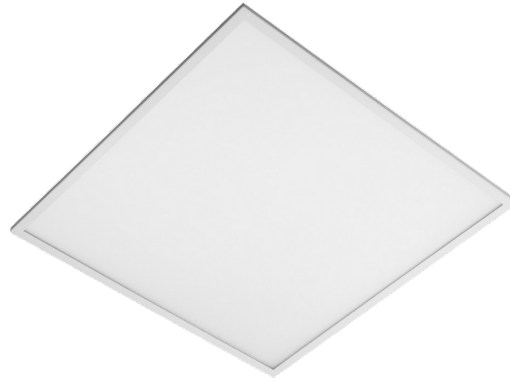
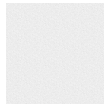

ARUBA 1 (ARU-80002)**Product description**

600x600 mm

**Luminaire Structure**

- Formed sheet steel body with powder coating
- White painted metal sheet
- UV & flame resistant, chemical & salt stable PVC
- Stainless steel fasteners in grade 304 with zinc flake coating (ZFC)
- Micro prismatic PMMA diffuser for better glare control
- Remote driver (included)
- Recessed and surface mounted options
- Accessories: Aluminium frame for surface installation & Aluminium frame for recessed installation of fitting into gypsum plasterboard

Optic**P****Product colour**

03 - White (RAL 9003)

ARUBA 1 (ARU-80002)

Technical information

Material	Aluminium
Light source	2 x 66 LED
Power	38 W
Lumen	3850 lm
Efficacy	101 lm/W
Driver option	Remote driver (included)

Driver	Constant current (CC)
Input voltage	220-240 V 50/60 Hz
Optic	P
Optic value	Micro-prismatic
CCT / CRI	3000K CRI80, 4000K CRI80
Dimming type	On/Off, DALI

Product colours	White
Weight	4.0 kg
Operating temperature	-20 °C to 40 °C
Lens / Reflector / Optic	Micro prismatic PMMA diffuser for better glare control

ARU-80002

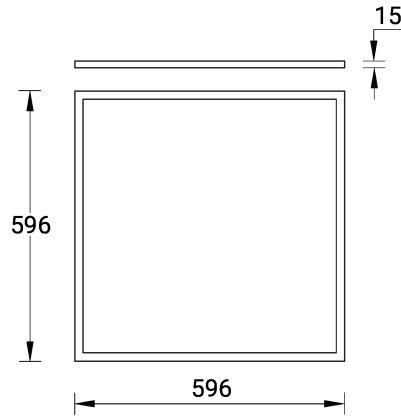

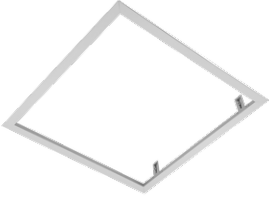
ARUBA 1 (ARU-80002)**Accessory**

Frame for recessed installation
of fittings into gypsum
plasterboard ceiling SQUARE
(White)
A83081

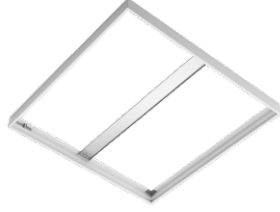

Frame for surface installation
SQUARE (White)
A83281



Wireless bluetooth converter
A90291



Xpress wireless switch
A90591



DALI Control System
Control-DALI