

PITTSBURGH 2 (PIB-50012) (Version 1)



Product description

Medium



microPrim™

Luminaire Structure

- Extruded aluminium housing
- Pre-treated before powder coating ensuring high corrosion resistance
- Galvanized steel arm mounted
- Thermal heat dissipation body
- Single cable entry, through wiring upon request
- One IP68 connector supplied with 0.2 m of 3x1.0 sqmm outdoor cable
- Stainless steel fasteners in grade 304 with zinc flake coating (ZFC)
- Durable silicone rubber gasket
- High-efficiency polycarbonate lens
- Clear toughened glass
- Integral control gear
- Surge protection 10kV

Optic

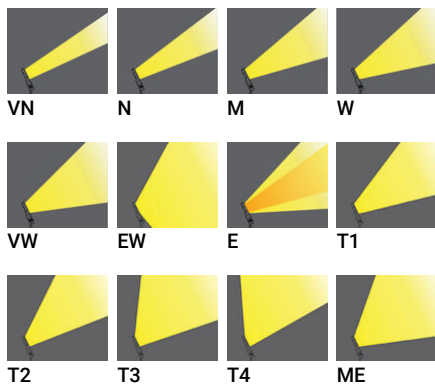

Product colour

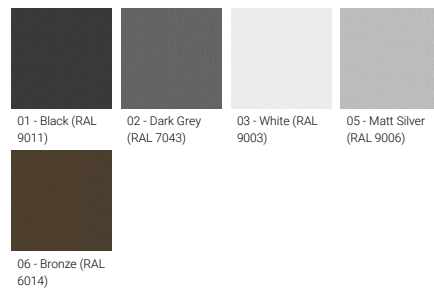

Special finishes upon request



PITTSBURGH 2 (PIB-50012) (Version 1)

Technical information

Material	Aluminium
Light source	2 x 36 LED
Power	113 W
Lumen	10433 - 16865 lm
Efficacy	92 - 149 lm/W
Driver option	Integral control gear
Driver	Constant current (CC)
Input voltage	220-240V 50/60Hz
Optic	VN, N, M, W, VW, EW, E, T1, T2, T3, T4, ME

Optic value	5°, 12°, 25°, 53°, 65°, 106°, 94°x25°, 145°x67°, 137°x40°, 132°x32°, 94°x64°, 124°x60°
CCT / CRI	3000K CRI80, 4000K CRI80
Bug	B1-U0-G1, B2-U0-G1, B3-U0-G0, B3-U0-G3, B4-U0-G1, B5-U0-G0, B5-U0-G1
ULR	<1%
ULOR	<1%
CIE flux code n°3	100, 97, 98, 99
Dimming type	On/Off, 1-10V, DALI
Product colours	Black, Dark Grey, White, Matt Silver, Bronze, Concrete - Urban, Softscape - Urban, Stone - Urban, Corten - Urban, Oak - Woodland, Walnut - Woodland, Pine - Woodland
Weight	13.0 kg

Operating temperature	-20 °C to 50 °C
EPA (m2)	0.191
Cable	One IP68 connector supplied with 0.2 m of 3x1.0 sqmm outdoor cable
Through wiring	Single cable entry, through wiring upon request
Lens / Reflector / Optic	High-efficiency polycarbonate lens, Clear toughened glass
MacAdam Ellipse	3 SDCM
Lifetime L90B10 (hours)	> 120,000
Variants (On/Off, 1-10V, DALI)	Compatible with EN/ IEC 60598-2-22: Suitable for emergency installations as central supply, non-maintained (Z0)

PIB-50012

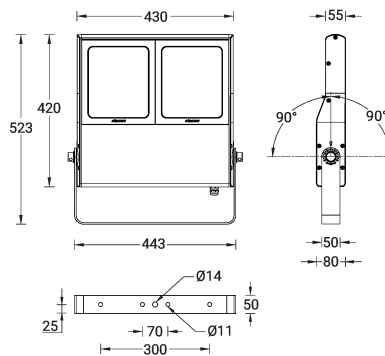

Accessory



Anti-glare visor
A54931



Anti-glare louvre
A55031

Please contact the factory for technical details if you wish to use Anti-glare accessories, Colour filters, Lenses and slip glasses in combination.