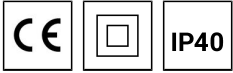
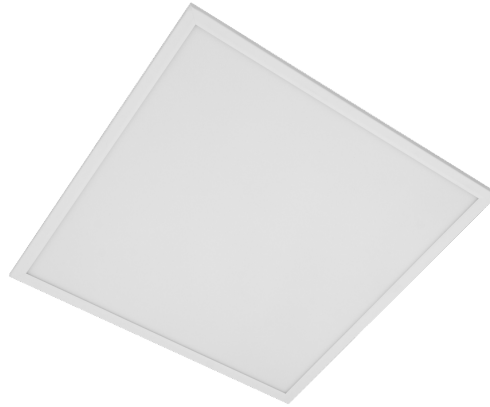
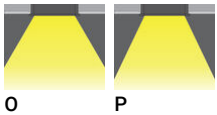

VIENNA 1 (VIE-80004)**Product description**

600x600 mm

**Luminaire Structure**

- Formed sheet steel body with powder coating
- White painted metal sheet
- UV & flame resistant, chemical & salt stable PVC
- Stainless steel fasteners in grade 304 with zinc flake coating (ZFC)
- PMMA diffuser with Opal (UGR <19) and micro prismatic (UGR <13) options for better glare control
- Integral control gear
- Recessed and surface mounted options
- Accessories: Aluminium frame for surface installation & Aluminium frame for recessed installation of fitting into gypsum plasterboard

Optic

O

P

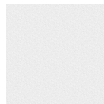
Product colour

03 - White (RAL 9003)

VIENNA 1 (VIE-80004)

Technical information

Material	Aluminium	Driver option	Integral control gear	CCT / CRI	3000K CRI90, 4000K CRI90
Light source	2 x 91 LED	Driver	Constant current (CC)	Dimming type	On/Off
Power	57 W	Input voltage	220-240 V 50/60 Hz	Product colours	White
Lumen	6000 - 6200 lm	Optic	O, P	Weight	5.0 kg
Efficacy	105 - 109 lm/W	Optic value	Opal, Micro-prismatic	Operating temperature	-20 °C to 40 °C

VIE-80004

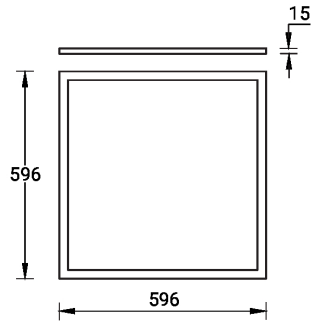

Accessory

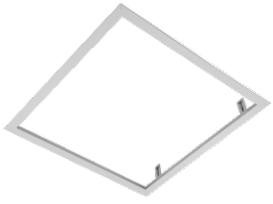

Frame for recessed installation
of fittings into gypsum
plasterboard ceiling SQUARE
(White)
A83081

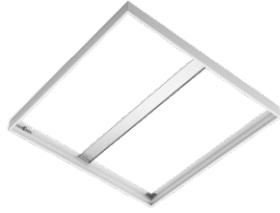

Frame for surface installation
SQUARE (White)
A83281



Wireless bluetooth converter
A90291



Xpress wireless switch
A90591
