

FORREY 7 (FOR-10131-SB)



Product description

Ø186 - 1179 mm - With integrated security core (Anti-traffic)



Luminaire Structure

- Die-cast aluminium housing and frame
- Extruded aluminium column
- Pre-treated before powder coating ensuring high corrosion resistance
- Models with shade will have colour white coating at inside of shade luminaire and outside surface coating according to colour of luminaire
- Single cable entry
- One IP68 connector supplied with 0.2 m of 3x1.0 sqmm outdoor cable
- Stainless steel fasteners in grade 304 with zinc flake coating (ZFC)
- Durable silicone rubber gasket
- High-efficiency PMMA lens
- Integral control gear
- FORREY luminaires with opal lens and colder than 3000K CCT do not meet the IDA certification requirements

Optic

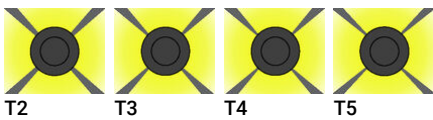

Product colour



Special finishes upon request



FORREY 7 (FOR-10131-SB)

Technical information

Light source	1 COB
Power	48 W
Lumen	4221 - 4780 lm
Efficacy	89 - 101 lm/W
Driver option	Integral control gear
Driver	Constant current (CC)
Input voltage	220-240 V 50/60 Hz
Optic	T2, T3, T4, T5

Optic value	142°x87°, 131°x100°, 128°x118°, 143°x89°
CCT / CRI	3000K CRI80, 4000K CRI80
Dimming type	On/Off, 1-10V, DALI
Product colours	Black, Dark Grey, White, Matt Silver, Bronze, Concrete - Urban, Softscape - Urban, Stone - Urban, Corten - Urban, Oak - Woodland, Walnut - Woodland, Pine - Woodland
Weight	37.5 kg
Operating temperature	-20 °C to 40 °C
Cable	One IP68 connector supplied with 0.2 m of 3x1.0 sqmm outdoor cable
Through wiring	Single cable entry

Lens / Reflector / Optic	High-efficiency PMMA lens
MacAdam Ellipse	3 SDCM
Lifetime L90B10 (hours)	> 50,700
Lifetime L80B10 (hours)	> 63,500
Lifetime L80B50 (hours)	> 63,500
Variants (DALI)	Compatible with EN/ IEC 60598-2-22: Suitable for emergency installations as central supply, non-maintained (Z0)

FOR-10131-SB

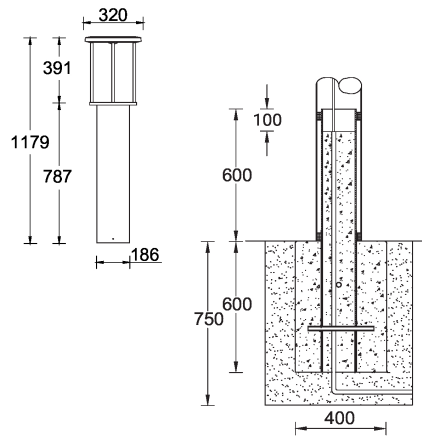

FORREY 7 (FOR-10131-SB)

Accessory



DALI Control System
Control-DALI
