

VANCOUVER 40 (VA-10161)



Product description

240x240 mm - 1000 mm - No decorative pattern



microPrim™

Luminaire Structure

- Die-cast aluminium housing
- Extruded aluminium column
- Pre-treated before powder coating ensuring high corrosion resistance
- Single cable entry
- One IP68 connector supplied with 0.2 m of 3x1.0 sqmm outdoor cable
- Stainless steel fasteners in grade 304 with zinc flake coating (ZFC)
- Durable silicone rubber gasket
- High-efficiency polycarbonate lens
- Clear toughened glass
- Integral control gear

Optic



G

Product colour



Special finishes upon request



VANCOUVER 40 (VA-10161)

Technical information

Material	Aluminium
Light source	1 COB
Power	21 W
Lumen	600 - 635 lm
Efficacy	29 - 30 lm/W
Driver option	Integral control gear
Driver	Constant current (CC)
Input voltage	220-240 V 50/60 Hz
Optic	G

Optic value	76°
CCT / CRI	3000K CRI80, 4000K CRI80
Bug	B1-U0-G0
ULR	1%
ULOR	1%
CIE flux code n°3	99
Dimming type	On/Off, 1-10V, DALI
Product colours	Black, Dark Grey, White, Matt Silver, Bronze, Concrete - Urban, Softscape - Urban, Stone - Urban, Corten - Urban, Oak - Woodland, Walnut - Woodland, Pine - Woodland
Weight	14.0 kg

Operating temperature	-20 °C to 40 °C
Cable	One IP68 connector supplied with 0.2 m of 3x1.0 sqmm outdoor cable
Through wiring	Single cable entry
Lens / Reflector / Optic	High-efficiency polycarbonate lens, Clear toughened glass
MacAdam Ellipse	3 SDCM
Lifetime L90B10 (hours)	> 61,000
Variants (On/Off, 1-10V, DALI)	Compatible with EN/ IEC 60598-2-22: Suitable for emergency installations as central supply, non-maintained (Z0)

VA-10161

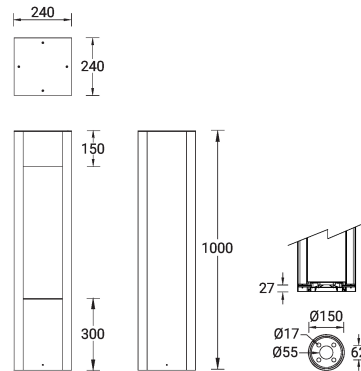

VANCOUVER 40 (VA-10161)

Accessory



Anchor bolt
A10291



DALI Control System
Control-DALI