

PITTSBURGH 2 (PIB-50014)



Product description

Medium - RGBW



microPrim™

Luminaire Structure

- Extruded aluminium housing
- Pre-treated before powder coating ensuring high corrosion resistance
- Galvanized steel arm mounted
- Thermal heat dissipation body
- Single cable entry, through wiring upon request

- Three IP68 connectors supplied with 0.2 m of 3x1.0 sqmm outdoor cable and 2x0.2 m of 2x0.5 sqmm outdoor shielded cable
- Stainless steel fasteners in grade 304 with zinc flake coating (ZFC)
- Durable silicone rubber gasket
- High-efficiency polycarbonate lens
- Clear toughened glass

- Integral control gear
- Surge protection 10kV

Optic

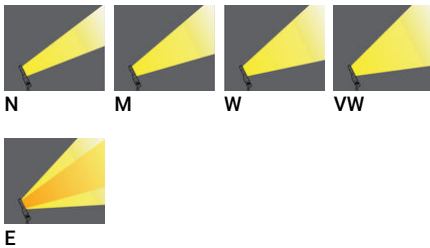

Product colour

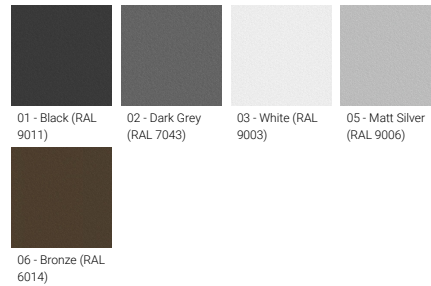

Special finishes upon request



PITTSBURGH 2 (PIB-50014)

Technical information

Material	Aluminium
Light source	2 x 36 LED
Power	80 W
Lumen	3962 - 5071 lm
Efficacy	50 - 63 lm/W
Driver option	Integral control gear

Driver	Constant current (CC)
Input voltage	220-240 V 50/60 Hz
Optic	N, M, W, VW, E
Optic value	9°, 16°, 33°, 64°, 43°x10°
CCT / CRI	RGBW30, RGBW40
Dimming type	DMX/RDM

Product colours	Black, Dark Grey, White, Matt Silver, Bronze, Concrete - Urban, Softscape - Urban, Stone - Urban, Corten - Urban, Oak - Woodland, Walnut - Woodland, Pine - Woodland
Weight	13.0 kg
EPA (m2)	0.191
Cable	Three IP68 connectors supplied with 0.2 m of 3x1.0 sqmm outdoor cable and 2x0.2 m of 2x0.5 sqmm outdoor shielded cable
Through wiring	Single cable entry, through wiring upon request
Lens / Reflector / Optic	High-efficiency polycarbonate lens, Clear toughened glass

PIB-50014

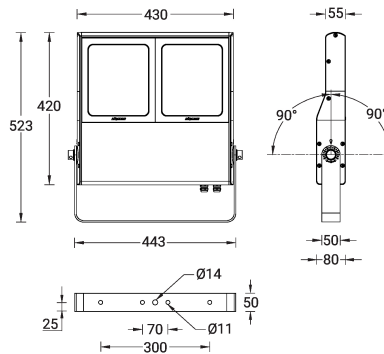

PITTSBURGH 2 (PIB-50014)**Accessory**



Anti-glare visor
A54931



Anti-glare louvre
A55031



DMX/RDM Control System
Control-DMX-RDM

Please contact the factory for technical details if you wish to use Anti-glare accessories, Colour filters, Lenses and slip glasses in combination.