

POWERVISION 6 (PW69-GP054)



Luminaire Structure

- Extruded aluminium housing
- Pre-treated before powder coating ensuring high corrosion resistance
- Thermal heat dissipation body
- Single cable entry, through wiring upon request
- One IP68 connector supplied with 0.2 m of 3x1.0 sqmm outdoor cable
- Stainless steel fasteners in grade 304 with zinc flake coating (ZFC)
- Durable silicone rubber gasket
- Clear toughened glass
- Integral control gear

Optic

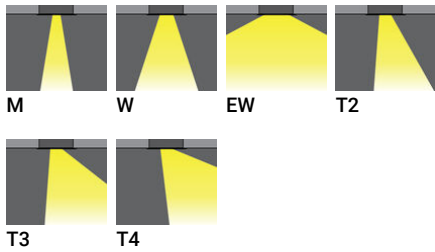

Product colour

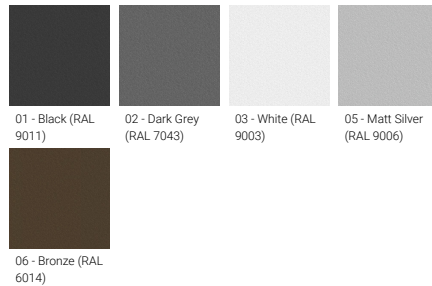

Special finishes upon request

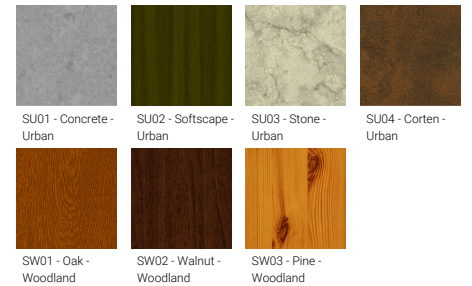

POWERVISION 6 (PW69-GP054)

Technical information

Material	Aluminium
Light source	48 LED
Power	52 W
Lumen	6105 - 7046 lm
Efficacy	117 - 136 lm/W
Driver option	Integral control gear
Driver	Constant current (CC)
Input voltage	220-240 V 50/60 Hz

Optic	M, W, EW, T2, T3, T4
Optic value	27°, 51°, 122°, 141°x52°, 141°x69°, 99°x79°
CCT / CRI	3000K CRI80, 4000K CRI80
Dimming type	On/Off, 1-10V, DALI
Product colours	Black, Dark Grey, White, Matt Silver, Bronze, Concrete - Urban, Softscape - Urban, Stone - Urban, Corten - Urban, Oak - Woodland, Walnut - Woodland, Pine - Woodland
Weight	11.0 kg
Operating temperature	-20 °C to 40 °C
Cable	One IP68 connector supplied with 0.2 m of 3x1.0 sqmm outdoor cable

Through wiring	Single cable entry, through wiring upon request
Lens / Reflector / Optic	Clear toughened glass
MacAdam Ellipse	3 SDCM
Lifetime L90B10 (hours)	> 90,000
Lifetime L80B10 (hours)	> 90,000
Lifetime L80B50 (hours)	> 90,000

PW69-GP054

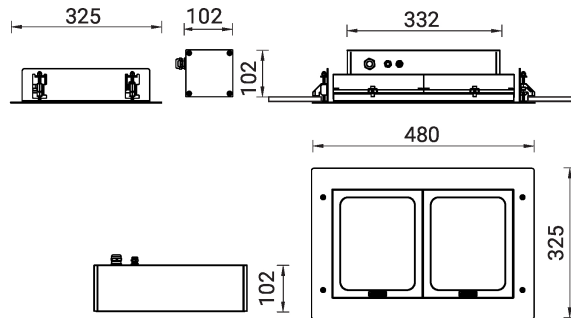

POWERVISION 6 (PW69-GP054)**Accessory**



DALI Control System
Control-DALI
