

OULU 5 (OUL-80423)



Product description

Down - 180° - R750 - RGBW



microPrim™

Luminaire Structure

- Die-cast aluminium end-caps and extruded aluminium profile with powder coating
- Multiple angles available
- Passive thermal management
- Stainless steel fasteners in grade 304 with zinc flake coating (ZFC)

- Opal PMMA diffuser (UGR <19) for glare control
- Integral control gear
- Steel brackets for ceiling down mounting option
- Up and down light distribution options

- Wireless control available through Bluetooth connection

Optic



0

Product colour



01 - Black (RAL 9011) 03 - White (RAL 9003) 05 - Matt Silver (RAL 9006)

Special finishes upon request



SU01 - Concrete - Urban SU02 - Softscape - Urban SU03 - Stone - Urban SU04 - Corten - Urban



SW01 - Oak - Woodland SW02 - Walnut - Woodland SW03 - Pine - Woodland

OULU 5 (OUL-80423)

Technical information

Material	Aluminium
Light source	768 LED
Power	43 W
Lumen	1434 lm
Efficacy	33 lm/W
Driver option	Integral control gear

Driver	Constant current (CC)
Input voltage	220-240 V 50/60 Hz
Optic	0
Optic value	Opal
CCT / CRI	RGBW40
Dimming type	Bluetooth

Product colours	Black, White, Matt Silver, Concrete - Urban, Softscape - Urban, Stone - Urban, Corten - Urban, Oak - Woodland, Walnut - Woodland, Pine - Woodland
Weight	5.4 kg
Operating temperature	-20 °C to 40 °C
Variants (Bluetooth)	Compatible with EN/ IEC 60598-2-22: Suitable for emergency installations as central supply, non-maintained (Z0)

OUL-80423

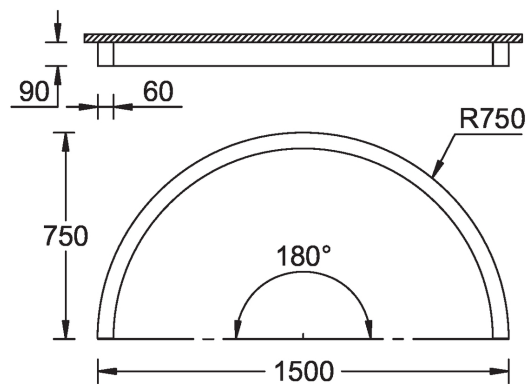

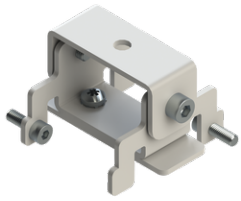
OULU 5 (OUL-80423)**Accessory**

Ceiling-mounting bracket (40 mm profile)
A81381



Continuous-coupler bracket
A81781



Xpress wireless switch
A90591



DALI Control System
Control-DALI