

MIC 7 (MI-50441)



Product description

Small



microPrim™

Luminaire Structure

- Die-cast aluminium housing
- Pre-treated before powder coating ensuring high corrosion resistance
- Single cable entry
- Stainless steel fasteners in grade 304 with zinc flake coating (ZFC)
- Durable silicone rubber gasket
- High-efficiency PMMA lens
- Clear toughened glass
- Integral control gear

Optic

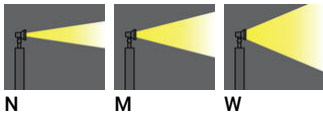

Product colour

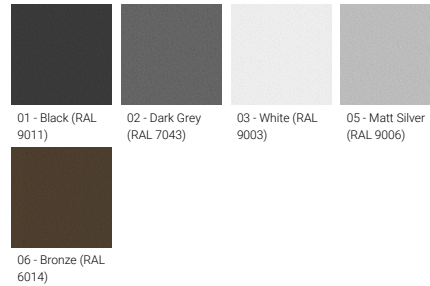

Special finishes upon request

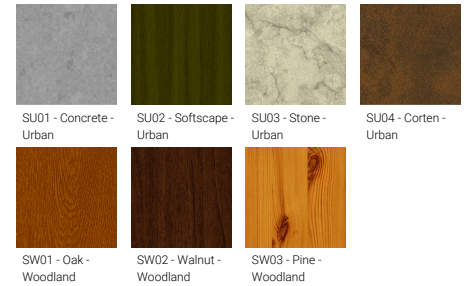

MIC 7 (MI-50441)

Technical information

Material	Aluminium
Light source	7 LED
Power	13 W
Lumen	938 - 1099 lm
Efficacy	72 - 85 lm/W
Driver option	Integral control gear
Driver	Constant current (CC)
Input voltage	220-240 V 50/60 Hz

Optic	N, M, W
Optic value	19°, 27°, 40°
CCT / CRI	3000K CRI80, 4000K CRI80
Dimming type	On/Off, 1-10V, DALI
Product colours	Black, Dark Grey, White, Matt Silver, Bronze, Concrete - Urban, Softscape - Urban, Stone - Urban, Corten - Urban, Oak - Woodland, Walnut - Woodland, Pine - Woodland
Weight	3.3 kg
Operating temperature	-20 °C to 40 °C
Through wiring	Single cable entry

Lens / Reflector / Optic	High-efficiency PMMA lens, Clear toughened glass
MacAdam Ellipse	3 SDCM
Lifetime L90B10 (hours)	> 120,000
Lifetime L80B10 (hours)	> 120,000
Lifetime L80B50 (hours)	> 120,000
Variants (On/Off, 1-10V, DALI)	Compatible with EN/ IEC 60598-2-22: Suitable for emergency installations as central supply, non-maintained (Z0)

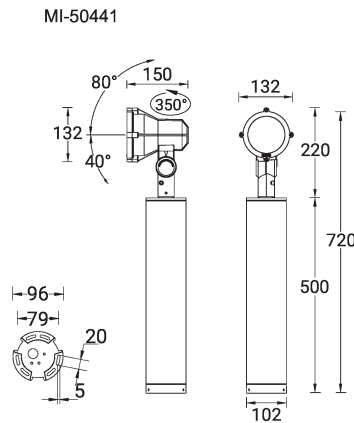

MIC 7 (MI-50441)**Accessory**



Anti-glare visor
A50131



Anti-glare hood
A51531

Please contact the factory for technical details if you wish to use Anti-glare accessories, Colour filters, Lenses and slip glasses in combination.