

NYBRO 11 (NYB-81092-RE)



Product description

Down - L90° corner - 50x80 mm - 355 mm



microPrim™

Luminaire Structure

- Die-cast aluminium end-caps and extruded aluminium profile with powder coating
- Passive thermal management
- Stainless steel fasteners in grade 304 with zinc flake coating (ZFC)
- PMMA diffuser with Opal (UGR <19) and micro prismatic (UGR <13) options for better glare control
- Integral control gear
- Cut the connection angle according to the shape
- Stainless steel brackets and screws for mounting
- Down light distribution only
- Wireless control available through Bluetooth connection
- Daylight and occupancy sensor options

Optic



Product colour

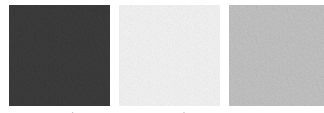

01 - Black (RAL 9011) 03 - White (RAL 9003) 05 - Matt Silver (RAL 9006)

Special finishes upon request

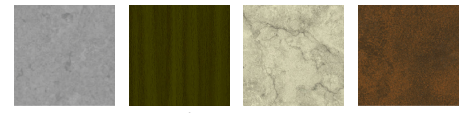

SU01 - Concrete - Urban SU02 - Softscape - Urban SU03 - Stone - Urban SU04 - Corten - Urban



SW01 - Oak - Woodland SW02 - Walnut - Woodland SW03 - Pine - Woodland

NYBRO 11 (NYB-81092-RE)

Technical information

Material	Aluminium
Light source	72 LED
Power	14 W
Lumen	987 - 1195 lm
Efficacy	71 - 85 lm/W
Driver option	Integral control gear
Driver	Constant current (CC)

Input voltage	220-240 V 50/60 Hz
Optic	O, P
Optic value	Opal, Micro-prismatic
CCT / CRI	3000K CRI80, 4000K CRI80
Dimming type	On/Off, DALI
Product colours	Black, White, Matt Silver, Concrete - Urban, Softscape - Urban, Stone - Urban, Corten - Urban, Oak - Woodland, Walnut - Woodland, Pine - Woodland
Weight	2.1 kg

Operating temperature	-20 °C to 40 °C
MacAdam Ellipse	3 SDCM
Lifetime L90B10 (hours)	> 23,000
Lifetime L80B10 (hours)	> 45,000
Lifetime L80B50 (hours)	> 50,000
Variants (On/Off, DALI)	Compatible with EN/ IEC 60598-2-22: Suitable for emergency installations as central supply, non-maintained (Z0)

NYB-81092-RE

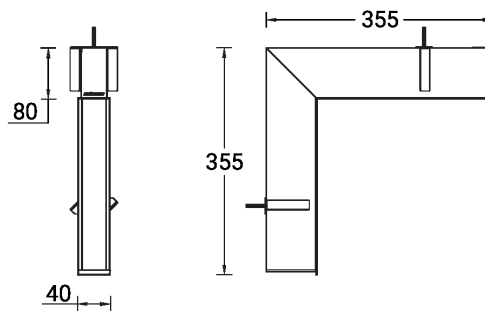

NYBRO 11 (NYB-81092-RE)**Accessory**



Continuous-coupler bracket
(40/50 mm Down profile)
A81881



DALI Control System
Control-DALI
