

VANCOUVER 51 (VA-20233)



Product description

240x240 mm - 4810 mm - Decorative pattern type 3
(Optic) - 3 projectors (Optic 2nd) IP65



microPrim™

Luminaire Structure

- Die-cast aluminium housing
- Extruded aluminium column
- Pre-treated before powder coating ensuring high corrosion resistance
- Single cable entry
- One IP68 connector supplied with 0.3 m of 3x1.0 sqmm outdoor cable
- Stainless steel fasteners in grade 304 with zinc flake coating (ZFC)
- Durable silicone rubber gasket
- High-efficiency optical reflector
- Clear toughened glass
- Integral control gear
- Maximum wind load resistance is 160 km/h
- Surge protection 10kV
- VANCOUVER luminaires with projectors on top and colder than 3000K CCT do not meet the IDA certification requirements

Optic

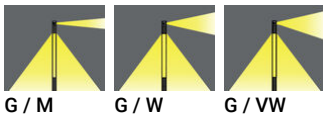

Product colour

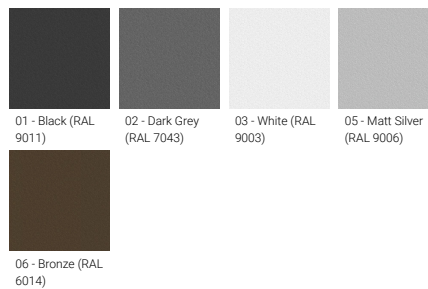

Special finishes upon request



VANCOUVER 51 (VA-20233)

Technical information

Material	Aluminium
Light source	1 COB & 2 x 1 COB (Projectors)
Power	103 W
Lumen	7545 - 7845 lm
Efficacy	73 - 76 lm/W
Driver option	Integral control gear
Driver	Constant current (CC)
Input voltage	220-240 V 50/60 Hz
Optic	G

Optic value	134°
Optic (2nd)	M, W, VW
Optic (2nd) value	23°, 32°, 43°
CCT / CRI	3000K CRI80, 4000K CRI80
Dimming type	On/Off, 1-10V, DALI
Product colours	Black, Dark Grey, White, Matt Silver, Bronze, Concrete - Urban, Softscape - Urban, Stone - Urban, Corten - Urban, Oak - Woodland, Walnut - Woodland, Pine - Woodland
Weight	60.8 kg
Operating temperature	-20 °C to 40 °C
EPA (m2)	1.154

Cable	One IP68 connector supplied with 0.3 m of 3x1.0 sqmm outdoor cable
Through wiring	Single cable entry
Lens / Reflector / Optic	High-efficiency optical reflector, Clear toughened glass
MacAdam Ellipse	3 SDCM
Lifetime L90B10 (hours)	> 109,000
Lifetime L80B10 (hours)	> 109,000
Lifetime L80B50 (hours)	> 109,000
Variants (On/Off, 1-10V, DALI)	Compatible with EN/ IEC 60598-2-22: Suitable for emergency installations as central supply, non-maintained (Z0)

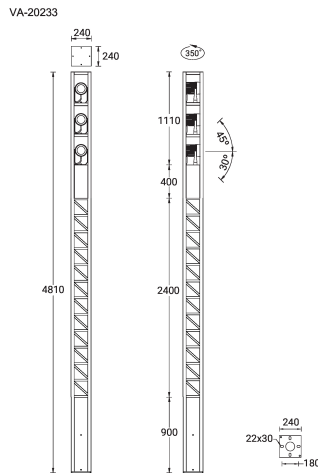

VANCOUVER 51 (VA-20233)**Accessory**



Circuit breaker box IP44
A21291



Root mount kit
A21391



DALI Control System
Control-DALI