

**OULU 10** (OUL-90304)



**Product description**

Down (Optic) & Up (Optic 2nd) - 90° - R500 - RGBW DMX



microPrim™

**Luminaire Structure**

- Extruded aluminium bended profile with powder coating
- Passive thermal management
- Stainless steel fasteners in grade 304 with zinc flake coating (ZFC)
- Opal PMMA diffuser (UGR <19) for glare control

- Remote driver (included)
- Stainless steel, adjustable, suspension (1.5 m) complete with electrical wires in white for mounting
- Up and down light distribution options
- Wireless control available through Bluetooth connection

- Daylight and occupancy sensor options

**Optic**



0

**Product colour**



01 - Black (RAL 9011)    03 - White (RAL 9003)    05 - Matt Silver (RAL 9006)

**Special finishes upon request**



SU01 - Concrete - Urban    SU02 - Softscape - Urban    SU03 - Stone - Urban    SU04 - Corten - Urban



SW01 - Oak - Woodland    SW02 - Walnut - Woodland    SW03 - Pine - Woodland

**OULU 10** (OUL-90304)

**Technical information**

<b>Material</b>	Aluminium
<b>Light source</b>	240 LED
<b>Power</b>	26 W
<b>Driver option</b>	Remote driver (included)
<b>Driver</b>	Constant current (CC)

<b>Input voltage</b>	220-240 V 50/60 Hz
<b>Optic</b>	O
<b>CCT / CRI</b>	RGBW40
<b>Dimming type</b>	DMX, DMX/RDM
<b>Product colours</b>	Black, White, Matt Silver, Concrete - Urban, Softscape - Urban, Stone - Urban, Corten - Urban, Oak - Woodland, Walnut - Woodland, Pine - Woodland

<b>Weight</b>	2.6 kg
<b>Operating temperature</b>	-20 °C to 40 °C
<b>Variants (DMX/RDM)</b>	Compatible with EN/ IEC 60598-2-22: Suitable for emergency installations as central supply, non-maintained (Z0)

OUL-90304

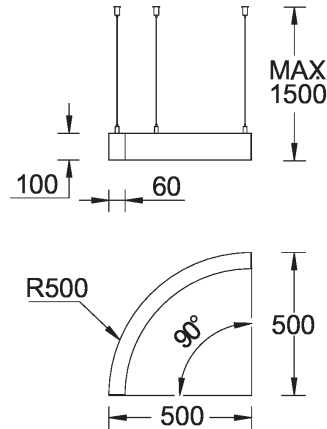

**OULU 10** (OUL-90304)**Accessory**

Continuous-coupler bracket  
**A81781**



Supply cable surface mounting  
box  
**A80981**



DMX Control System  
**Control-DMX**



DMX/RDM Control System  
**Control-DMX-RDM**