

OULU 11 (OUL-90424)



Product description

Down - 45° - R1500 - RGBW DMX



microPrim™

Luminaire Structure

- Extruded aluminium bended profile with powder coating
- Passive thermal management
- Stainless steel fasteners in grade 304 with zinc flake coating (ZFC)
- Opal PMMA diffuser (UGR <19) for glare control

- Remote driver (included)
- Stainless steel, adjustable, suspension (1.5 m) complete with electrical wires in white for mounting
- Up and down light distribution options
- Wireless control available through Bluetooth connection

- Daylight and occupancy sensor options

Optic



0

Product colour



01 - Black (RAL 9011) 03 - White (RAL 9003) 05 - Matt Silver (RAL 9006)

Special finishes upon request



SU01 - Concrete - Urban SU02 - Softscape - Urban SU03 - Stone - Urban SU04 - Corten - Urban



SW01 - Oak - Woodland SW02 - Walnut - Woodland SW03 - Pine - Woodland

OULU 11 (OUL-90424)

Technical information

Material	Aluminium
Light source	384 LED
Power	27 W
Lumen	776 lm
Efficacy	30 lm/W

Driver option	Remote driver (included)
Driver	Constant current (CC)
Input voltage	220-240 V 50/60 Hz
Optic	0
CCT / CRI	RGBW40

Dimming type	DMX, DMX/RDM
Product colours	Black, White, Matt Silver, Concrete - Urban, Softscape - Urban, Stone - Urban, Corten - Urban, Oak - Woodland, Walnut - Woodland, Pine - Woodland
Weight	3.1 kg
Operating temperature	-20 °C to 40 °C
Variants (DMX/RDM)	Compatible with EN/ IEC 60598-2-22: Suitable for emergency installations as central supply, non-maintained (Z0)

OUL-90424

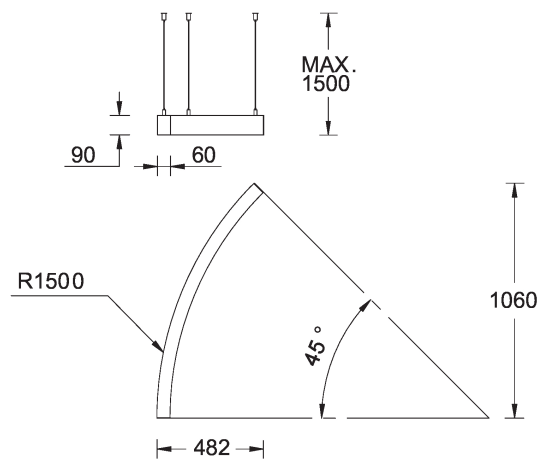

OULU 11 (OUL-90424)**Accessory**

Continuous-coupler bracket
A81781



Supply cable surface mounting
box
A80981



DMX Control System
Control-DMX



DMX/RDM Control System
Control-DMX-RDM