

OULU 7 (OUL-80821)**Product description**

Down - 45° - R1500 - White light

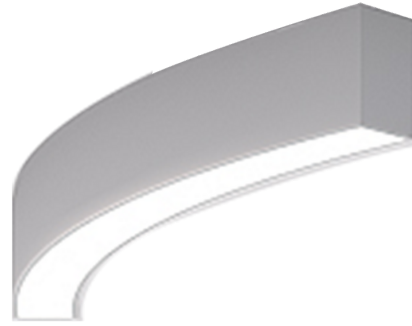

microPrim™

Luminaire Structure

- Die-cast aluminium end-caps and extruded aluminium profile with powder coating
- Multiple angles available
- Passive thermal management
- Stainless steel fasteners in grade 304 with zinc flake coating (ZFC)
- Opal PMMA diffuser (UGR <19) for glare control
- Integral control gear for On/Off (-ND), DALI (-DA). Remote driver is included for 1-10V (-DI)
- Steel brackets for ceiling down mounting option
- Up and down light distribution options
- Wireless control available through Bluetooth connection

Optic

0

Product colour

01 - Black (RAL 9011)

03 - White (RAL 9003)

05 - Matt Silver (RAL 9006)

Special finishes upon request

SU01 - Concrete - Urban

SU02 - Softscape - Urban

SU03 - Stone - Urban

SU04 - Corten - Urban



SW01 - Oak - Woodland



SW02 - Walnut - Woodland



SW03 - Pine - Woodland

OULU 7 (OUL-80821)

Technical information

Material	Aluminium
Light source	144 LED
Power	18 W
Lumen	1663 - 1732 lm
Efficacy	92 - 96 lm/W
Driver option	Integral control gear for On/Off (-ND), DALI (-DA). Remote driver is included for 1-10V (-DI)

Driver	Constant current (CC)
Input voltage	220-240 V 50/60 Hz
Optic	0
Optic value	Opal
CCT / CRI	3000K CRI80, 4000K CRI80
Dimming type	On/Off, 1-10V, DALI

Product colours	Black, White, Matt Silver, Concrete - Urban, Softscape - Urban, Stone - Urban, Corten - Urban, Oak - Woodland, Walnut - Woodland, Pine - Woodland
Weight	3.2 kg
Operating temperature	-20 °C to 40 °C
Variants (On/Off, 1-10V, DALI)	Compatible with EN/ IEC 60598-2-22: Suitable for emergency installations as central supply, non-maintained (Z0)

OUL-80821

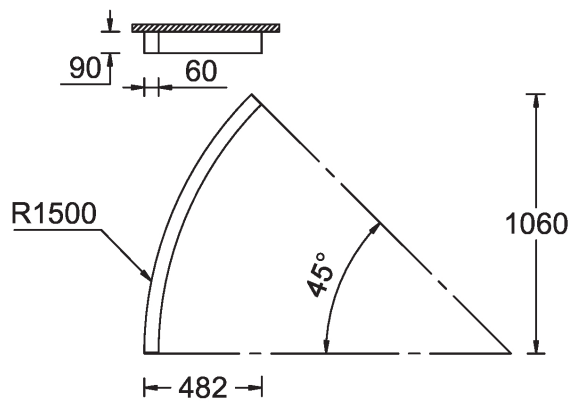

OULU 7 (OUL-80821)**Accessory**

Ceiling-mounting bracket (40 mm profile)
A81381



Continuous-coupler bracket
A81781



Wireless bluetooth converter
A90291



Xpress wireless switch
A90591



DALI Control System
Control-DALI