

**NYBRO 25 (NYB-81022-PE)**



**Product description**

Down (Optic) & Up (Optic 2nd) - Y120° - 40x95 mm - 502 mm



microPrim™

**Luminaire Structure**

- Die-cast aluminium end-caps and extruded aluminium profile with powder coating
- Passive thermal management
- Stainless steel fasteners in grade 304 with zinc flake coating (ZFC)
- PMMA diffuser with Opal (UGR <19) and micro prismatic (UGR <13) options for better glare control
- Integral control gear
- Cut the connection angle according to the shape complete with electrical wires in white for mounting
- Up and down light distribution options
- Wireless control available through Bluetooth connection
- Daylight and occupancy sensor options

**Optic**

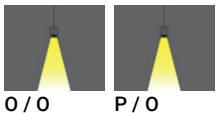

**Product colour**



**Special finishes upon request**



**NYBRO 25 (NYB-81022-PE)**

**Technical information**

<b>Material</b>	Aluminium
<b>Light source</b>	120 & 108 LED
<b>Power</b>	42 W
<b>Lumen</b>	3431 - 3785 lm
<b>Efficacy</b>	82 - 90 lm/W
<b>Driver option</b>	Integral control gear
<b>Driver</b>	Constant current (CC)
<b>Input voltage</b>	220-240 V 50/60 Hz

<b>Optic</b>	O, P
<b>Optic value</b>	Opal, Micro-prismatic
<b>Optic (2nd)</b>	O
<b>Optic (2nd) value</b>	Opal
<b>CCT / CRI</b>	3000K CRI80, 4000K CRI80
<b>Dimming type</b>	On/Off, DALI
<b>Product colours</b>	Black, White, Matt Silver, Concrete - Urban, Softscape - Urban, Stone - Urban, Corten - Urban, Oak - Woodland, Walnut - Woodland, Pine - Woodland
<b>Weight</b>	3.7 kg

<b>Operating temperature</b>	-20 °C to 40 °C
<b>MacAdam Ellipse</b>	3 SDCM
<b>Lifetime L90B10 (hours)</b>	> 23,000
<b>Lifetime L80B10 (hours)</b>	> 45,000
<b>Lifetime L80B50 (hours)</b>	> 50,000
<b>Variants (On/Off, DALI)</b>	Compatible with EN/ IEC 60598-2-22: Suitable for emergency installations as central supply, non-maintained (Z0)

NYB-81022-PE

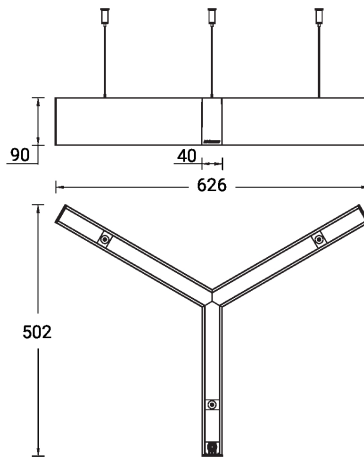

**NYBRO 25 (NYB-81022-PE)****Accessory**

---



---

Continuous-coupler bracket  
(60/70 mm Down & 60 mm  
Down & Up profile)  
**A81581**

---



---

Supply cable surface mounting  
box  
**A80981**

---



---

DALI Control System  
**Control-DALI**

---