

PITTSFIELD 4 (PIT-90011)



Product description

Down - 1060 mm



microPrim™

Luminaire Structure

- Extruded aluminium bended profile with powder coating
- Passive thermal management
- Stainless steel fasteners in grade 304 with zinc flake coating (ZFC)
- PMMA diffuser with Opal (UGR <19) and micro prismatic (UGR <13) options for better glare control

- Integral control gear
- Stainless steel, adjustable, suspension (1.5 m) complete with electrical wires in white for mounting
- Up and down light distribution options
- Wireless control available through Bluetooth connection

- Daylight and occupancy sensor options
- Emergency module (1 or 3 hours) is available upon request with 3 options (BASIC, SELF-TEST, PRO-DALI)

Optic

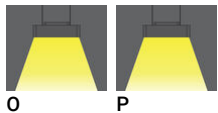

Product colour



01 - Black (RAL 9011) 03 - White (RAL 9003) 05 - Matt Silver (RAL 9006)

Special finishes upon request



SU01 - Concrete - Urban SU02 - Softscape - Urban SU03 - Stone - Urban SU04 - Corten - Urban



SW01 - Oak - Woodland SW02 - Walnut - Woodland SW03 - Pine - Woodland

PITTSFIELD 4 (PIT-90011)

Technical information

Material	Aluminium	Input voltage	220-240 V 50/60 Hz	Operating temperature	-20 °C to 40 °C
Light source	432 LED	Optic	O, P	MacAdam Ellipse	3 SDCM
Power	27 W	Optic value	Opal, Micro-prismatic	Lifetime L90B10 (hours)	> 23,000
Lumen	2915 - 3336 lm	CCT / CRI	3000K CRI80, 4000K CRI80	Lifetime L80B10 (hours)	> 45,000
Efficacy	108 - 124 lm/W	Dimming type	On/Off, 1-10V, DALI	Lifetime L80B50 (hours)	> 50,000
Driver option	Integral control gear	Product colours	Black, White, Matt Silver, Concrete - Urban, Softscape - Urban, Stone - Urban, Corten - Urban, Oak - Woodland, Walnut - Woodland, Pine - Woodland	Variants (On/Off, 1-10V, DALI)	Compatible with EN/ IEC 60598-2-22: Suitable for emergency installations as central supply, non-maintained (Z0)
Driver	Constant current (CC)				
		Weight	5.2 kg		

PIT-90011

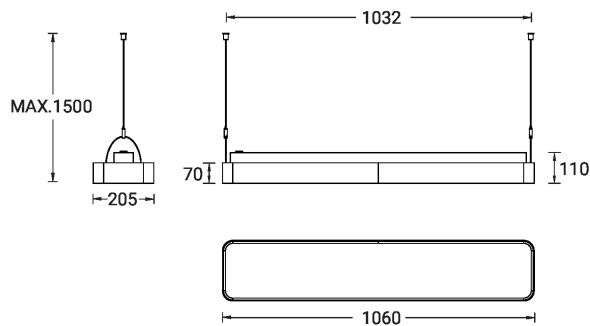

PITTSFIELD 4 (PIT-90011)**Accessory**

Supply cable surface mounting
box
A80981



Wireless bluetooth converter
A90291



Xpress wireless switch
A90591

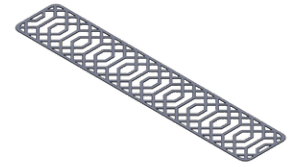

Decorative pattern - Type A for
PITTSFIELD 1060 mm
A92021

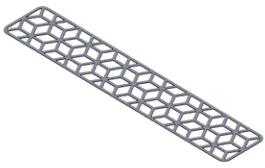

Decorative pattern - Type B for
PITTSFIELD 1060 mm
A93421

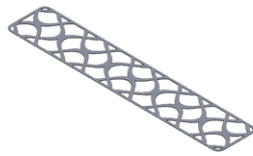

Decorative pattern - Type C for
PITTSFIELD 1060 mm
A94821



Emergency module - 250V -
BASIC
EM250V-BA

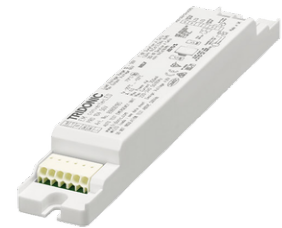

Emergency module - 250V -
PRO-DALI
EM250V-DA

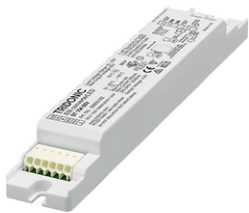

Emergency module - 250V -
SELF-TEST
EM250V-ST



DALI Control System
Control-DALI