

ABACUS 4 (AB-10001)



Product description

260x75 mm - 500 mm - 1 side



microPrim™

Luminaire Structure

- Die-cast aluminium housing
- Extruded aluminium column
- Pre-treated before powder coating ensuring high corrosion resistance
- Single cable entry
- One IP68 connector supplied with 0.2 m of 3x1.0 sqmm outdoor cable
- Stainless steel fasteners in grade 304 with zinc flake coating (ZFC)
- Durable silicone rubber gasket
- Frosted glass diffuser
- Integral control gear

Optic



G

Product colour



Special finishes upon request



ABACUS 4 (AB-10001)

Technical information

Material	Aluminium
Light source	30 LED
Power	11 W
Lumen	765 - 783 lm
Efficacy	70 - 71 lm/W
Driver option	Integral control gear
Driver	Constant current (CC)
Input voltage	220-240 V 50/60 Hz
Optic	G

Optic value	102°x 70°
CCT / CRI	3000K CRI80, 4000K CRI80
Bug	B1-U2-G1
ULR	2%
ULOR	2%
CIE flux code n°3	96
Dimming type	On/Off
Product colours	Black, Dark Grey, White, Matt Silver, Bronze, Concrete - Urban, Softscape - Urban, Stone - Urban, Corten - Urban, Oak - Woodland, Walnut - Woodland, Pine - Woodland
Weight	5.7 kg

Operating temperature	-20 °C to 40 °C
Cable	One IP68 connector supplied with 0.2 m of 3x1.0 sqmm outdoor cable
Through wiring	Single cable entry
Lens / Reflector / Optic	Frosted glass diffuser
MacAdam Ellipse	3 SDCM
Lifetime L90B10 (hours)	> 23,000
Lifetime L80B10 (hours)	> 45,000
Lifetime L80B50 (hours)	> 49,000
Variants (On/Off)	Compatible with EN/ IEC 60598-2-22: Suitable for emergency installations as central supply, non-maintained (Z0)

AB-10001

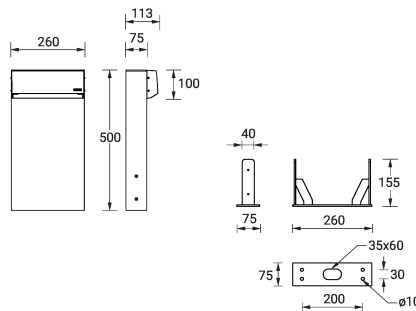

ABACUS 4 (AB-10001)**Accessory**

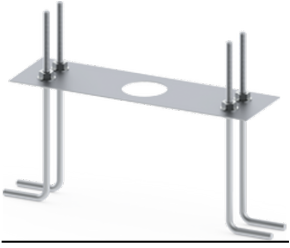

Anchor bolt
A12091
