

POWERVISION 1 (PW19-GP028)



Luminaire Structure

- Extruded aluminium housing
- Pre-treated before powder coating ensuring high corrosion resistance
- Thermal heat dissipation body
- Single cable entry, through wiring upon request
- One IP68 connector supplied with 0.2 m of 3x1.0 sqmm outdoor cable
- Stainless steel fasteners in grade 304 with zinc flake coating (ZFC)
- Durable silicone rubber gasket
- Clear toughened glass
- Integral control gear

Optic

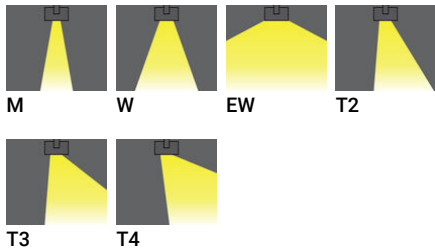

Product colour

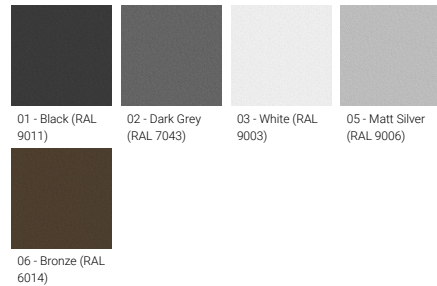

Special finishes upon request

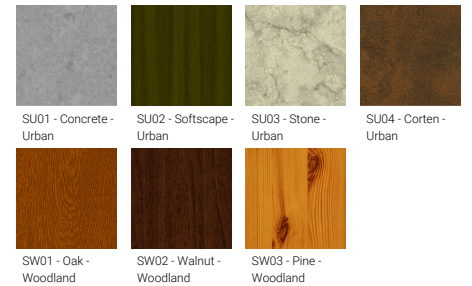

POWERVISION 1 (PW19-GP028)

Technical information

Material	Aluminium
Light source	24 LED
Power	27 W
Lumen	3052 - 3523 lm
Efficacy	113 - 130 lm/W
Driver option	Integral control gear
Driver	Constant current (CC)
Input voltage	220-240 V 50/60 Hz

Optic	M, W, EW, T2, T3, T4
Optic value	30°, 53°, 124°, 142°x53°, 141°x69°, 99°x79°
CCT / CRI	3000K CRI80, 4000K CRI80
Dimming type	On/Off, 1-10V, DALI
Product colours	Black, Dark Grey, White, Matt Silver, Bronze, Concrete - Urban, Softscape - Urban, Stone - Urban, Corten - Urban, Oak - Woodland, Walnut - Woodland, Pine - Woodland
Weight	9.0 kg
Operating temperature	-20 °C to 40 °C
Cable	One IP68 connector supplied with 0.2 m of 3x1.0 sqmm outdoor cable

Through wiring	Single cable entry, through wiring upon request
Lens / Reflector / Optic	Clear toughened glass
MacAdam Ellipse	3 SDCM
Lifetime L90B10 (hours)	> 90,000
Lifetime L80B10 (hours)	> 90,000
Lifetime L80B50 (hours)	> 90,000
Variants (On/Off, 1-10V, DALI)	Compatible with EN/ IEC 60598-2-22: Suitable for emergency installations as central supply, non-maintained (Z0)

PW19-GP028

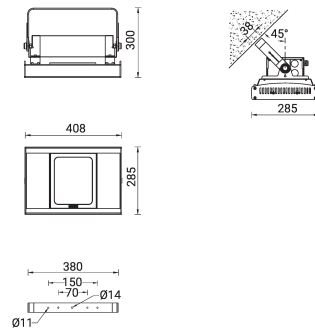

POWERVISION 1 (PW19-GP028)

Accessory



DALI Control System
Control-DALI
