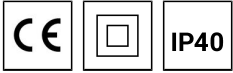
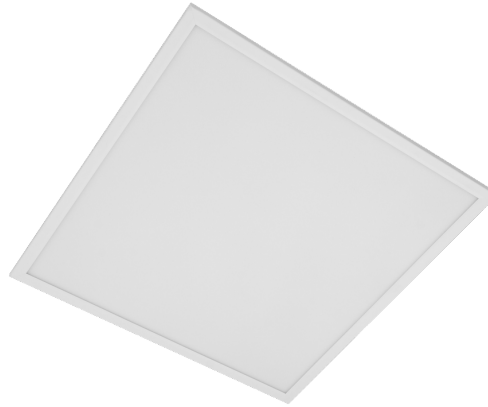
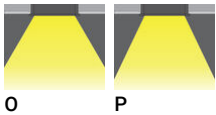
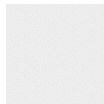

VIENNA 1 (VIE-80003)**Product description**

600x600 mm

**Luminaire Structure**

- Formed sheet steel body with powder coating
- White painted metal sheet
- UV & flame resistant, chemical & salt stable PVC
- Stainless steel fasteners in grade 304 with zinc flake coating (ZFC)
- PMMA diffuser with Opal (UGR <19) and micro prismatic (UGR <13) options for better glare control
- Integral control gear
- Recessed and surface mounted options
- Accessories: Aluminium frame for surface installation & Aluminium frame for recessed installation of fitting into gypsum plasterboard

Optic**Product colour**

03 - White (RAL 9003)

VIENNA 1 (VIE-80003)

Technical information

Material	Aluminium	Driver option	Integral control gear	CCT / CRI	3000K CRI90, 4000K CRI90
Light source	2 x 91 LED	Driver	Constant current (CC)	Dimming type	On/Off, DALI
Power	49 W	Input voltage	220-240 V 50/60 Hz	Product colours	White
Lumen	5300 - 5400 lm	Optic	O, P	Weight	5.0 kg
Efficacy	108 - 110 lm/W	Optic value	Opal, Micro-prismatic	Operating temperature	-20 °C to 40 °C

VIE-80003

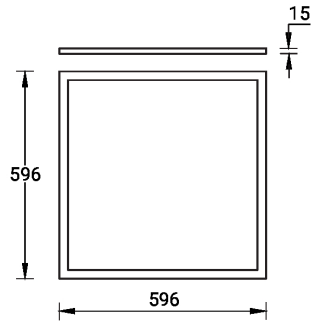

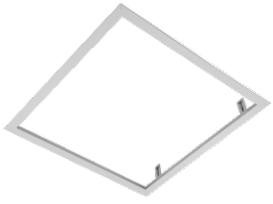
VIENNA 1 (VIE-80003)**Accessory**

Frame for recessed installation
of fittings into gypsum
plasterboard ceiling SQUARE
(White)
A83081

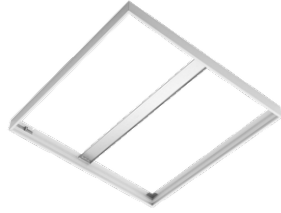

Frame for surface installation
SQUARE (White)
A83281



Wireless bluetooth converter
A90291



Xpress wireless switch
A90591



DALI Control System
Control-DALI