

GAVLE 6 (GAV-90232)



Product description

Down - 100x90 mm - 2000 mm - Tunable White



microPrim™

Luminaire Structure

- Extruded aluminium bended profile with powder coating
- Passive thermal management
- Stainless steel fasteners in grade 304 with zinc flake coating (ZFC)
- Opal PMMA diffuser (UGR <19) for glare control

- Integral control gear
- Stainless steel, adjustable, suspension (1.5 m) complete with electrical wires in white for mounting
- Up and down light distribution options
- Wireless control available through Bluetooth connection

- Daylight and occupancy sensor options

Optic



0

Product colour



01 - Black (RAL 9011) 03 - White (RAL 9003) 05 - Matt Silver (RAL 9006)

Special finishes upon request



SU01 - Concrete - Urban SU02 - Softscape - Urban SU03 - Stone - Urban SU04 - Corten - Urban



SW01 - Oak - Woodland SW02 - Walnut - Woodland SW03 - Pine - Woodland

GAVLE 6 (GAV-90232)

Technical information

| | |
|----------------------|-----------------------|
| Material | Aluminium |
| Light source | 2688 LED |
| Power | 173 W |
| Lumen | 20911 lm |
| Efficacy | 121 lm/W |
| Driver option | Integral control gear |

| | |
|----------------------|-----------------------|
| Driver | Constant current (CC) |
| Input voltage | 220-240 V 50/60 Hz |
| Optic | 0 |
| Optic value | 102° |
| CCT / CRI | TW (2700K - 6500K) |
| Dimming type | DALI |

| | |
|------------------------------|---|
| Product colours | Black, White, Matt Silver, Concrete - Urban, Softscape - Urban, Stone - Urban, Corten - Urban, Oak - Woodland, Walnut - Woodland, Pine - Woodland |
| Weight | 19.3 kg |
| Operating temperature | -20 °C to 40 °C |
| Variants (DALI) | Compatible with EN/ IEC 60598-2-22: Suitable for emergency installations as central supply, non-maintained (Z0) |

GAV-90232

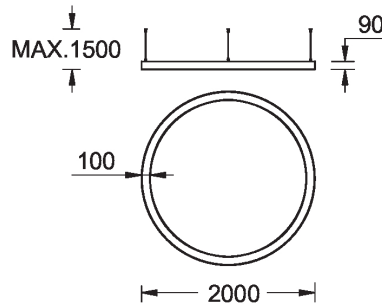

GAVLE 6 (GAV-90232)**Accessory**

Supply cable surface mounting
box
A80981



Wireless bluetooth converter
A90291



Xpress wireless switch
A90591



DALI Control System
Control-DALI