

OULU 12 (OUL-90621)



Product description

Down - 22.5° - R2500



microPrim™

Luminaire Structure

- Extruded aluminium bended profile with powder coating
- Passive thermal management
- Stainless steel fasteners in grade 304 with zinc flake coating (ZFC)
- Opal PMMA diffuser (UGR <19) for glare control
- Integral control gear for On/Off (-ND), DALI (-DA). Remote driver is included for 1-10V (-DI)
- Stainless steel, adjustable, suspension (1.5 m) complete with electrical wires in white for mounting
- Up and down light distribution options
- Wireless control available through Bluetooth connection
- Daylight and occupancy sensor options

Optic



0

Product colour

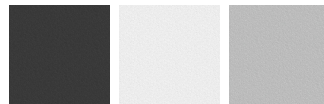

01 - Black (RAL 9011) 03 - White (RAL 9003) 05 - Matt Silver (RAL 9006)

Special finishes upon request

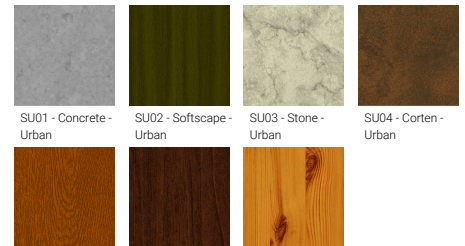

SU01 - Concrete - Urban SU02 - Softscape - Urban SU03 - Stone - Urban SU04 - Corten - Urban
 SW01 - Oak - Woodland SW02 - Walnut - Woodland SW03 - Pine - Woodland

OULU 12 (OUL-90621)

Technical information

Material	Aluminium
Light source	120 LED
Power	16 W
Lumen	1492 - 1558 lm
Efficacy	93 - 97 lm/W
Driver option	Integral control gear for On/Off (-ND), DALI (-DA). Remote driver is included for 1-10V (-DI)

Driver	Constant current (CC)
Input voltage	220-240 V 50/60 Hz
Optic	0
Optic value	Opal
CCT / CRI	3000K CRI80, 4000K CRI80
Dimming type	On/Off, 1-10V, DALI

Product colours	Black, White, Matt Silver, Concrete - Urban, Softscape - Urban, Stone - Urban, Corten - Urban, Oak - Woodland, Walnut - Woodland, Pine - Woodland
Weight	2.9 kg
Operating temperature	-20 °C to 40 °C
Variants (On/Off, 1-10V, DALI)	Compatible with EN/ IEC 60598-2-22: Suitable for emergency installations as central supply, non-maintained (Z0)

OUL-90621

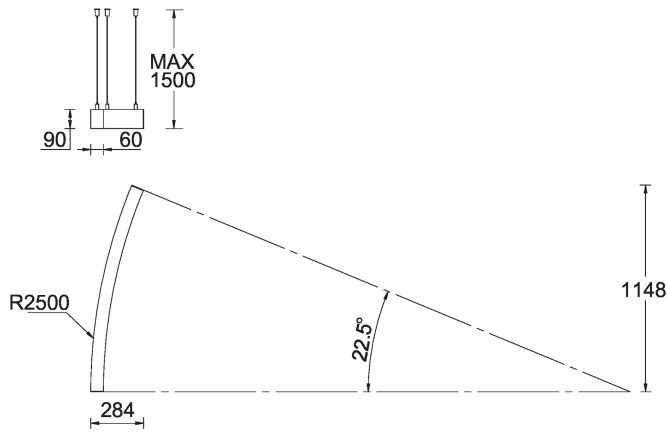

OULU 12 (OUL-90621)**Accessory**



Continuous-coupler bracket
A81781



Supply cable surface mounting
box
A80981



Wireless bluetooth converter
A90291



Xpress wireless switch
A90591
