

For Installation of NEON CLASSIC Continuous LED Solution IP67 (24VDC)

Product drawing (dimensions)

IP67

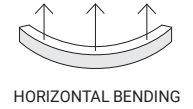
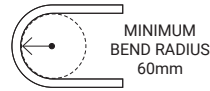
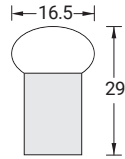
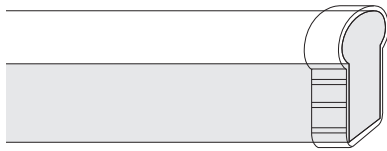

NEON CLASSIC | ELECTRICAL AND PHYSICAL INSTALLTION GUIDE

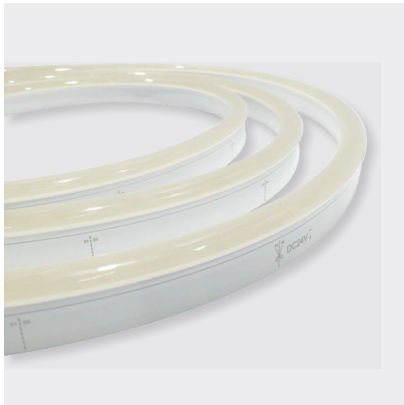

COLOUR	NEON SERIES	VARIANT CODE
WARM WHITE 3000K +/- 175K	NEON 7	ITNO1230001067-CL-HB
NATURAL WHITE 4000K +/- 275K	NEON 7	ITNO1240001067-CL-HB
2500 - 5000K TUNEABLE WHITE	NEON 8	ITNO12TUW01067-CL-HB
RED 615-625mm	NEON 9	ITNO12R0001067-CL-HB
GREEN 520-530mm	NEON 9	ITNO12G0001067-CL-HB
BLUE 465-475mm	NEON 9	ITNO12B0001067-CL-HB
YELLOW 580mm	NEON 9	ITNO12Y0001067-CL-HB
RGB	NEON 10	ITNO12RGB01067-CL-HB
RGBW	NEON 11	ITNO15RGBW0567-CL-HB
RGB DYNAMIC	NEON 19	ITNO12RGBC1067-CL-HB

ELECTRICAL & OPTICAL DATA VARIANCE +/- 10%
SOLD BY THE METRE
IES FILES AVAILABLE

Please note drawings are an installation guide only. Each LED tape application may have variable factors. Cable size may need to be specified to limit the voltage drop throughout the circuit.

Actual product characteristics may vary. Ligman Lighting reserves the right to improve, modify or update the product designs without prior notice.

ALWAYS UNCOIL BEFORE USE

- LIGMAN standard products are supplied with the control gear 24VDC
The control gear for other voltages and frequencies is available upon request, please consult us for more details.
- LIGMAN luminaires are designed to conform IEC 60598 2-2 standard.

Technical amendments and modifications techniques reserved.

Ligman Lighting

THAILAND
LIGMAN Lighting Co.,Ltd.
17/2 Moo 4, Monthong, Bang Nam Prio,
24150 Chachoengsao - Thailand
info@ligman.com

BENDING PARAMETERS



NEON CLASSIC CAN BE CURVED AS SHOWN BELOW

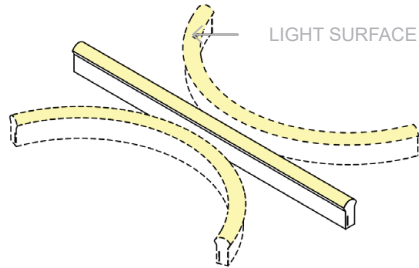

DO NOT TWIST THE LIGHT OR BEND AGAINST THE LIGHT SURFACE

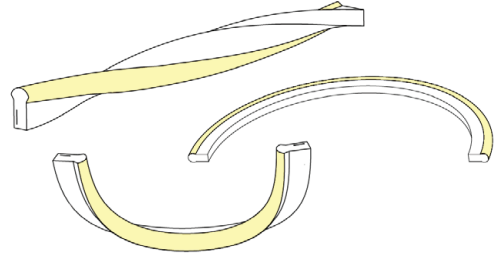

– Avoid bending LED Neon within the first unit (*units are clearly marked with dashed lines on the sides of the product*)

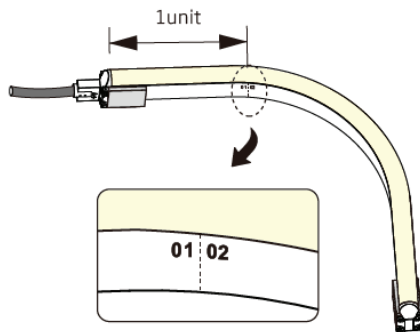

– LED Neon can be bent up to the defined “minimum bend radius” (60mm for Neon Classic)

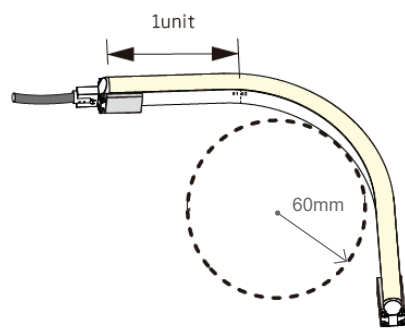

WIRING DIAGRAMS

WHITE / SINGLE COLOUR

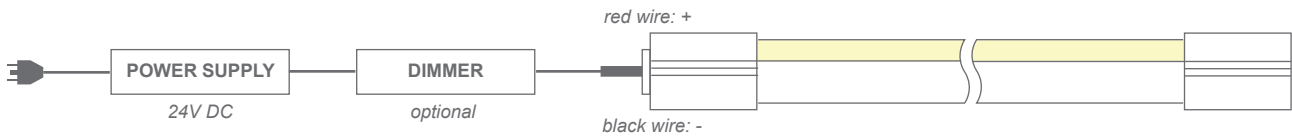

TUNEABLE WHITE

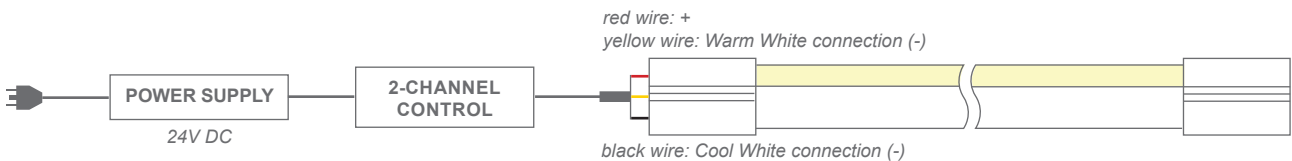

RGB

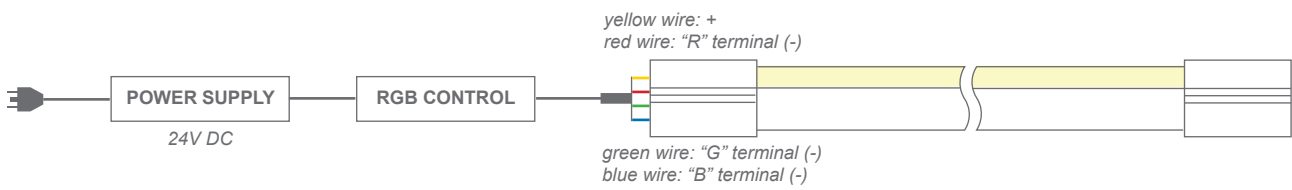

RGBW

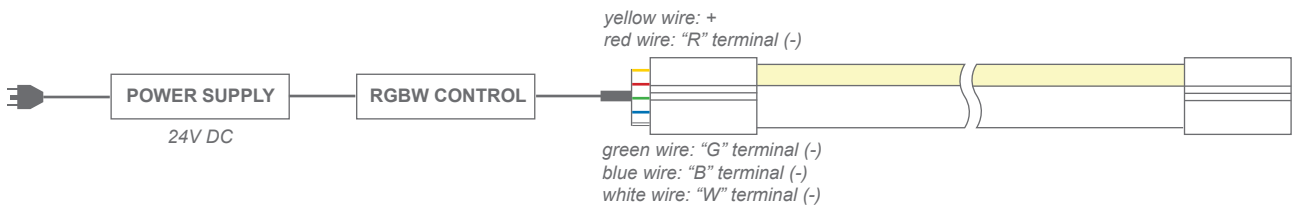

DYNAMIC RGB 'CHASING' / RGBW 'CHASING'

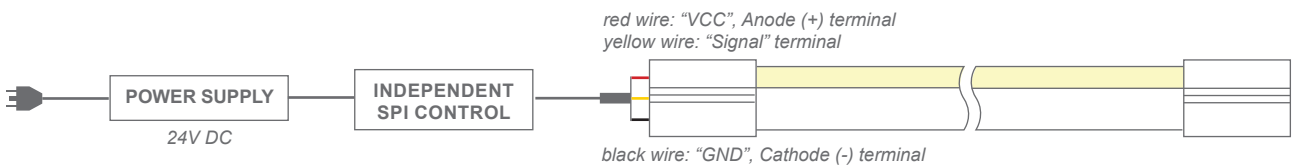

DMX OPTION AVAILABLE

- LED Neon must always be used in conjunction with a certified Bright Light 24V DC power supply.
- Check the polarity of the connector before inserting the front connector and switching on the mains power.
- To minimise voltage drop and ensure consistent light output, position the power supply near to the power feed end of the LED Neon, and keep the line as short as possible
- Ensure your maximum run per power feed adheres to the guidelines; see specification sheet.
- Ensure to add 20% buffer when selecting a power supply
- Before making any cuts, installation, maintenance, or connection, be sure the mains power is disconnected.
- If essential; cut and connect LED Neon correctly. Any incorrect operation can cause damage.
- All connector joints must be connected correctly to achieve connector IP rating.

PROFILE INSTALLATION REQUIREMENTS

ACCESSORY

A80104-001
SELF-LOCKING ALUMINIUM V2 PROFILE 2m

A80105-001
SELF-LOCKING ALUMINIUM V2 MOUNTING CLIP 35mm

A80106-001
PLASTIC PROFILE 2m

A80106-002
PLASTIC PROFILE 1m

REFER TO
MOUNTING ACCESSORIES PDF
FOR PROFILE DETAILS
& DIMENSIONS

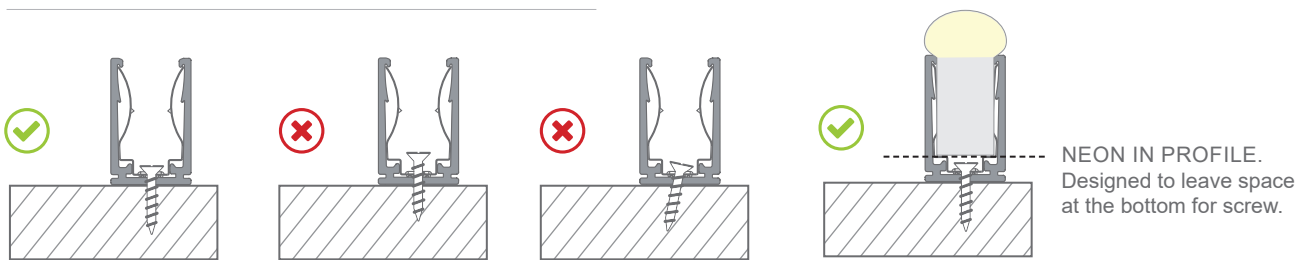

PROFILE MOUNTING: Install the screw ensuring head is flush or lower than the profile groove and into surface straight

ACCESSORY

A80107-001
CURVE STAINLESS STEEL PROFILE 900MM
MULTIPLE FIXING LOCATIONS

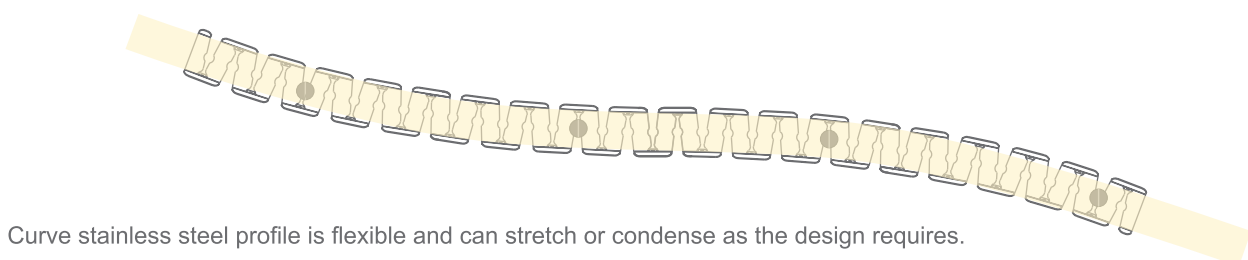
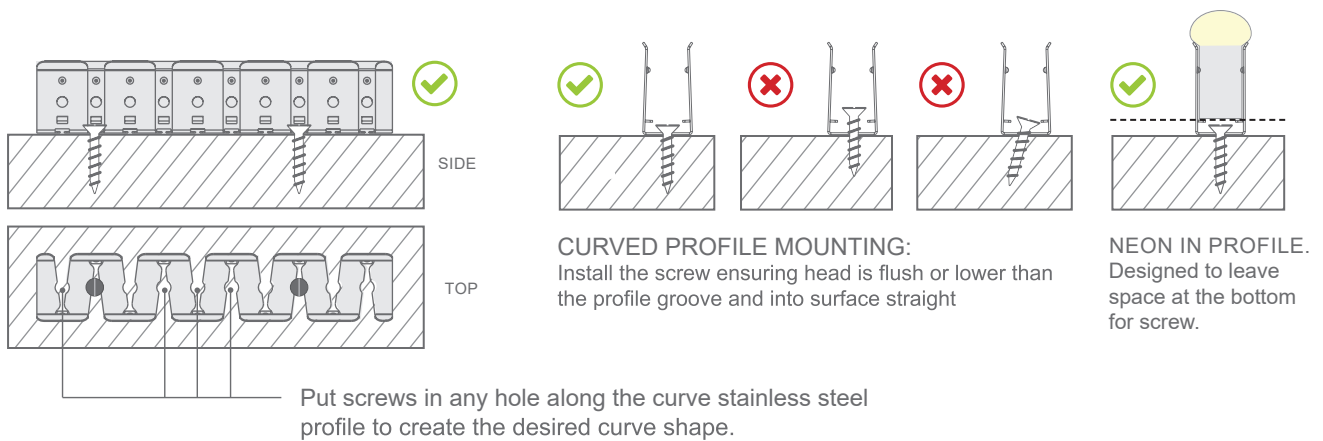

Curve stainless steel profile is flexible and can stretch or condense as the design requires.

PROFILE INSTALLATION REQUIREMENTS

>> FOR SLEEVE / SNAP / DUAL INJECTION MOULDING CONNECTORS

- ✔ - Ensure the supply cord is not subject to mechanical stress
- Keep 10–20mm distance between the end of the profile and the end mounting piece

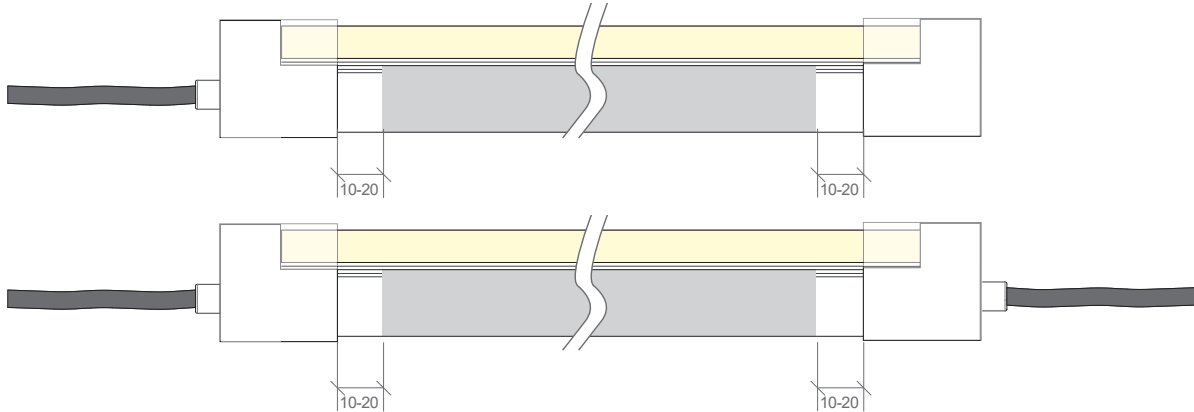

- The bend angle should be less than 15 degrees when installing LED Neon into the profile by hand

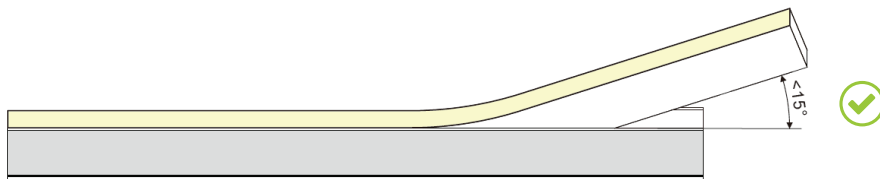

- ✘ - Avoid placing mechanical stress on the front connector cable
- Do not curl or bend the front connector cable with excessive force

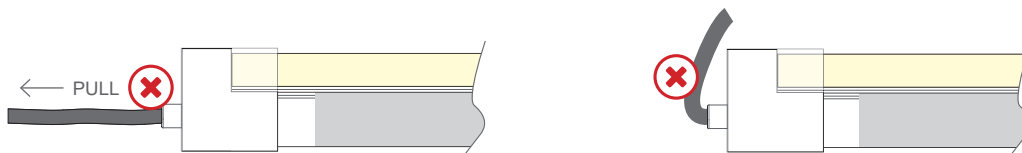

- Avoid installing the profile less than 10mm from the end mounting piece

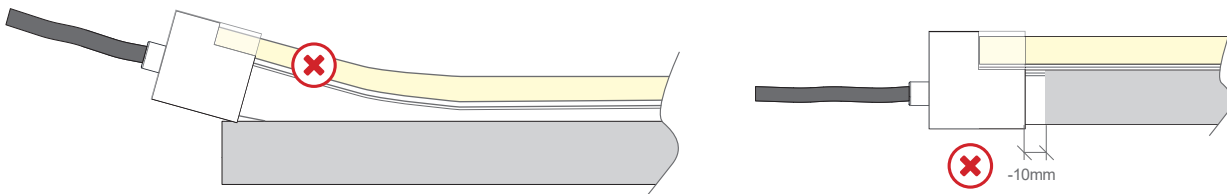

- Install the LED Neon into the profile in one direction, don't let it bow in the middle

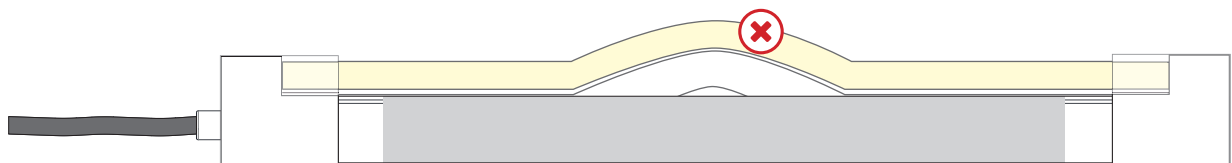

PROFILE INSTALLATION REQUIREMENTS >> FOR SLIMLINE INJECTION MOULDING CONNECTOR

TOP END FEED

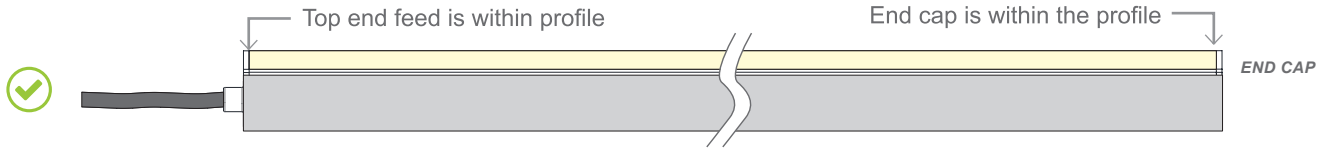

- Top End Feed (Slimline injection moulding only) & end cap are both fitted within the profile

BOTTOM FEED / SIDE FEED

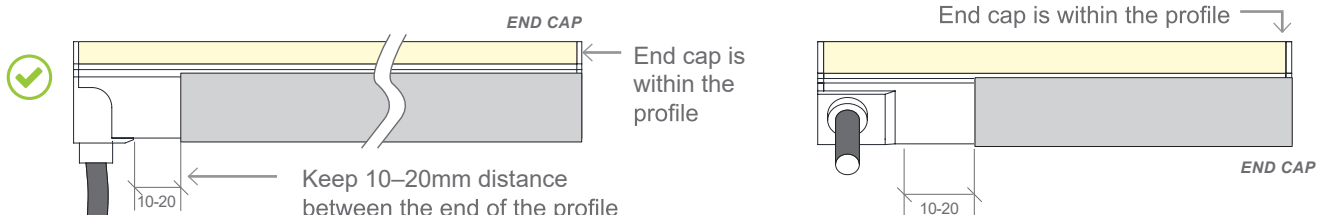

- Bottom feed / side feed are keep outside the profile with 10-20mm space
- End cap is within the profile

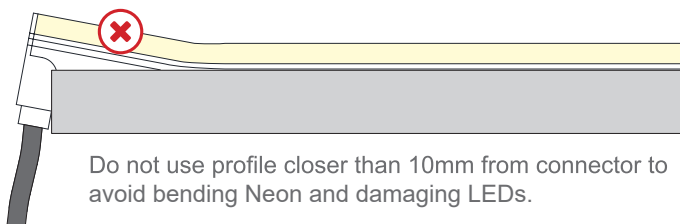

- Avoid placing mechanical stress on the connector cable
- Do not curl or bend the connector cable with excessive force

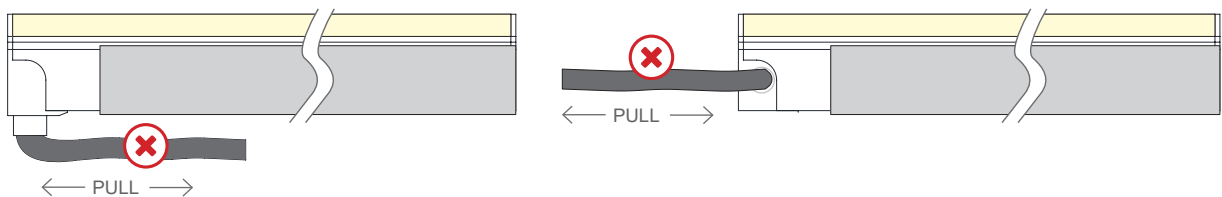

MIDDLE FEED

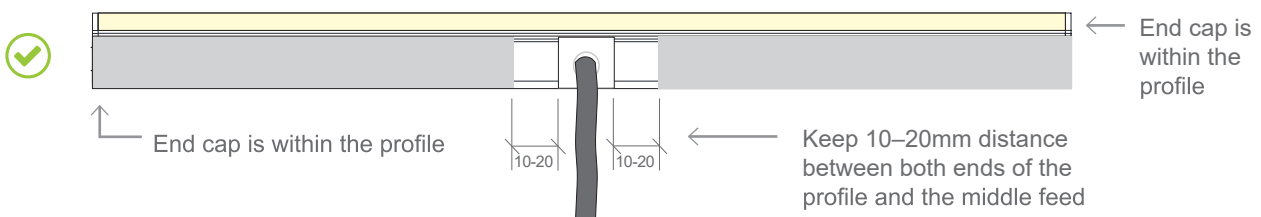

SNAP CONNECTIONS - IP67

SUITABLE FOR OUTDOOR APPLICATIONS
 MUST BE FITTED CORRECTLY FOR IP67 RATING
 FEED CONNECTORS SUPPLIED AS 1M CABLE.
STANDARD INSTALLATION WITH SINGLE POWER FEED:
 FEED 01 + END CAP 02
DOUBLE POWER FEED: FEED 01 + FEED 02



TOP END FEED



END CAP



FLEXIBLE CONNECTOR

	01	02		
WHITE	A80083-003	A80083-004		A80085-002
TUNEABLE	A80083-005	A80083-006		A80085-003
SINGLE COLOUR	A80083-003	A80083-004	A80084-002	A80085-002
RGB	A80083-007	A80083-008		A80085-004
RGB CHASING	A80083-009	A80083-010		A80085-005
RGBW				

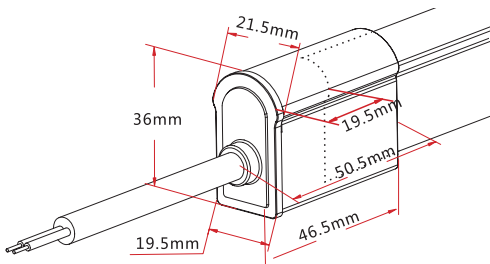

TOP END FEED

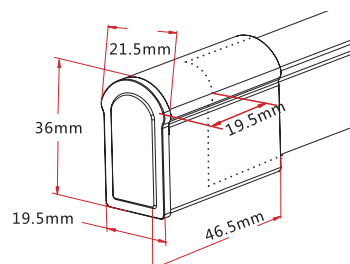

END CAP

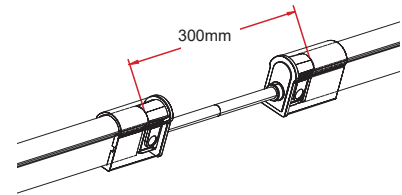

FLEXIBLE CONNECTOR

SLIMLINE INJECTION MOULDING CONNECTIONS - IP67

REQUIRES FITTING AT FACTORY. LEAD TIMES APPLY
 SUITABLE FOR OUTDOOR APPLICATIONS
 FEED CONNECTORS SUPPLIED AS 1M CABLE

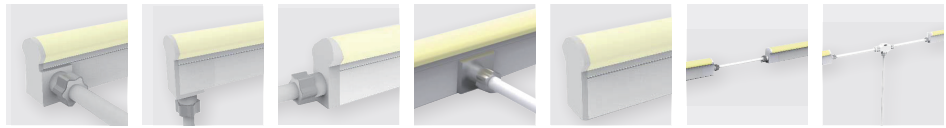

SIDE FEED BOTTOM FEED TOP END FEED MIDDLE FEED END CAP FLEXIBLE CONNECTOR T FEED

WHITE / TUNEABLE / SINGLE COLOUR / RGB

A80086 A80087 A80088 A80089 A80090 A80091 A80092

RGB CHASING / RGBW

A80086 A80087 A80088 - A80090 A80091 A80092

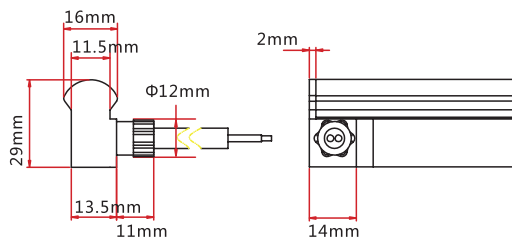

SIDE FEED

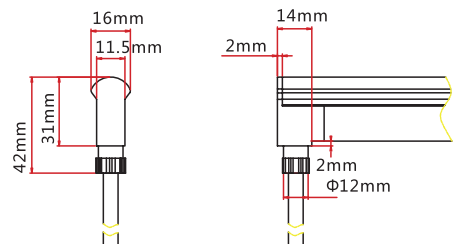

BOTTOM FEED

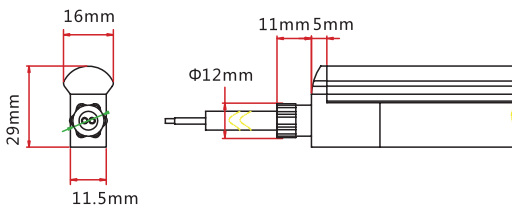

TOP END FEED

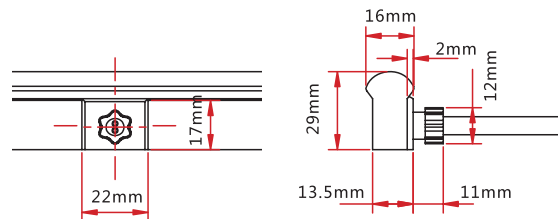

MIDDLE FEED

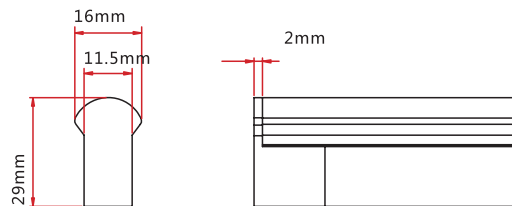

END CAP

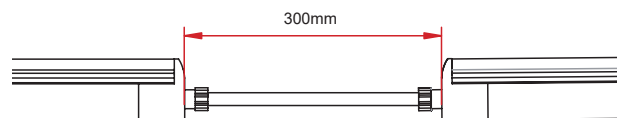

FLEXIBLE CONNECTOR

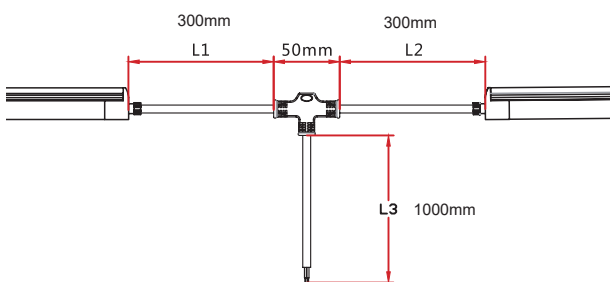

T-FEED

CAPPED DUAL INJECTION MOULDING - IP68

REQUIRES FITTING AT FACTORY. LEAD TIMES APPLY

SUITABLE FOR OUTDOOR APPLICATIONS

FEED CONNECTORS SUPPLIED AS 1M CABLE

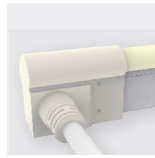

SIDE FEED

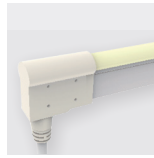

BOTTOM FEED

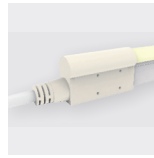

TOP END FEED

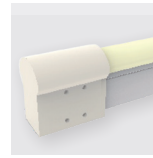

END CAP

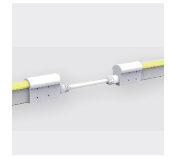

FLEXIBLE CONNECTOR

WHITE / TUNEABLE / SINGLE COLOUR /
RGB / RGB CHASING / RGBW

A80093

A80094

A80095

A80096

A80097

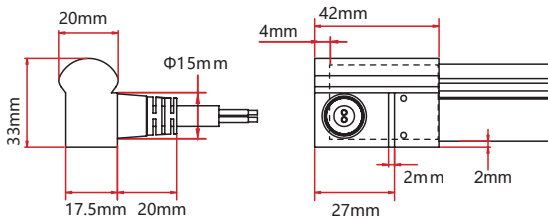

SIDE FEED

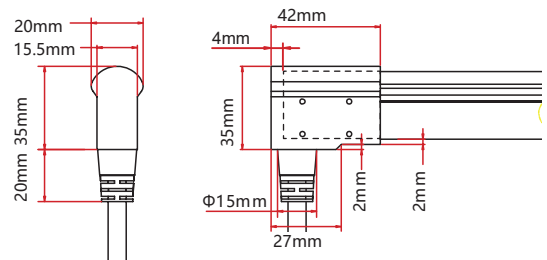

BOTTOM FEED

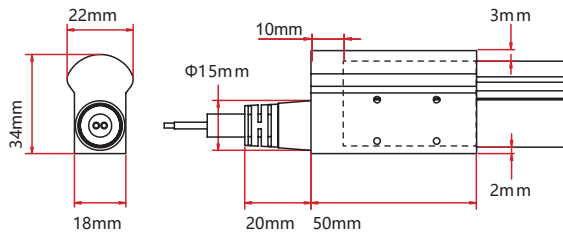

TOP END FEED

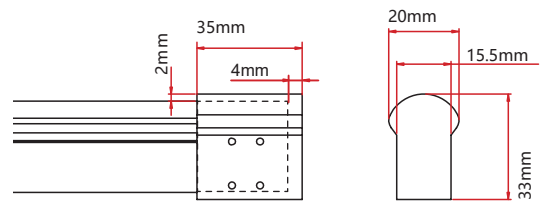

END CAP

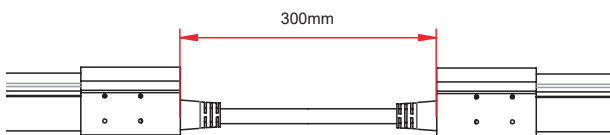

FLEXIBLE CONNECTOR

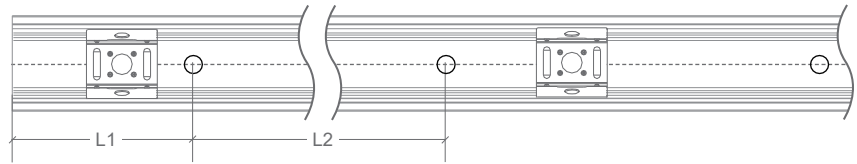

CODE	ACCESSORY	L1	L2	HOLE DIMENSIONS	HOLE NUMBER	CLIP NUMBER
A80104-001	SELF-LOCKING ALUMINIUM V2 PROFILE 2M	100mm	200mm	Ø3.5mm	10	9
A80105-001	SELF-LOCKING ALUMINIUM V2 MOUNTING CLIP 35MM	5mm	25mm	Ø3.5mm	2	1
A80106-001	PLASTIC PROFILE 2M	100mm	200mm	Ø3.5mm	10	-
A80106-002	PLASTIC PROFILE 1M	100mm	200mm	Ø3.5mm	5	-
A80107-001	CURVE STAINLESS STEEL PROFILE 900MM <i>MULTIPLE FIXING LOCATIONS</i>	-	-	-	-	-

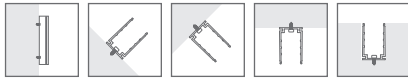
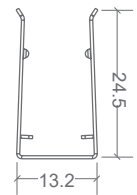
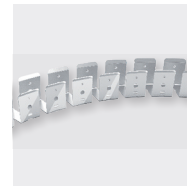
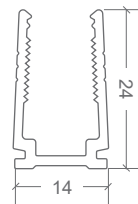
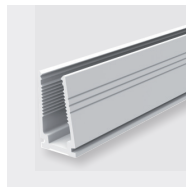
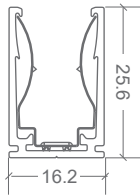
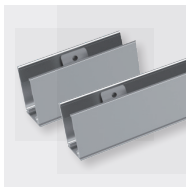

SELF-LOCKING ALUMINIUM
V2 PROFILE 2M / MOUNTING CLIP

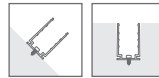

PLASTIC PROFILE

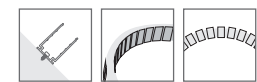
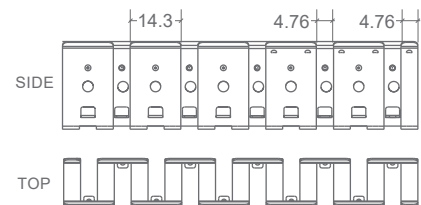

CURVE STAINLESS STEEL
PROFILE 900MM