

**LIGHTWAVE 2 (LW-10874)**



**Product description**

Ø160 - 870 mm - Straight



**Luminaire Structure**

- Die-cast aluminium housing
- Extruded aluminium column
- Pre-treated before powder coating ensuring high corrosion resistance
- Single cable entry
- One IP68 connector supplied with 0.2 m of 3x1.0 sqmm outdoor cable
- Stainless steel fasteners in grade 304 with zinc flake coating (ZFC)
- Durable silicone rubber gasket
- Clear UV-stabilised polycarbonate diffuser
- Anodised, high-purity aluminium reflector
- Integral control gear

**Optic**



G

**Product colour**

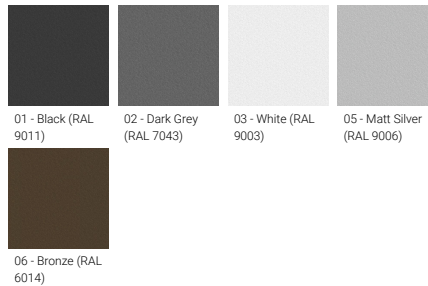

**Special finishes upon request**

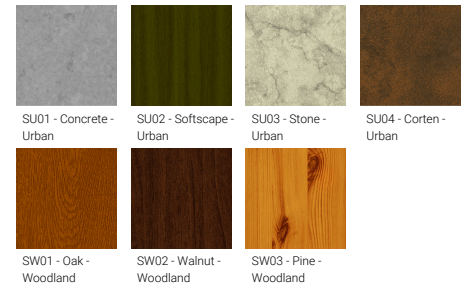

**LIGHTWAVE 2 (LW-10874)**

**Technical information**

<b>Material</b>	Aluminium
<b>Light source</b>	12 LED
<b>Power</b>	27 W
<b>Lumen</b>	448 - 475 lm
<b>Efficacy</b>	16 - 17 lm/W
<b>Driver option</b>	Integral control gear
<b>Driver</b>	Constant current (CC)
<b>Input voltage</b>	220-240 V 50/60 Hz

<b>Optic</b>	G
<b>Optic value</b>	180°
<b>CCT / CRI</b>	3000K CRI80, 4000K CRI80
<b>Bug</b>	B0-U3-G1
<b>ULR</b>	18%
<b>ULOR</b>	18%
<b>CIE flux code n°3</b>	62
<b>Dimming type</b>	On/Off, 1-10V, DALI

<b>Product colours</b>	Black, Dark Grey, White, Matt Silver, Bronze, Concrete - Urban, Softscape - Urban, Stone - Urban, Corten - Urban, Oak - Woodland, Walnut - Woodland, Pine - Woodland
<b>Weight</b>	7.5 kg
<b>Operating temperature</b>	-20 °C to 40 °C
<b>Cable</b>	One IP68 connector supplied with 0.2 m of 3x1.0 sqmm outdoor cable
<b>Through wiring</b>	Single cable entry
<b>Lens / Reflector / Optic</b>	Clear UV-stabilised polycarbonate diffuser, Anodised, high-purity aluminium reflector
<b>Variants (1-10V)</b>	Compatible with EN/ IEC 60598-2-22: Suitable for emergency installations as central supply, non-maintained (Z0)

LW-10874

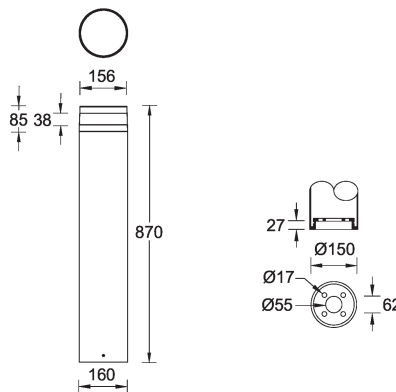

**LIGHTWAVE 2 (LW-10874)**

**Accessory**

---



Anchor bolt  
**A10291**



DALI Control System  
**Control-DALI**