

MARYS 6 (MY-80071)**Product description**

Ø203 mm

**Luminaire Structure**

- Die-cast aluminium housing with powder coating
- Die-cast aluminium heat sink with excellent thermal management
- Proprietary lens design for high LOR
- Remote driver (included)

Optic

N M W

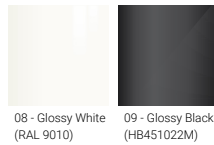
Product colour

08 - Glossy White (RAL 9010) 09 - Glossy Black (HB451022M)

MARYS 6 (MY-80071)

Technical information

Material	Aluminium
Light source	30 LED
Power	50 W
Lumen	4822 - 5696 lm
Efficacy	96 - 114 lm/W
Driver option	Remote driver (included)

Driver	Constant current (CC)
Input voltage	220-240 V 50/60 Hz
Optic	N, M, W
Optic value	13°, 27°, 37°
CCT / CRI	3000K CRI80, 4000K CRI80
Dimming type	On/Off, 1-10V, DALI

Product colours	Glossy White, Glossy Black
Weight	2.6 kg
Operating temperature	-20 °C to 40 °C
Variants (1-10V, DALI)	Compatible with EN/ IEC 60598-2-22: Suitable for emergency installations as central supply, non-maintained (Z0)

MY-80071

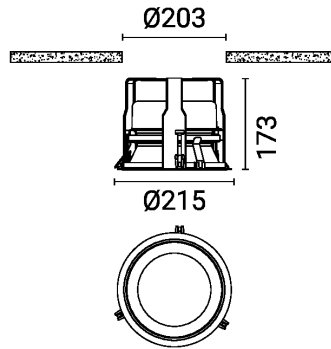

MARYS 6 (MY-80071)

Accessory



DALI Control System
Control-DALI
