

ARDEN 3 (ARD-80221)



Product description

Down - 480 mm



microPrim™

Luminaire Structure

- Extruded aluminium bended profile with powder coating
- Passive thermal management
- Stainless steel fasteners in grade 304 with zinc flake coating (ZFC)

- PMMA diffuser with Opal (UGR <19) and micro prismatic (UGR <13) options for better glare control
- Remote driver (included)
- Down light distribution only

- Wireless control available through Bluetooth connection
- Emergency module (1 or 3 hours) is available upon request with 3 options (BASIC, SELF-TEST, PRO-DALI)

Optic

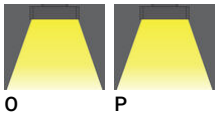

Product colour



Special finishes upon request

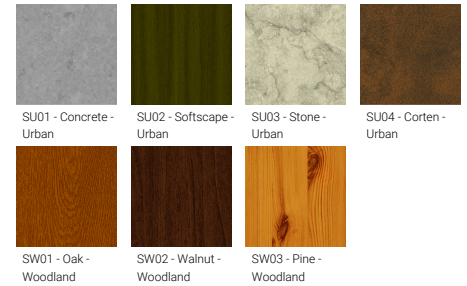

ARDEN 3 (ARD-80221)

Technical information

Material	Aluminium
Light source	480 LED
Power	41 W
Lumen	4805 - 5504 lm
Efficacy	117 - 134 lm/W
Driver option	Remote driver (included)
Driver	Constant current (CC)
Input voltage	220-240 V 50/60 Hz
Optic	O, P

Optic value	108°, 93°
CCT / CRI	3000K CRI80, 4000K CRI80
Bug	B2-U0-G1, B2-U1-G0
ULR	<1%
ULOR	<1%
CIE flux code n°3	96, 97
Dimming type	On/Off, 1-10V, DALI
Product colours	Black, White, Matt Silver, Concrete - Urban, Softscape - Urban, Stone - Urban, Corten - Urban, Oak - Woodland, Walnut - Woodland, Pine - Woodland
Weight	5.6 kg

Operating temperature	-20 °C to 40 °C
Lens / Reflector / Optic	PMMA diffuser with Opal (UGR <19) and micro prismatic (UGR <13) options for better glare control
MacAdam Ellipse	3 SDCM
Lifetime L90B10 (hours)	> 23,000
Lifetime L80B10 (hours)	> 45,000
Lifetime L80B50 (hours)	> 50,000
Variants (On/Off, 1-10V, DALI)	Compatible with EN/ IEC 60598-2-22: Suitable for emergency installations as central supply, non-maintained (Z0)

ARD-80221

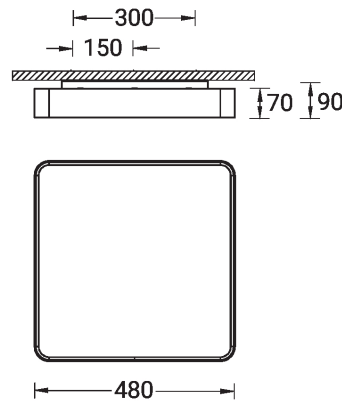

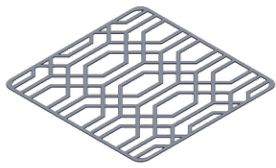
ARDEN 3 (ARD-80221)**Accessory**

Decorative pattern - Type A for
ARDEN 500 mm
A91621

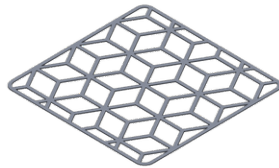

Decorative pattern - Type B for
ARDEN 500 mm
A93021

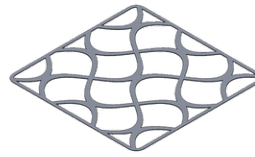

Decorative pattern - Type C for
ARDEN for ARDEN 500 mm
A94421



Wireless bluetooth converter
A90291



Xpress wireless switch
A90591



Emergency module - 250V -
BASIC
EM250V-BA

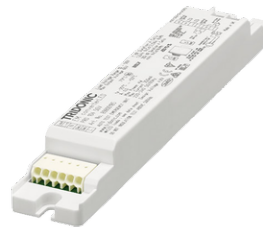

Emergency module - 250V -
PRO-DALI
EM250V-DA

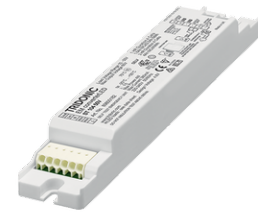

Emergency module - 250V -
SELF-TEST
EM250V-ST



DALI Control System
Control-DALI