

NYBRO 20 (NYB-80972-RE)

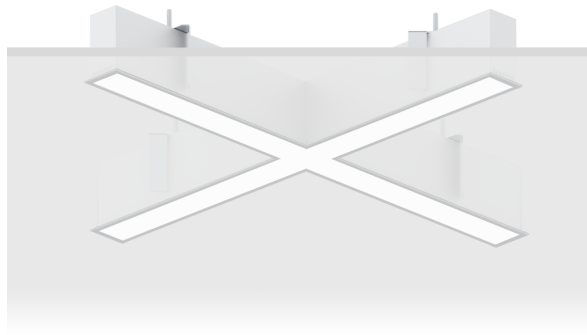

Product description

Down - X90° corner - 60x80 mm - 630 mm - Trimless



microPrim™

Luminaire Structure

- Die-cast aluminium end-caps and extruded aluminium profile with powder coating
- Passive thermal management
- Stainless steel fasteners in grade 304 with zinc flake coating (ZFC)
- PMMA diffuser with Opal (UGR <19) and micro prismatic (UGR <13) options for better glare control
- Integral control gear
- Cut the connection angle according to the shape
- Stainless steel brackets and screws for mounting
- Down light distribution only
- Wireless control available through Bluetooth connection
- Daylight and occupancy sensor options

Optic



Product colour



Special finishes upon request



NYBRO 20 (NYB-80972-RE)

Technical information

Material	Aluminium
Light source	144 LED
Power	25 W
Lumen	2429 - 3055 lm
Efficacy	97 - 122 lm/W
Driver option	Integral control gear
Driver	Constant current (CC)

Input voltage	220-240 V 50/60 Hz
Optic	O, P
Optic value	Opal, Micro-prismatic
CCT / CRI	3000K CRI80, 4000K CRI80
Dimming type	On/Off, DALI
Product colours	Black, White, Matt Silver, Concrete - Urban, Softscape - Urban, Stone - Urban, Corten - Urban, Oak - Woodland, Walnut - Woodland, Pine - Woodland
Weight	4.5 kg

Operating temperature	-20 °C to 40 °C
MacAdam Ellipse	3 SDCM
Lifetime L90B10 (hours)	> 23,000
Lifetime L80B10 (hours)	> 45,000
Lifetime L80B50 (hours)	> 50,000
Variants (On/Off, DALI)	Compatible with EN/ IEC 60598-2-22: Suitable for emergency installations as central supply, non-maintained (Z0)

NYB-80972-RE

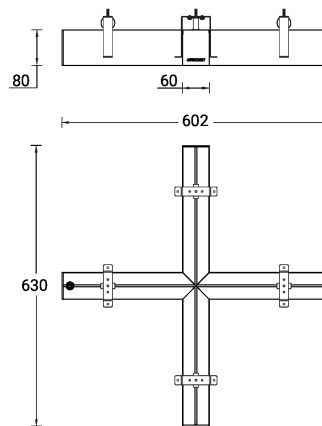

NYBRO 20 (NYB-80972-RE)**Accessory**



Continuous-coupler bracket
(60/70 mm Down & 60 mm
Down & Up profile)
A81581



Trimless-recessed mounting
bracket (60 mm Down profile)
A82581



DALI Control System
Control-DALI
