

ARDEN 4 (ARD-90131)



Product description

Down (Optic) & Up (Optic 2nd) - 600 mm



microPrim™

Luminaire Structure

- Extruded aluminium bended profile with powder coating
- Passive thermal management
- Stainless steel fasteners in grade 304 with zinc flake coating (ZFC)
- PMMA diffuser with Opal (UGR <19) and micro prismatic (UGR <13) options for better glare control

- Remote driver (included)
- Stainless steel, adjustable, suspension (1.5 m) complete with electrical wires in white for mounting
- Up and down light distribution options
- Wireless control available through Bluetooth connection

- Daylight and occupancy sensor options
- Emergency module (1 or 3 hours) is available upon request with 3 options (BASIC, SELF-TEST, PRO-DALI)

Product colour

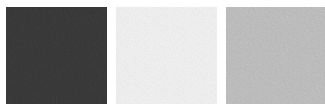

01 - Black (RAL 9011) 03 - White (RAL 9003) 05 - Matt Silver (RAL 9006)

Special finishes upon request

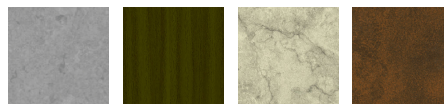

SU01 - Concrete - Urban SU02 - Softscape - Urban SU03 - Stone - Urban SU04 - Corten - Urban

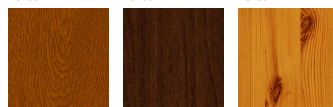

SW01 - Oak - Woodland SW02 - Walnut - Woodland SW03 - Pine - Woodland

ARDEN 4 (ARD-90131)

Technical information

Material	Aluminium
Light source	672 & 240 LED
Power	80 W
Lumen	9895 - 10871 lm
Driver option	Remote driver (included)
Driver	Constant current (CC)
Input voltage	220-240 V 50/60 Hz
Optic	O, P
Optic value	108°, 96°

Optic (2nd)	O
Optic (2nd) value	105°
CCT / CRI	3000K CRI80, 4000K CRI80
Bug	B2-U0-G1, B3-U0-G1
ULR	<1%
ULOR	<1%
CIE flux code n°3	96, 97
Dimming type	On/Off, 1-10V, DALI
Product colours	Black, White, Matt Silver, Concrete - Urban, Softscape - Urban, Stone - Urban, Corten - Urban, Oak - Woodland, Walnut - Woodland, Pine - Woodland

Weight	6.5 kg
Operating temperature	-20 °C to 40 °C
Lens / Reflector / Optic	PMMA diffuser with Opal (UGR <19) and micro prismatic (UGR <13) options for better glare control
MacAdam Ellipse	3 SDCM
Lifetime L90B10 (hours)	> 23,000
Lifetime L80B10 (hours)	> 45,000
Lifetime L80B50 (hours)	> 50,000
Variants (1-10V, DALI)	Compatible with EN/ IEC 60598-2-22: Suitable for emergency installations as central supply, non-maintained (Z0)

ARD-90131

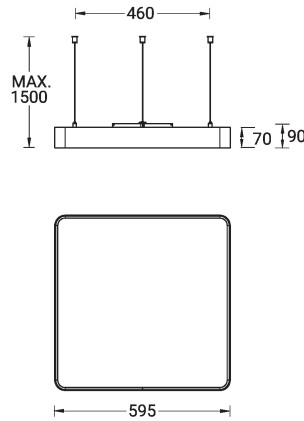

ARDEN 4 (ARD-90131)**Accessory**

Supply cable surface mounting
box
A80981



Wireless bluetooth converter
A90291



Xpress wireless switch
A90591

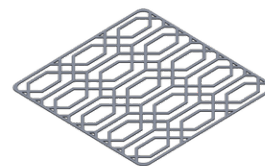

Decorative pattern - Type A for
ARDEN 600 mm.
A91721

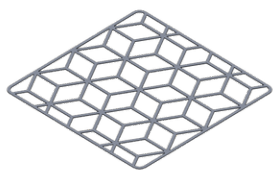

Decorative pattern - Type B for
ARDEN 600 mm
A93121

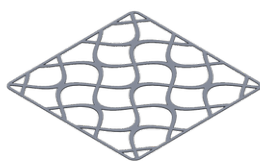

Decorative pattern - Type C for
ARDEN for ARDEN 600 mm
A94521



DALI Control System
Control-DALI