

OULU 6 (OUL-80632)



Product description

Down - 90° - R1250 - Tunable White



microPrim™

Luminaire Structure

- Die-cast aluminium end-caps and extruded aluminium profile with powder coating
- Multiple angles available
- Passive thermal management
- Stainless steel fasteners in grade 304 with zinc flake coating (ZFC)

- Opal PMMA diffuser (UGR <19) for glare control
- Remote driver (included)
- Steel brackets for ceiling down mounting option
- Up and down light distribution options

- Wireless control available through Bluetooth connection

Optic



0

Product colour



01 - Black (RAL 9011) 03 - White (RAL 9003) 05 - Matt Silver (RAL 9006)

Special finishes upon request



SU01 - Concrete - Urban SU02 - Softscape - Urban SU03 - Stone - Urban SU04 - Corten - Urban



SW01 - Oak - Woodland SW02 - Walnut - Woodland SW03 - Pine - Woodland

OULU 6 (OUL-80632)

Technical information

Material	Aluminium
Light source	480 LED
Power	33 W
Lumen	3414 lm
Efficacy	92 lm/W

Driver option	Remote driver (included)
Driver	Constant current (CC)
Input voltage	220-240 V 50/60 Hz
Optic	0
CCT / CRI	TW (2700K - 6500K)

Dimming type	DALI
Product colours	Black, White, Matt Silver, Concrete - Urban, Softscape - Urban, Stone - Urban, Corten - Urban, Oak - Woodland, Walnut - Woodland, Pine - Woodland
Weight	5.0 kg
Operating temperature	-20 °C to 40 °C
Variants (DALI)	Compatible with EN/ IEC 60598-2-22: Suitable for emergency installations as central supply, non-maintained (Z0)

OUL-80632

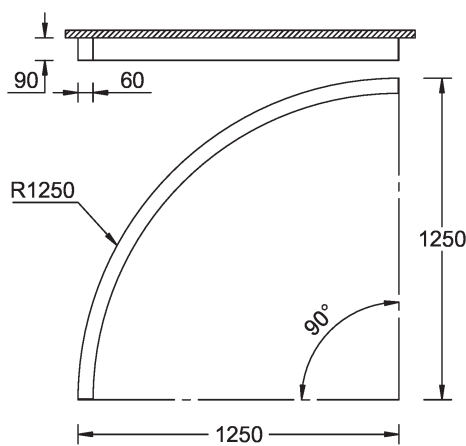

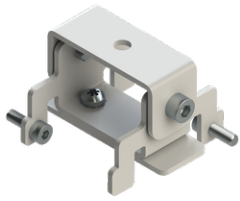
OULU 6 (OUL-80632)**Accessory**

Ceiling-mounting bracket (40 mm profile)
A81381



Continuous-coupler bracket
A81781



Wireless bluetooth converter
A90291



Xpress wireless switch
A90591



DALI Control System
Control-DALI