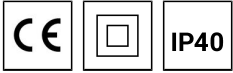
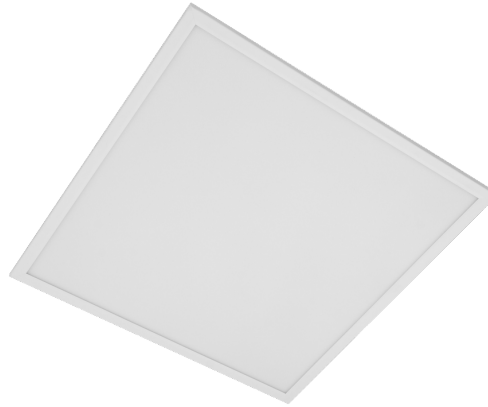
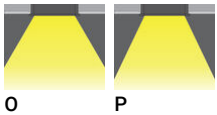

**VIENNA 1 (VIE-80001)****Product description**

600x600 mm

**Luminaire Structure**

- Formed sheet steel body with powder coating
- White painted metal sheet
- UV & flame resistant, chemical & salt stable PVC
- Stainless steel fasteners in grade 304 with zinc flake coating (ZFC)
- PMMA diffuser with Opal (UGR <19) and micro prismatic (UGR <13) options for better glare control
- Integral control gear
- Recessed and surface mounted options
- Accessories: Aluminium frame for surface installation & Aluminium frame for recessed installation of fitting into gypsum plasterboard

**Optic**

O

P

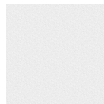
**Product colour**

03 - White (RAL 9003)

**VIENNA 1 (VIE-80001)**

**Technical information**

<b>Material</b>	Aluminium	<b>Driver option</b>	Integral control gear	<b>CCT / CRI</b>	3000K CRI90, 4000K CRI90
<b>Light source</b>	2 x 91 LED	<b>Driver</b>	Constant current (CC)	<b>Dimming type</b>	On/Off, DALI
<b>Power</b>	24 W	<b>Input voltage</b>	220-240 V 50/60 Hz	<b>Product colours</b>	White
<b>Lumen</b>	2900 - 3300 lm	<b>Optic</b>	O, P	<b>Weight</b>	5.0 kg
<b>Efficacy</b>	121 - 138 lm/W	<b>Optic value</b>	Opal, Micro-prismatic	<b>Operating temperature</b>	-20 °C to 40 °C

VIE-80001

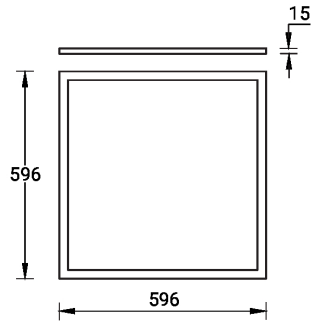

**VIENNA 1 (VIE-80001)****Accessory**

---

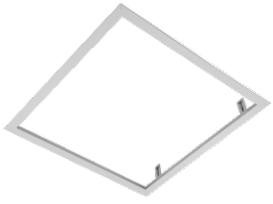

---

Frame for recessed installation  
of fittings into gypsum  
plasterboard ceiling SQUARE  
(White)  
**A83081**

---

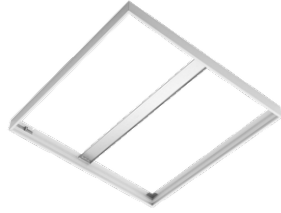

---

Frame for surface installation  
SQUARE (White)  
**A83281**

---



---

Wireless bluetooth converter  
**A90291**

---



---

Xpress wireless switch  
**A90591**

---



---

DALI Control System  
**Control-DALI**

---