

OULU 11 (OUL-90512)



Product description

Down (Optic) & Up (Optic 2nd) - 45° - R1250 - Tunable White



microPrim™

Luminaire Structure

- Extruded aluminium bended profile with powder coating
- Passive thermal management
- Stainless steel fasteners in grade 304 with zinc flake coating (ZFC)
- Opal PMMA diffuser (UGR <19) for glare control

- Remote driver (included)
- Stainless steel, adjustable, suspension (1.5 m) complete with electrical wires in white for mounting
- Up and down light distribution options
- Wireless control available through Bluetooth connection

- Daylight and occupancy sensor options

Optic



0

Product colour



01 - Black (RAL 9011) 03 - White (RAL 9003) 05 - Matt Silver (RAL 9006)

Special finishes upon request



SU01 - Concrete - Urban SU02 - Softscape - Urban SU03 - Stone - Urban SU04 - Corten - Urban



SW01 - Oak - Woodland SW02 - Walnut - Woodland SW03 - Pine - Woodland

OULU 11 (OUL-90512)

Technical information

Material	Aluminium
Light source	240 & 240 LED
Power	31 W
Driver option	Remote driver (included)
Driver	Constant current (CC)

Input voltage	220-240 V 50/60 Hz
Optic	O
CCT / CRI	TW (2700K - 6500K)
Dimming type	DALI
Product colours	Black, White, Matt Silver, Concrete - Urban, Softscape - Urban, Stone - Urban, Corten - Urban, Oak - Woodland, Walnut - Woodland, Pine - Woodland

Weight	3.1 kg
Operating temperature	-20 °C to 40 °C
Variants (DALI)	Compatible with EN/ IEC 60598-2-22: Suitable for emergency installations as central supply, non-maintained (Z0)

OUL-90512

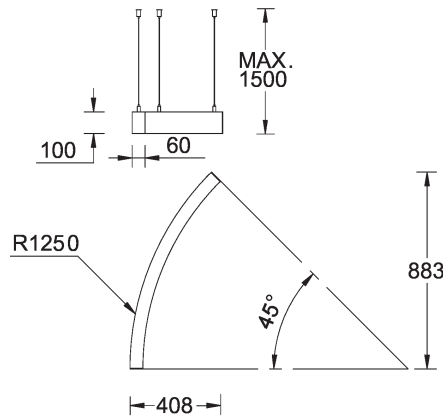

OULU 11 (OUL-90512)**Accessory**

Continuous-coupler bracket
A81781



Supply cable surface mounting
box
A80981



Wireless bluetooth converter
A90291



Xpress wireless switch
A90591



DALI Control System
Control-DALI