

BILLUND 2 (BIU-90054-LC)



Product description

Medium - LIGHTCONNECT™



Luminaire Structure

- Die-cast aluminium housing
- Pre-treated before powder coating ensuring high corrosion resistance
- Thermal heat dissipation body
- Single cable entry
- One IP68 connector supplied with 0.3 m of 3x1.0 sqmm outdoor cable
- Stainless steel fasteners in grade 304 with zinc flake coating (ZFC)
- Durable silicone rubber gasket
- Clear toughened glass
- High-efficiency polycarbonate lens
- Integral control gear
- Surge protection 10kV
- Constant lumen output (CLO) and Night-time dimming options

Optic

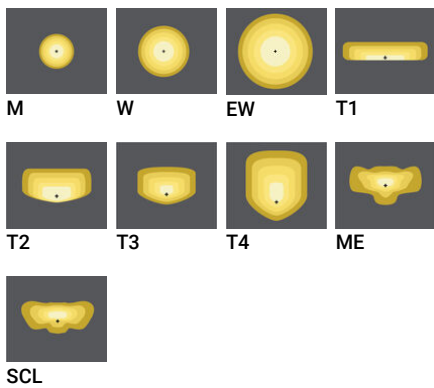

Product colour

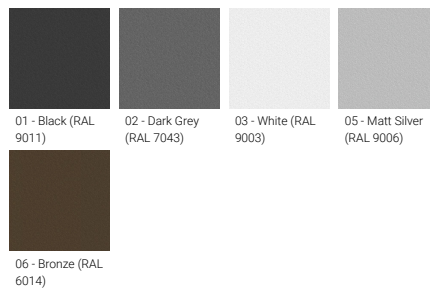

Special finishes upon request

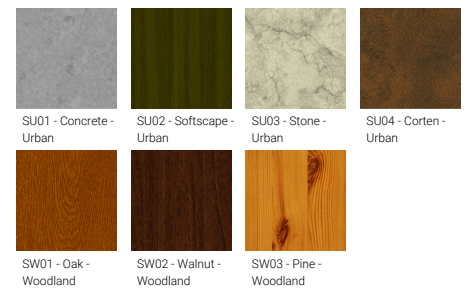

BILLUND 2 (BIU-90054-LC)

Technical information

Material	Aluminium	CCT / CRI	2700K CRI70, 2700K CRI80, 3000K CRI70, 3000K CRI80, 4000K CRI70, 4000K CRI80	Cable	One IP68 connector supplied with 0.3 m of 3x1.0 sqmm outdoor cable
Light source	48 LED	Bug	B2-U0-G2, B3-U0-G2, B3-U0-G3, B4-U0-G1, B4-U0-G4, B5-U0-G1	Through wiring	Single cable entry
Power	156 W	ULR	<1%	Lens / Reflector / Optic	Clear toughened glass, High-efficiency polycarbonate lens
Lumen	14182 - 19759 lm	ULOR	<1%	MacAdam Ellipse	5 SDCM
Efficacy	91 - 127 lm/W	CIE flux code n°3	96, 97, 98, 99	Lifetime L90B10 (hours)	> 35,000
Driver option	Integral control gear	Dimming type	DALI	Lifetime L80B10 (hours)	> 74,000
Driver	Constant current (CC)	Product colours	Black, Dark Grey, White, Matt Silver, Bronze, Concrete - Urban, Softscape - Urban, Stone - Urban, Corten - Urban, Oak - Woodland, Walnut - Woodland, Pine - Woodland	Lifetime L80B50 (hours)	> 80,000
Input voltage	220-240 V 50/60 Hz			Variants (DALI)	Compatible with EN/ IEC 60598-2-22: Suitable for emergency installations as central supply, non-maintained (Z0)
Optic	M, W, EW, T1, T2, T3, T4, ME, SCL	Weight	11.5 kg		
Optic value	31°, 56°, 106°x113°, 149°x72°, 137°x51°, 126°x89°, 103°x74°, 138°x56°, 151°x65°	Operating temperature	-20 °C to 40 °C		
		EPA (m2)	0.068		

BIU-90054

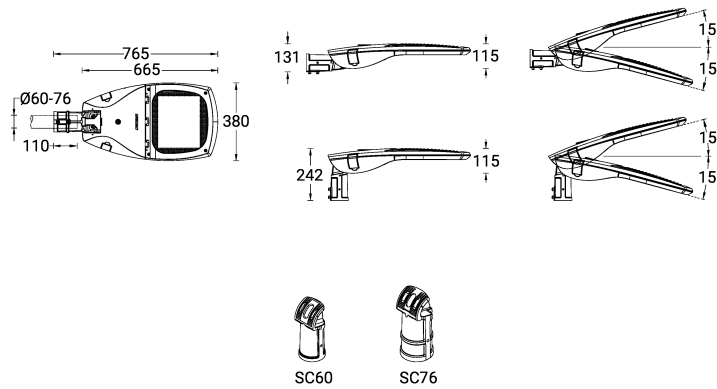

BILLUND 2 (BIU-90054-LC)**Accessory**

NEMA 7 socket
A90891



Zhaga Book 18 socket (Up)
A90991-U



Motion sensor - PIR - DALI - Up
to 3 m
A91691-L2



Motion sensor - PIR - DALI - Up
to 12 m
A91691-L7



Zhaga Book 18 socket (Down)
A90991-D



DALI Control System
Control-DALI