

# SCE-MATRIX-2

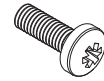

Screw M5(2 pcs.) is included  
for installation luminaire

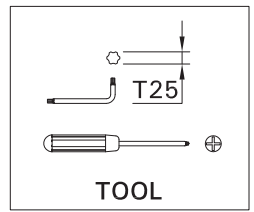
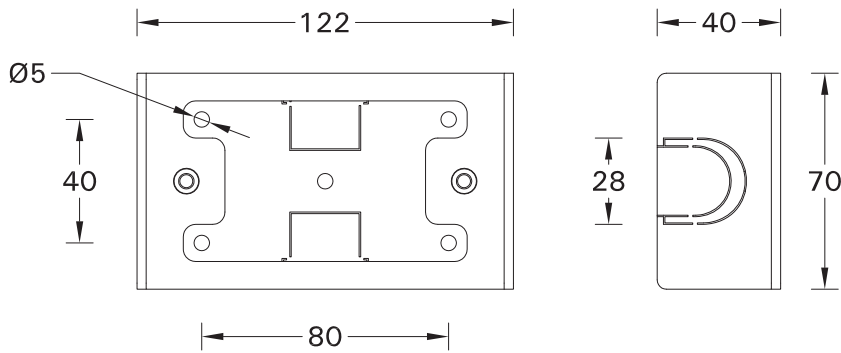