

SCE-MATRIX-9

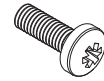

Screw M5(2 pcs.) is included
for installation luminaire

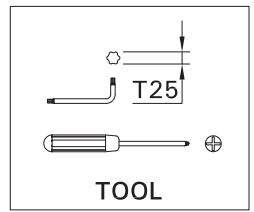
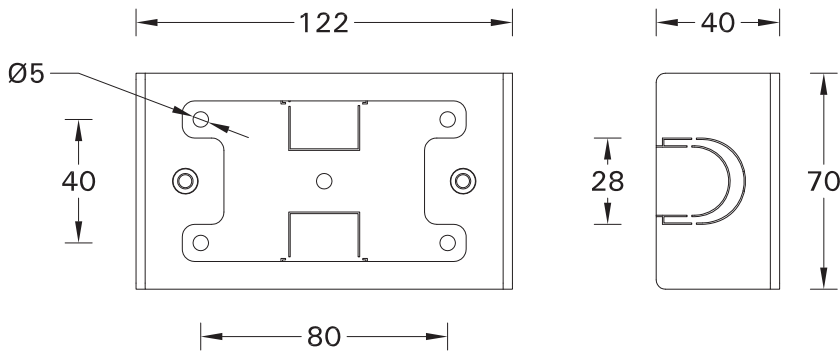