

LIGHTSOFT

Adjustable sensor (5 seconds – 30 minutes)

30° ~ 150° Sensitivity

Sensor detection area: 9 m

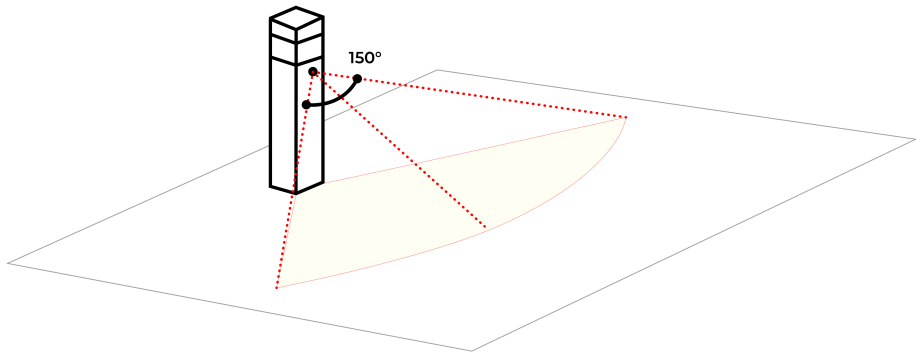

LH-10675-1MS

