

PRAGUE

Adjustable sensor (10 - 150 seconds)

120° sensitivity

Sensor detection area: 7 - 10 m

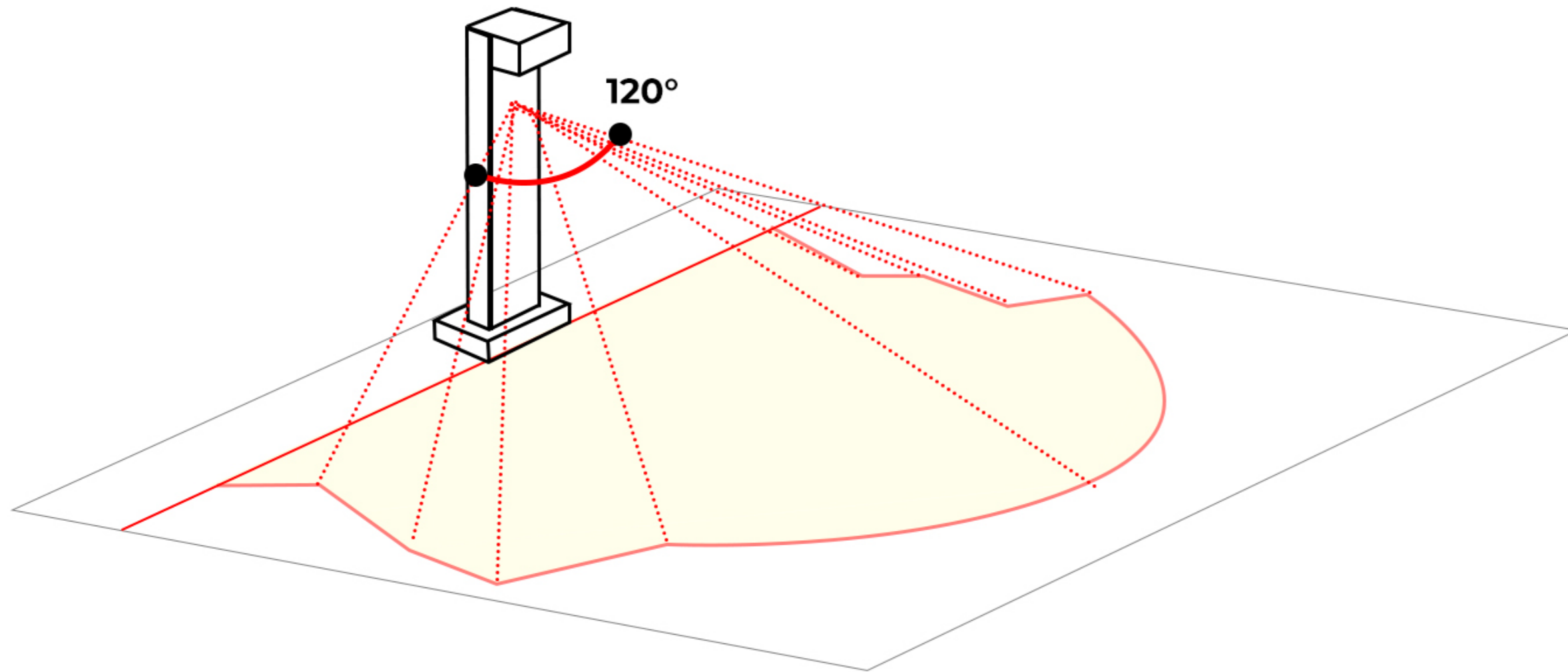

PRA-10053

