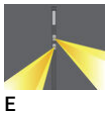
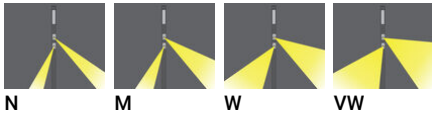

Cluster projectors - LADOR RGBW (2) (LCO-20068-RGBW)**Product description**

2 x LD-50022 projectors

**Luminaire Structure**

- Die-cast aluminium housing
- Pre-treated before powder coating ensuring high corrosion resistance
- Stainless steel fasteners in grade 304 with zinc flake coating (ZFC)
- Durable silicone rubber gasket
- Clear toughened glass
- High-efficiency optical reflector

Optic

Cluster projectors - LADOR RGBW (2) (LCO-20068-RGBW)
Technical information

Light source	2 x 9 LED	Optic	N, M, W, VW, E	ULOR	0, <1%
Power	36 W	Optic value	10°, 16°, 31°, 71°, 10°x42°	CIE flux code n°3	100
Lumen	1602 - 2032 lm	CCT / CRI	3000K CRI80, 4000K CRI80	Dimming type	DMX, DMX/RDM
Efficacy	43 - 55 lm/W	Bug	B1-U0-G0	Weight	18.5 kg
Input voltage	220-240V 50/60Hz	ULR	0, <1%	EPA (m2)	0.148

LCO-20068

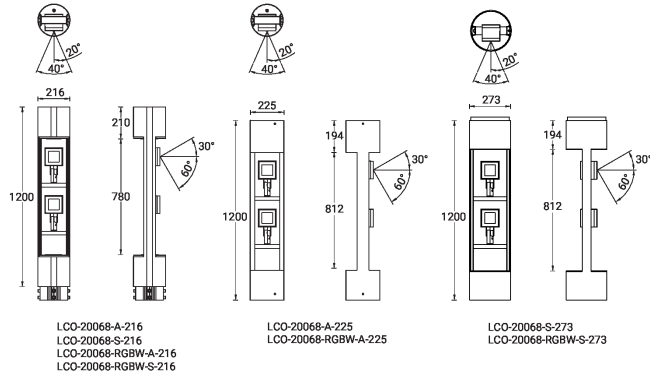

Cluster projectors - LADOR RGBW (2) (LCO-20068-RGBW)**Accessory**

Anti-glare visor
A53031

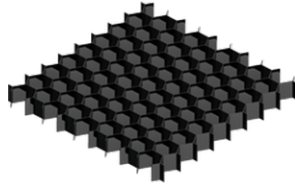

Honeycomb louvre
A52021



Linear spread lens
A51314

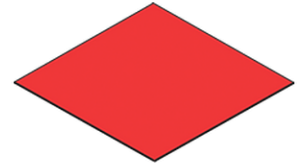

Colour filter (Red)
A51316

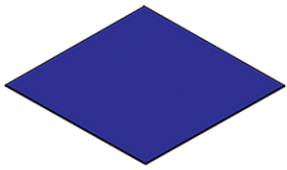

Colour filter (Blue)
A51317

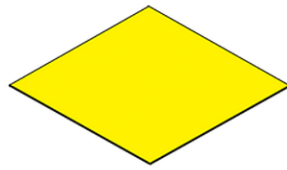

Colour filter (Yellow)
A51318

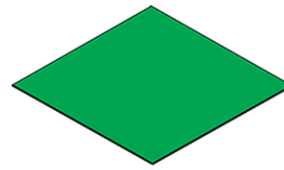

Colour filter (Green)
A51319



Top cover for L-COLUMN
A21591

Please contact the factory for technical details if you wish to use Anti-glare accessories, Colour filters, Lenses and slip glasses in combination.