

VE 741 M05 / M10 / S00

Single-phase charger 7.4 kW with 1 output



- This 7.4kW single-phase charger is designed for the safe and efficient charging of electric vehicles in all types of installations, from residential communities, single-family homes, and private and communal garages to commercial environments such as offices, hotels, hospitals, schools, shopping centers, etc.
- It is especially designed for installations requiring reliable, robust, easy-to-install, and intuitive equipment. It features a state-of-the-art 2.8" LED color TFT display for viewing the charger's status and the charging process.
- The charging process can be managed and monitored via the DINUY-eMobility app, allowing local and remote control of the charger, the addition of charging schedules, and access to the charging history and real-time charger status.
- Full connectivity and compatibility are provided via Bluetooth, Wi-Fi, and Ethernet for connecting the charger to the cloud platform for remote management.
- It has an RFID reader for user identification and charger activation, as well as an output. Each charger is supplied with 4 cards.
- KNX standard for integration into home automation and building automation systems, allowing it to be managed and viewed from inside the residence or office using any standard KNX screen. It also allows for the integration of charger management and load balancing at a central station such as a hotel reception, security service, etc.
- Programming of charging modes and schedules, optimizing energy consumption.
- Dynamic load management based on available or contracted power. Supplied with a balancing load clamp.
- Warranty up to 5 years.



Technical specifications

REFERENCE	VE 741 M05	VE 741 M10	VE 741 S00
Connector	1 x type 2 5 m cable	1 x type2 10m cable	1 x type 2 base
Charging mode	3		
Supply	Single-phase		
Maximum output power	7,4 kW		
Voltage	230 V ac ±10%		
Frequency	50/60 Hz		
Maximum current	32A		
Adjustable load current	From 6 A to maximum current		
Wire section	Up to 10 mm ²		
Connection	Automatic clamp-type terminals without screws		
Communication protocols	Bluetooth, Wi-Fi, Ethernet, KNX, RFID and OCPP		
Installation	Surface / Mural indoors /outdoors		
Covering material	Steel		
Impact resistance	IK10		
Protection degree	IP54		
Dimensions	322 x 249 x 180		
Weight	5,6 kg	8,6kg	4,8 kg
Working temperature	-25°C to 45°C		
Storage temperature	-25°C to 75°C		
Operating humidity	5% to 95%		

Dimensions

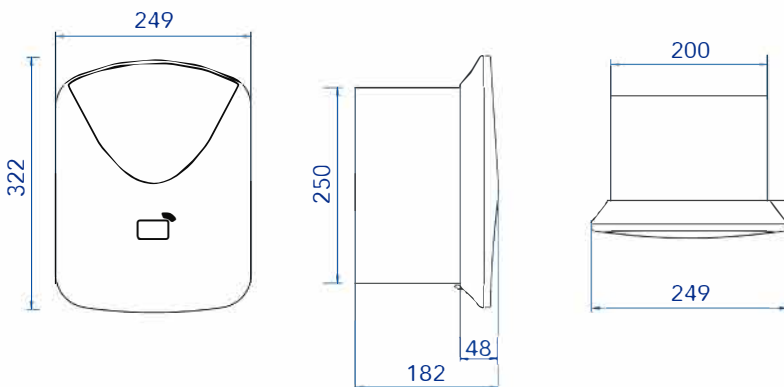

Installation diagram

