

USER MANUAL



CE-ART 7W/G2+
Guard Unit
Wi-Fi connectivity
2-wire installation

CONTENTS

Contents	2
Set-up warnings	2
Compatible with the guard unit.....	2
Characteristics	3
System operation	3
CE-ART 7W/G2+ guard unit.....	4 - 25
Description	4
Installation	5
Installation terminals	5
Configuration switches.....	5
Configuration as guard unit of "building" and operation	6
Configuration as guard unit of "general door panels" and operation	7
Main menu	8
Settings menu	9 - 12
Door panel call screen.....	13
Communication screen	14
Image and communication settings	15
Intercom menu	16 - 17
Recordings menu	18 - 20
Lost call screen.....	21 - 22
Contacts list and configuration "ART7W-G2+ Namelist.csv" file	23 - 25
Cleaning the monitor	26
Special codes	27 - 29
Installation diagrams with guard unit of "building".....	30
Installation diagrams with guard unit of "general door panels" and operation modes (block mode)	31 - 34
Notes	35
Compliance.....	36

SET-UP WARNINGS

- **Always disconnect the power supply** before installing or marking modifications to the devices.
- The fitting and handling of these devices must be carried out by **authorised personnel**.
- The wiring must run at least **40cm away from any other wiring**.
- Do not overtighten the screws of the guard unit connector.
- Install the guard unit in a dry protected location free from the risk of dripping or splashing water.
- Do not place in humid, dusty or smoky locations, or near sources of heat.
- Before connecting the device to the mains, check the connections between the door panel, power supply unit, distributors, monitors and guard unit(s).
- Use the Golmar **RAP-GTWIN/HF** cable (2x1mm²).
- Always follow the instructions contained in this manual.











COMPATIBLE WITH THE GUARD UNIT V03 AND LATER

- EL632/G2+ SE module, **V10** product version and later, EL642/G2+ **V08** product version and later.
- RD/G2+ module, **V05** product version and later.
- ART 1/G2+ terminal, **V10** product version and later.
- T-520 LITE/G2+ telephone, **V02** product version and later.
- T-520/G2+ telephone, **V01** product version and later
- ART4 /G2+ monitor, **V09** product version and later.
- ART 4TH LITE/G2+ monitor, **V04** product version and later.
- ART 4WLITE/G2+ monitor, **V05** product version and later.
- ART 4WH/G2+ monitor, **V04** product version and later.
- ART 7W/G2+ monitor, **V13** product version and later

CHARACTERISTICS

- Hands-free guard unit (Monitor manos libres, (also allows communication with a handset).
- 7" TFT colour screen.
- Touch screen for access and selection of menu function.
- Wifi transmission guard unit to call transfer to mobile smartphone. **(Only the master guard unit can activate Wi-Fi transmission).**
 - Building installation with ART 7W apartments and Wi-Fi activated (FA-ART 7W power supply unit required for apartment / guard unit of building, (see page 30)).
 - General door panels installation with ART 7W apartments and Wi-Fi activated (FA-ART 7W power supply unit required for apartment) the guard unit connected between the RD-G2+ and the FA-G2+ power supply of the general door panels, no additional power supply FA-ART 7W required, (see pp. 31-33). **Note:** Scroll from guard unit, only general door panels & CCTV of general door panels.
 - General door panels installation with ART 7W apartments and Wi-Fi activated (FA-ART 7W power supply unit required for apartment/ guard unit of building, see page 32). **Note:** Scroll from guard unit of building, door panels & CCTV of the building door panels and door panels & CCTV of the general door panels.
- Guard unit with simple installation (non-polarised 2 wires bus).
- Guard unit of (building) or guard unit of (general door panels), only one mode of guard unit in the installation.
- Up to 4 guard units as master and slave for (conciierge "building" or "general door panels").
- User menu.
- Installer menu.
- Image and communication settings menu.
- Output to auxiliary call repeater (maximum 50mA/12Vdc).
- "HZ" input for calls from door.
- Door release 1 and 2 activation icons screen.
- Notification leds.
- Configuration switches to set the guard unit (with address 1 or 128 and end of line).

SYSTEM OPERATION

- To make a call to guard unit, the visitor must press the corresponding call button to guard unit; an audible sound indicates that the call is being made and LED  will turn on. If vocal synthesis is enabled, a 'Call is in progress' message appears indicating that a call is being made. At this moment, the guard unit receive the call. If another call button is pressed by mistake, press the correct call button to guard unit and the first call will be cancelled.
- Upon receiving the call, the image will appear on the screen of the master guard unit (and slave 1, if it exists) without the visitor knowing and icon  displayed on the screen will blink green. To view the image from slave guard units 2 or 3, press the screen for the image to appear. If the call is not answered within 45 seconds, LED  will turn off and the system will become free.
- If call transfer to your mobile phone has been programmed, you can cancel the transfer at any time from the monitor, with it being necessary to communicate with the door panel from the main menu.
- To establish communication, press off-the-hook icon  on the screen or (lift the handset) of any guard unit. Door panel LED  will turn off and the led  will turn on.
- Connection will last for 90 seconds or until on-the-hook icon  is pressed on the screen or (hang up the handset only if communication has been established by lifting the handset) on guard unit. When communication ends, LED  will turn off and the system will become free. If vocal synthesis is enabled, a 'Communication is finished' message will indicate that the call is over.
- To open door  or  of the door panel, press the corresponding icon on the screen during the call or communication processes: one press will activate the lock release for 3 seconds and LED  will also turn on for 3 seconds. If vocal synthesis is enabled, a 'Door is open' message will be indicated on the door panel.
- Detailed operation and configuration of the guard unit is described on pp.6-25.

CE-ART 7W/G2+ GUARD UNIT

Description

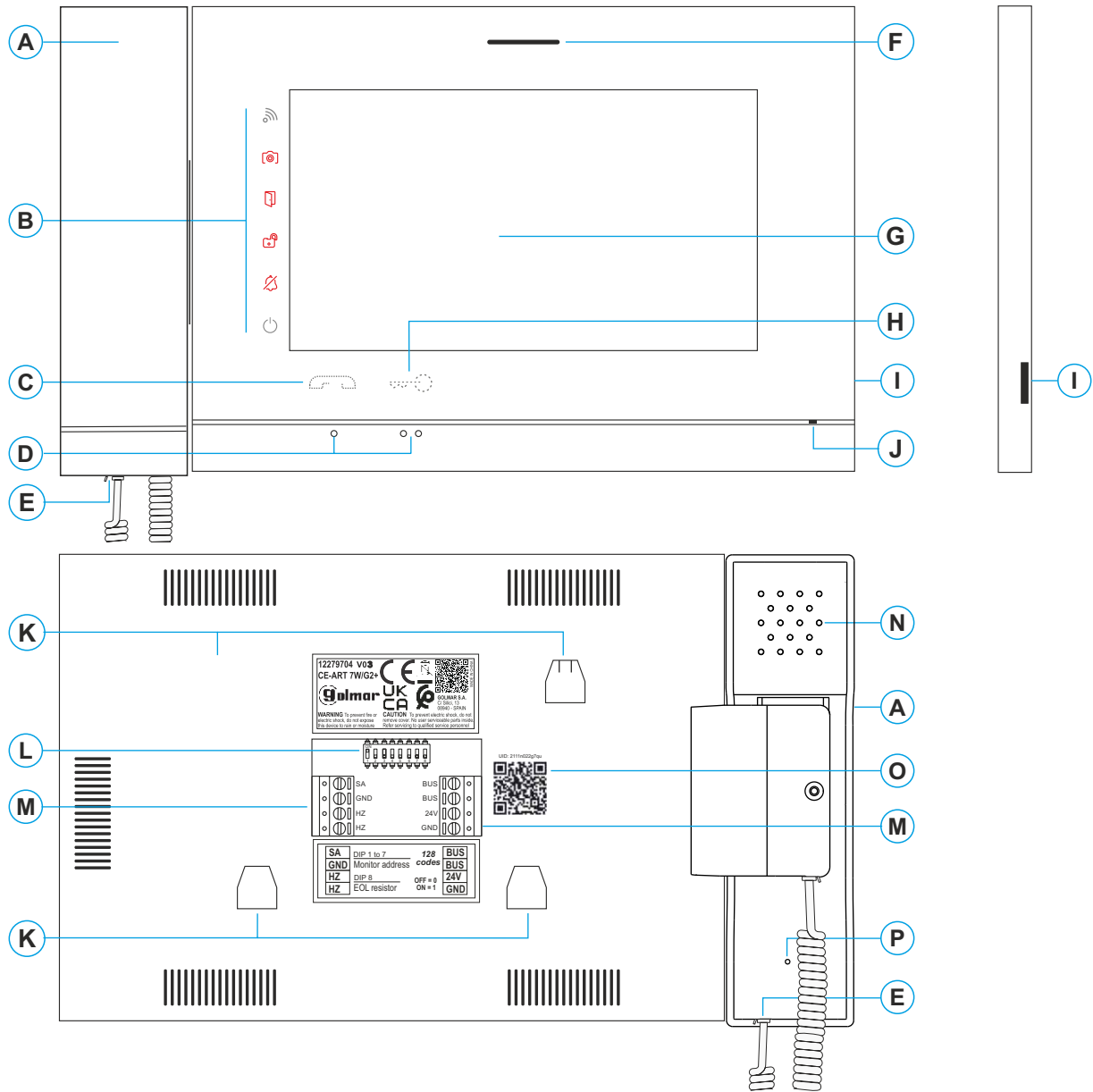

- A.** Handset.
- B.** Notification icons:
 - ⏻ Power on indicator.
 - 🚫 Do not disturb.
 - 🔌 Auxiliary relay activated.
 - 🚪 Door opening.
 - 📷 New image/video.
 - 📶 Wi-Fi transfer activated.
- C.** Hidden (icon) start/stop communication button: For the visually impaired, by default deactivated (see p. 27-28 'special codes').
- D.** Raised dots for the visually impaired.
- E.** Cable slot.
- F.** Speaker (hands-free communication mode).
- G.** Touch screen.
- H.** Hidden (icon) door opening button. For the visually impaired, by default disabled (see p. 27-28 'special codes').
- I.** MicroSD card slot (not included).
Type: MicroSD Class 10 from 4Gb to 128Gb (speed 90Mb/s or higher).
- J.** Microphone (hands-free communication mode).
- K.** Wall mounting connector fixing (x4).
- L.** Configuration switches.
- M.** Installation terminals.
- N.** Speaker (communication with handset).
- O.** UID code label of the guard unit.
- P.** Microphone (communication with handset).

CE-ART 7W/G2+ GUARD UNIT

Installation

Avoid dusty or smoky environments or locations near sources of heat.
 For proper installation, use the template supplied with the product.

1. Position the top of the template at a height of 1.65m.
2. If you are going to use an embedding box to pass the wiring through, make sure that it is in line with the holes corresponding to the box model chosen and fix the connector. If you prefer to fix the connector directly to the wall, make four 6mm holes at the points indicated (A), insert the wall plugs supplied and screw in the connector.
3. Pass the installation wires through the middle hole and connect them to the removable terminals as shown in the wiring diagrams. Before connecting the removable terminals to guard unit, configure the switch as indicated below.
4. Connect the removable terminals to the guard unit and place the guard unit in front of the connector, making sure the fixings line up. Move the guard unit downwards to secure it.

Installation terminals (M)

For ease of installation, the installation terminals are removable and supplied in a separate bag. Once the terminals are wired, place them in position.

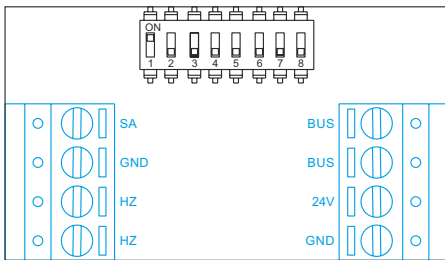

BUS, BUS: communications bus (non-polarised).
 24V, GND: local power input.
 SA, GND: auxiliary call repeater output (maximum 50mA/12V).
 HZ, HZ: apartment front door button input:
 Connect only on the master guard unit. The signal received is then transmitted to the slave guard units in the same apartment through the BUS.

Note: HZ push button function mode: When HZ push button is pressed will be call tone and activate the output of auxiliary call repeater with standby guard unit, call process, communication process (HZ tone with lower audio level), intercom process and "Do not disturb" mode.

Configuration switches (L)

Dip1 to Dip7: Sets the guard unit with address 1 or address 128.

Address 1



To apply the hidden codes:
 5001 Guard unit of (building)
 5002 Guard (general panel)

Address 128



To apply the hidden codes:
 5005 Guard unit of (building)
 5007 Guard (general panel)

Dip8: Configure the end of line. Leave ON at the guard unit that ends the Bus cable. Deactivate it only in intermediate guard units.

Dip 8 to ON



Dip 8 to OFF



To define whether the guard unit is master or slave:

If there are more than one of the guard unit (up to 4 guard units), to define whether the guard unit is master or slave (see special codes page 27 to 28) **Note:** Only one master guard unit for (concierge "building" or "general door panels").

Important: Only the master guard unit can activate the Wi-Fi transmission.

CE-ART 7W/G2+ GUARD UNIT

"Settings as guard unit of "building"

The guard unit/s to set as guard unit of "building" (Up to 4 guard units), must be configured with **address 1 or 128** and as **master, slave 1, slave 2 or slave 3**., the installation must be connected all guard units, monitors, telephones and door panels (the monitor/s of apartment 1 or 128 must be set with a "free" address call different to 1 or 128 depending on the address of the guard unit). Then enter the special code "**5001"or "5005"**" (see page 5) in a master guard unit (see special codes on pages 27 to 28), the guard unit/s with address 1 or 128 will be now a guard unit/s of building with **address 129** and displaying the symbol  at the top left of the main menu screen (now set with address 1 or 128 the monitor/s of the apartment 1 or 128). **Note:** The access door panel will auto-configure the **button P1** on the EL632/G2+ SE module with the **call address 129**.

Important: Guard unit V03 compatible with the EL632/G2+ SE V10 and later.

Dip1 to Dip7: Sets the guard unit with address 1, (Dip1 to ON and dip2-Dip7 to OFF).

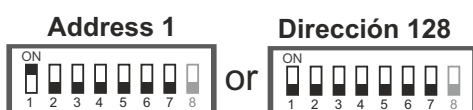



Dip8: This activates the end-of-line resistance in the ON position. Activate it in guard unit where the bus cable ends. Deactivate it only in intermediate guard units.



Note: If there are more than one of the guard unit (up to 4 guard units), to define whether the guard unit is master slave 1, slave 2 or slave 3 (see special codes page 27 to 28) **Note:** Only one master guard unit in the concierge "building".

Important: Only the master guard unit can activate the Wi-Fi transmission.

Operation of guard unit of "building":

- The master and slave guard units/s receive the call from the access door panel/s (by pressing button P1 on the sound module).
- The master and slave guard unit/s can be autoswitch-on with the access door panel 1.
- The master and slave guard unit/s, receive calls from the apartments (by pressing the button below icon  on the main menu of the apartment monitor).
- The master and slave guard monitor(s) allow you to call the apartments through the intercom menu by means of the hidden code (second call table), the contact book and the missed calls screen. Note: with the control panel in standby (black screen), when the handset is taken off hook, it accesses the intercom screen for calls to the apartments, by means of a numerical hidden code (second call table).
- It allows internal intercommunication between the guard units.
- New icon  in the master menu, for internal calls to all guard units.
- Fast forward in the search for users in the contact book.
- The master and slave guard unit/s, allow the capture of apartment calls make from the selected building door panel/s (see special codes page 27 to 28). If the "night mode" of operation is enabled for the guard unit/s (see special codes page 27 to 28), calls to apartments from the building door panel/s are not captured by the guard unit/s when the door panel where the call is made detects "low light conditions".
- The master and slave guard units allow intercommunication with a monitor in an apartment, displaying the image of a door panel or the connected camera of a door panel (see special codes page 27 to 29).
- Allows the display to remain on for 30 minutes (see pages 27 to 29).

Notes:

- Scroll from central guard unit of (general door panels), only up general door panels & CCTV of general door panels, (see pages 31-33).
- Scroll from central guard unit (building), door panels & CCTV of building door panels and door panels & CCTV of general door panels, (see page 34).

CE-ART 7W/G2+ GUARD UNIT

Settings as guard unit of "general door panels"

The guard unit/s to set as guard unit of "general door panels" (up to 4 guard units), must be configured with **address 1 or 128** and as *master, slave 1, slave 2 or slave 3*., the installation must be connected all guard units, monitors, telephones and general door panels (the monitor/s of apartment 1 or 128 of different buildings must be set with a "free" address call different to 1 or 128). Then enter the special code "**5002**" or "**5007**" (see page 5), from master guard unit (see special codes on pages 27 to 28), the guard unit/s with address 1 or 128 will be now a guard unit/s of general door panels with **address 129** and displaying the symbol  at the top left of the main menu screen (now set with address 1 or 128 the monitor/s of the apartment 1 or 128 of the different buildings). **Note:** The general access door panel will auto-configure the *button P1* on the EL632/G2+ SE **V10** and later.

Important: Guard unit **V03** compatible with the EL632/G2+ SE **V10** and later.

Dip1 to Dip7: Sets the guard unit with address 1 or 128.



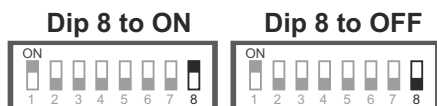

Dip8: This activates the end-of-line resistance in the ON position. Activate it in guard unit where the bus cable ends. Deactivate it only in intermediate guard units.



Note: If there are more than one of the guard unit (up to 4 guard units), to define whether the guard unit is master or slave (see special codes page 27 to 28). **Note:** Only one master guard unit for (concierge "building" or "general door panels").

Important: Only the master guard unit can activate the Wi-Fi transmission.

Operation of guard unit of "general door panels":

- The master and slave guard units/s receive the call from the general door panel/s (by pressing button P1 on the sound module).
- The master and slave guard unit/s can be autoswitch-on with the general door panel 1.
- The master and slave guard unit/s, receive calls from the apartments (by pressing the button below icon  on the main menu of the apartment monitor).
- The master and slave control panels allow the apartments to be called via the intercom menu by means of a numerical hidden code (second call table), the contact list and the missed call display. Note: with the control panel in standby (black screen), when the handset is taken off hook, it accesses the screen for intercommunication of calls to the apartments, by means of a numerical hidden code (second call table).
- It allows internal intercommunication between the guard units.
- New icon  in the master menu, for internal call to all exchanges.
- Fast forward to search for users in the address list.
- The master and slave guard units/s, allow the capture of apartment calls made from the selected general door panel/s (see special codes page 27 to 28). If the "night mode" of operation is enabled for the guard unit/s (see special codes page 27 to 28), calls to apartments from the general door panel/s are not captured by the guard unit/s when the general door panel where the call is made detects "low light conditions".
- The master and slave guard units allow intercommunication with a monitor in an apartment, displaying the image of a door panel or the connected camera of a door panel (see special codes page 27 to 29).
- Allows the display to stay on for 30 minutes (see pages 27 to 29).

Notes:

- Scroll from guard unit of (general door panels), only general door panels & CCTV of general door panels (see pages 31-33).
- Scroll from (building) guard unit, door panels & CCTV of building panels and door panels & CCTV of general door panels, (see page 34).

CE-ART 7W/G2+ GUARD UNIT

Main menu

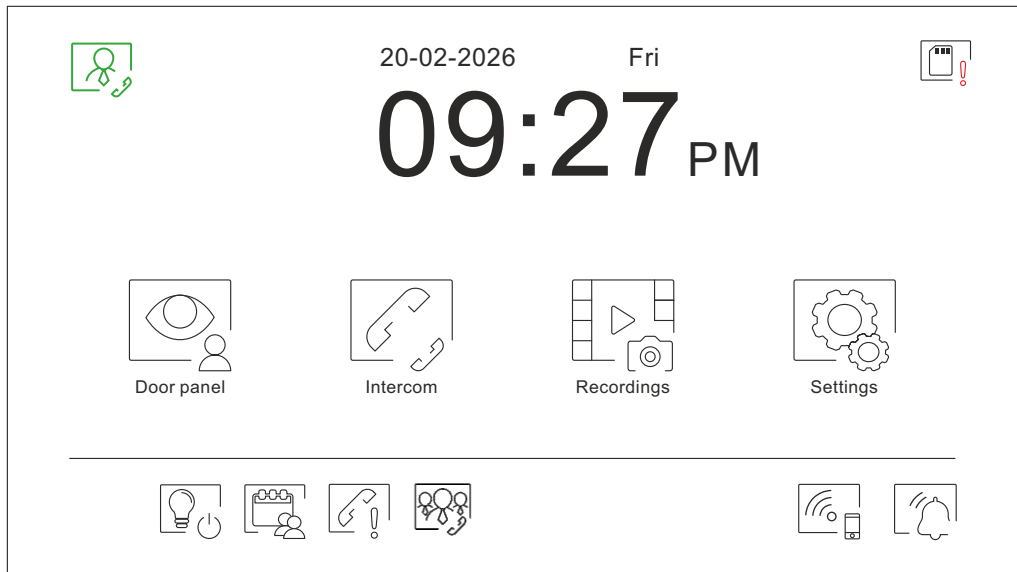

If the device is in standby (screen off), touch any part of the screen to activate it and bring up the main menu. The device will return to standby mode after 20 seconds without activity.



Display the image from the door panels and cameras connected to the system. This enables the door panel camera to be changed, the audio of the corresponding door panel to be activated and the door to be opened. The icon can be set to disable or enable in the main menu, the icon will change colour (grey off, white on). See special codes pages (programmable by the installer).



Access the menu for intercom with others guard unit/s (internal intercom) or with apartments (external intercom).



Display the list of images recorded in the device memory. If there are new or unseen images, the number will be displayed in the top right of the icon and notification led  will illuminate. If the number is greater than 9, three points will be displayed.

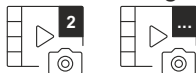

Change the system settings.



By setting the CE-ART 7W/G2+ as guard unit of (building) or of (general door panels), the icon  will appear on main menu of the apartment's monitors. Press to make a call to the guard unit, (see special codes pages 27 to 28).



Press to "staircase light" activation (SAR-G2+ & SAR-12/24 modules required).



Indicates that the inserted MicroSD card must be formatted from the monitor. Press to access the storage functions menu and format the card.



Show the list contacts, it allows intercom calls to apartments (micro SD card must be inserted, see pages 23 to 25).



Show the list lost call to guard unit make from the apartment/s or of the door panel/s, indicating the date and time when they were make. Allows you to answer and delete from the list of lost calls (recorded in the unit's memory), see pages 21-22.



Press to call 'Intercom' to all guard units.



Press for 3 seconds to activate/deactivate Wi-Fi transmission. The icon will change colour (white on, grey off) and notification icon  will illuminate depending on the status.

Important: Only the master guard unit can activate Wi-Fi transmission.



Press for 3 seconds to activate or 1 second to deactivate the 'Do not disturb' function (the guard unit does not sound when a call (see note "HZ" page 5) is received). The notification icon will illuminate depending on the status.

CE-ART 7W/G2+ GUARD UNIT

Settings menu

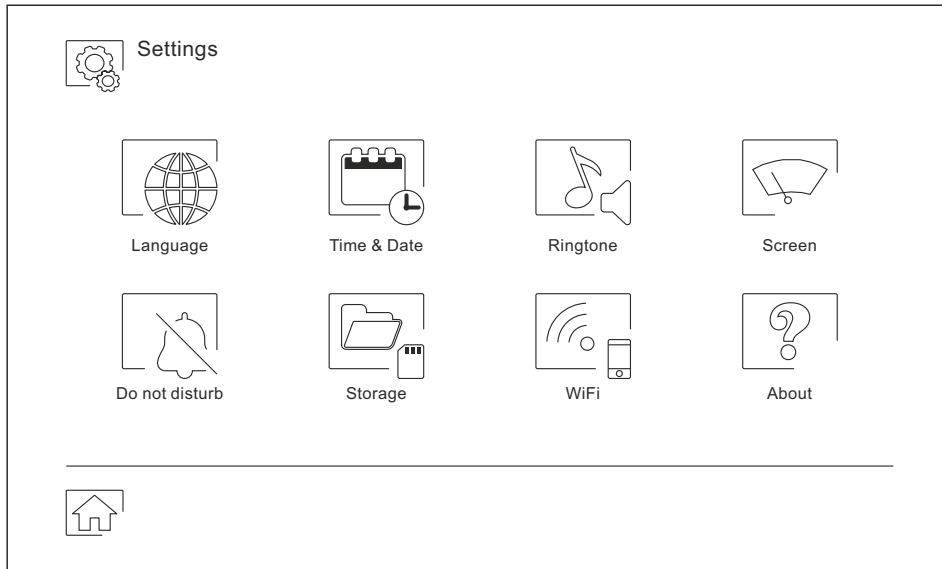

Use icon  to return to the main menu.



Select one of the 16 languages available for the user interface. Once selected, confirm by pressing icon , and the monitor returns to the settings menu.





CE-ART 7W/G2+ GUARD UNIT



Settings menu

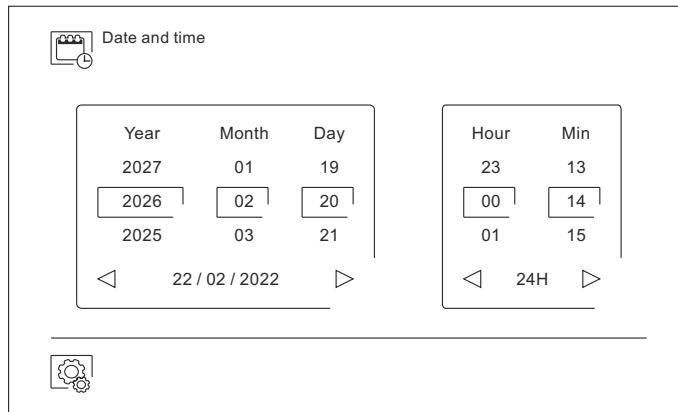

Set the date and time of the system, and the presentation format. Change the values by sliding up or down, and use the arrows to change the formats. Validate the changes made with icon , and the guard unit will return to the settings menu.



Adjust the call volume and identify the origin of the calls when you are not in front of the guard unit, select the desired volume and melodies using the arrows. Once finished, confirm your selection with icon .

Note: Tap on the icon  to activate/deactivate call tones 45 seconds.
 Function duration of call tones 45 seconds deactivated  (factory default).
 Function duration of call tones 45 seconds activated .

1st ringtone screen

2nd ringtone screen

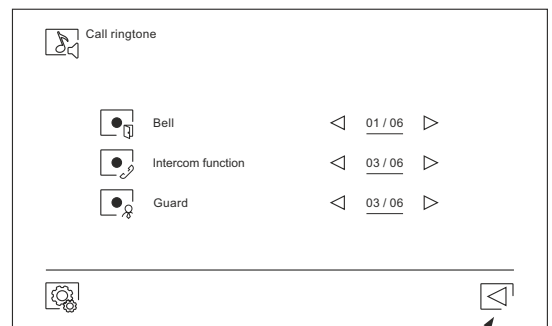
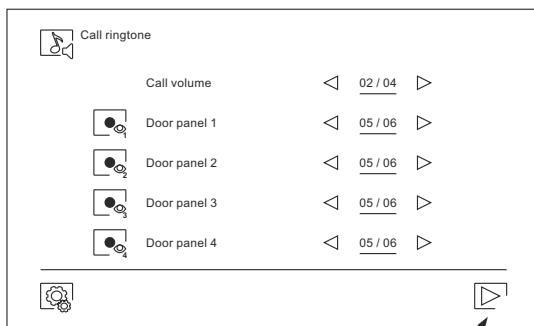

Access the 2nd screen 

Access the 1st screen 



Customise the guard unit with one of the six available wallpapers, display the guard buttons (no function), light and the date/time on the main menu screen. Validate the changes made with icon , and the monitor will return to the settings menu.

- Use of the **Soul Access** door panel with **V07** and later.-Maximum one Soul Access door panel in the installation with address 1).
- Allows management of the hidden codes from an **ART 7W** monitor with **V13** and later.
- The use of the **Soul Access** door panel with **V07** and later, allows management with the **Android App G2Call+** from **V.3.1** or with the **iOS App G2Call+** from **V.3.1**. Access the 'Security' screen of the G2Call+ App and then click on the option 'Manage the hidden codes'.

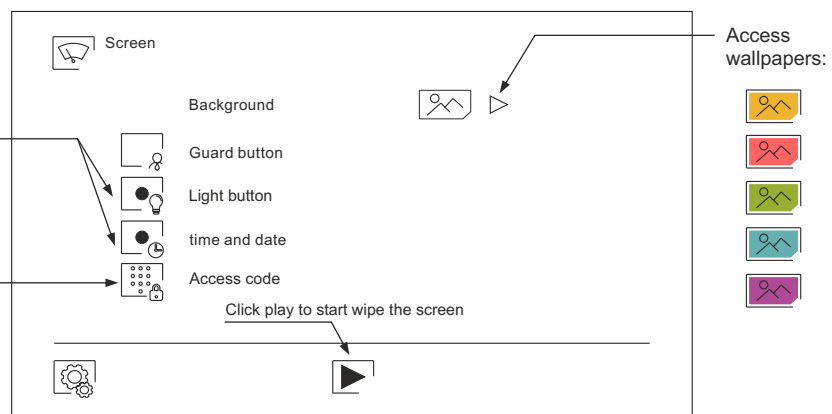

-(**Note:** The Soul Access door panel does not allow the CE-ART 7W/G2+ guard unit to capture the call, see corresponding manual).

Important: The CE-ART7W/G2+ control unit allows you to configure the special hidden code '0801' to enable or '0800' to disable the icon. "Access hidden code" (see pages 27 to 29). **The hidden code '0801' must be set before configuring the WiFi transmission.**

CE-ART 7W/G2+ GUARD UNIT

Settings menu



In the 'Do not disturb' settings, you can set a period of time during which the guard unit will not sound (see note "HZ" page 5) when receiving calls. To do so, select the do not disturb function and choose the time period. From the main menu, you can enable and disable the 'Do not disturb' function regardless of the timer status.

If you wish to be contacted from another monitor in another apartment, activate the intercom function.

To activate the automatic door opening function (3 seconds after receiving a call from the door panel), select the 'Automatic door opening' function. Then choose the time period. **(This function is disabled by default. Programmable by the installer).**

Validate the changes made with icon , and the monitor will return to the settings menu.

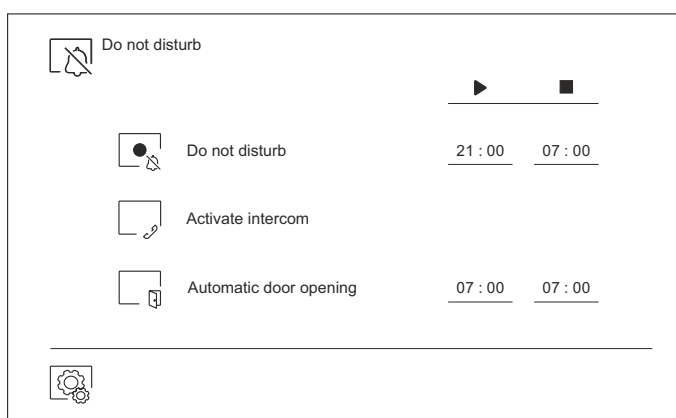

In some countries, the law does not permit the storage of images or videos for more than 30 days after recording. The automatic deletion function performs this task for you. You can disable this function if your country's legislation does not require it, or under your responsibility.

If you have not inserted a MicroSD card into your monitor, only still images can be recorded in the internal memory of the monitor (up to 100). If you have inserted one, the images and videos will always be recorded on the card, and the images in the internal memory cannot be displayed until you copy them to the card.

From this menu, you can delete contents, copy from the internal memory to the SD card and format the card. Any of these actions will require confirmation.

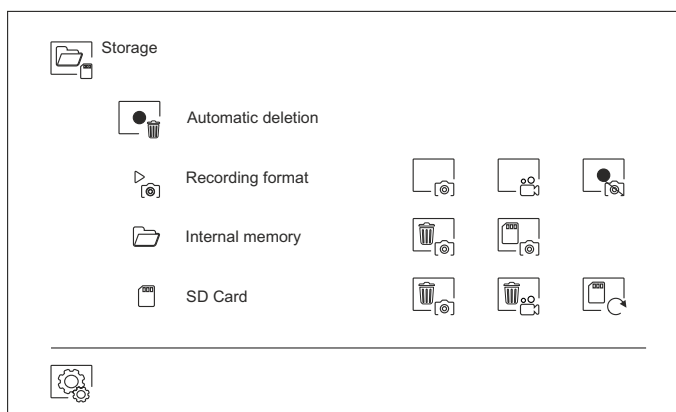

Use icon  to return to the settings menu.



Note: Allow disable/ enable images recording, **(Programmable by the installer).**



CE-ART 7W/G2+ GUARD UNIT

Settings menu

 During the first startup of the device, we recommend resetting the Wi-Fi parameters using icon . Note that **only the master guard unit can activate Wi-Fi transmission**.

The Wi-Fi menu shows information about the identity of the guard unit (UID), the name of the network to which it is connected (SSID) and the signal strength. To connect the monitor to your Wi-Fi network, you must use the app G2Call+:

G2Call+: For the configuration and settings of the app, click on the following link to access the "TAPP G2Call+" manual
[https://doc.golmar.es/search/manual/50123137:](https://doc.golmar.es/search/manual/50123137)

Using icon , select the desired transfer mode ('instant' start of the call transfer to the mobile phone within 3 seconds of making the call on the door panel, 'No answer' start of the call transfer to the mobile phone 50 seconds after making the call on the door panel, "15s" start of the call transfer to the mobile phone 18 seconds after making the call on the door panel and "Do not divert" there is no call transfer to the mobile phone. Validate the changes made with icon , and the monitor will return to the settings menu.

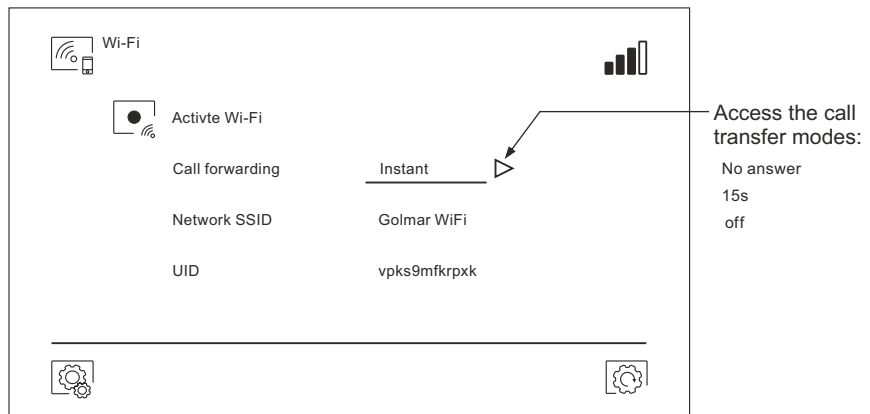

 The 'About' screen provides information about the device, such as the guard unit firmware version and its address.

Press 'Instructions manual' or 'Apps' to display the QR code that will take you to the updated downloads of this instruction manual and the G2Call+ app for your mobile phone.

Use icon  to restore factory settings, such as language, melodies, etc. Wi-Fi parameters will not be modified.

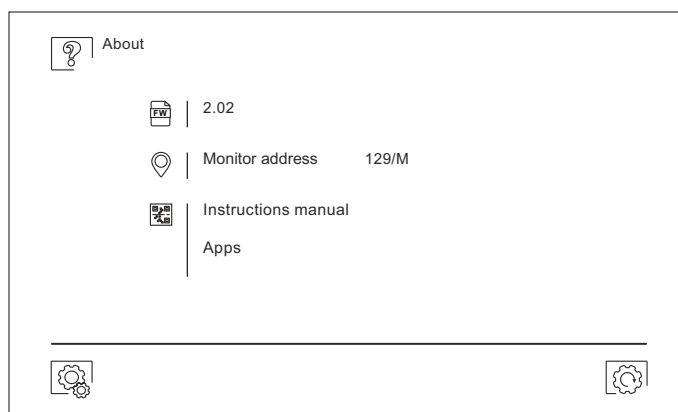

Use icon  to return to the settings menu.



CE-ART 7W/G2+ GUARD UNIT

Door panel call screen



This screen is displayed when receiving a call or pressing icon  of the main menu. During a call, icon  displayed on the screen will blink green (during the call process). In the top centre of the screen, the date and time are shown and, on the right, the source of the image is displayed. The call has a duration of 45 seconds.



The ringtone ends.





Access the image and communication settings menu.



Change the source of the image as long as the system has more than one door panel or has an external camera connected and display has been activated (see p. 27-28). It is possible to make the change during display, call and communication processes.



Start  or end  audio communication with the door panel displayed. Communication has a maximum duration of 90 seconds. Once communication has ended, the screen will turn off.





Activate the lock release (or device connected to the relay 1 output of the door panel) for 3 seconds (factory setting, programmable by the installer). During activation, indicator  will illuminate.





Activate the lock release (or device connected to the relay 2 output of the door panel) for 3 seconds (factory setting, programmable by the installer). During activation, indicator  will illuminate.



A few seconds after receiving a call, it automatically takes a photograph. In the top left of the screen, icon  is displayed and indicator  will illuminate.

By pressing, it takes a photograph. (See p. 11 to set the recording mode).



if you have a MicroSD card inserted, it starts recording a 15-second video within a few seconds of receiving the call. Otherwise, it will take a photograph. In the top left of the screen, icon  is displayed and indicator  will illuminate.

By pressing, it records a video. (See p. 11 to set the recording mode).

CE-ART 7W/G2+ GUARD UNIT

Communication screen

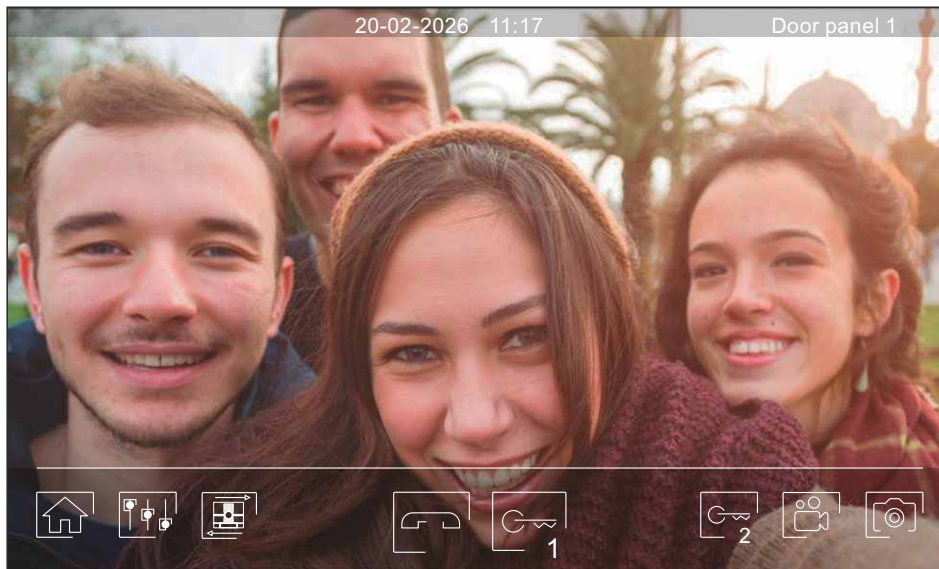

This screen is displayed during a communication process. In the top centre of the screen, the date and time are shown and, on the right, the source of the image is displayed. Communication has a maximum duration of 90 seconds.



End audio communication with the door panel displayed and then show the main menu.



Access the image and communication settings menu.



Change the source of the image as long as the system has more than one door panel or has an external camera connected and display has been activated (see p. 27-28). It is possible to make the change during display, call and communication processes.



Start or end audio communication with the door panel displayed. Communication has a maximum duration of 90 seconds. Once communication has ended, the screen will turn off.



Activate the lock release (or device connected to the relay 1 output of the door panel) for 3 seconds (factory setting, programmable by the installer). During activation, indicator will illuminate.



Activate the lock release (or device connected to the relay 2 output of the door panel) for 3 seconds (factory setting, programmable by the installer). During activation, indicator will illuminate.



A few seconds after receiving a call, it automatically takes a photograph. In the top left of the screen, icon is displayed and indicator will illuminate.

By pressing, it takes a photograph. (See p. 11 to set the recording mode).



if you have a MicroSD card inserted, it starts recording a 15-second video within a few seconds of receiving the call. Otherwise, it will take a photograph. In the top left of the screen, icon is displayed and indicator will illuminate.

By pressing, it records a video. (See p. 11 to set the recording mode).



CE-ART 7W/G2+ GUARD UNIT

Image and communication settings

During the display or call process, it is possible to adjust the image parameters (brightness, contrast and colour). Press icon  and use the slider bars to adjust the settings. By pressing the icon again, the settings window will disappear.



During the communication process, it is possible to adjust the image parameters (brightness, contrast and colour), and the audio level of the monitor speaker.

Press icon  and use the slider bars to adjust the settings. By pressing icon  again, the settings window will disappear.



CE-ART 7W/G2+ GUARD UNIT

Intercom menu

From this menu, you can contact other guard unit/s (internal intercom) or with apartments (external intercom). To do so, your guard unit and the monitor called must have the intercom function activated from the 'Do not disturb' menu (see p. 11).

Use icons  and  to switch between internal and external intercom screens.



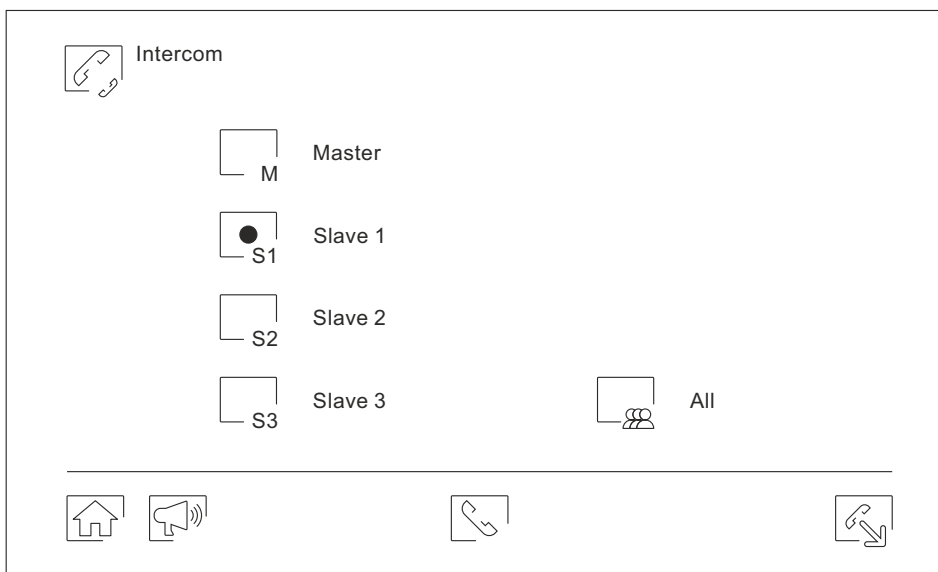

If during an intercom process with another guard unit a call is received from the door panel, the intercom process will be terminated, and the door panel call will be received on the guard unit or corresponding monitor.

Use icon  to return to the main menu.



Internal intercom.

Select the monitor you wish to communicate with. The monitor that appears selected by default is your own. You will find information about the address of the monitor in the 'About' menu (see p. 12). If you select the 'All' option, the rest of the monitors will receive the call, with communication established with the first one that answers.

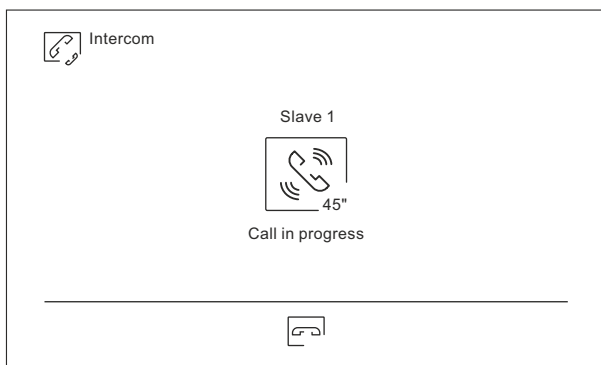

To make a call, press icon , and the 'Call in progress' message will appear on the screen. The monitor(s) that receives the call will display the 'Incoming call' message, followed by the monitor making the call. To cancel the call, press icon , and the 'Communication completed' message will appear. To establish communication, press icon  or (lift the handset), communication will end after 90 seconds or when icon  is pressed or (hang up the handset only if communication has been established by lifting the handset).

Guard unit making the call

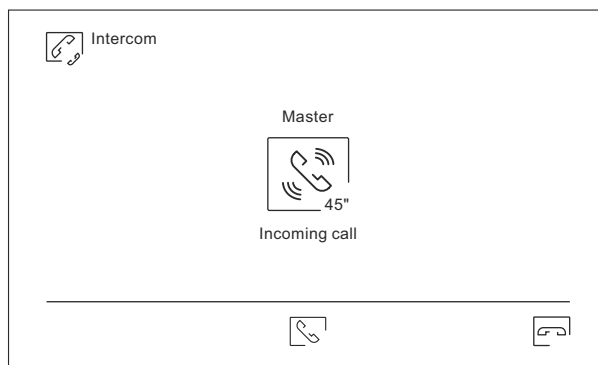

Guard unit receiving the call



To perform an internal broadcast process, select the guard unit to establish communication and then press icon ; it is now possible to talk, listen, and raise and lower the communication volume from each of these 2 guard units. Communication will last for 90 seconds or until icon  is pressed.

Continued from previous page.



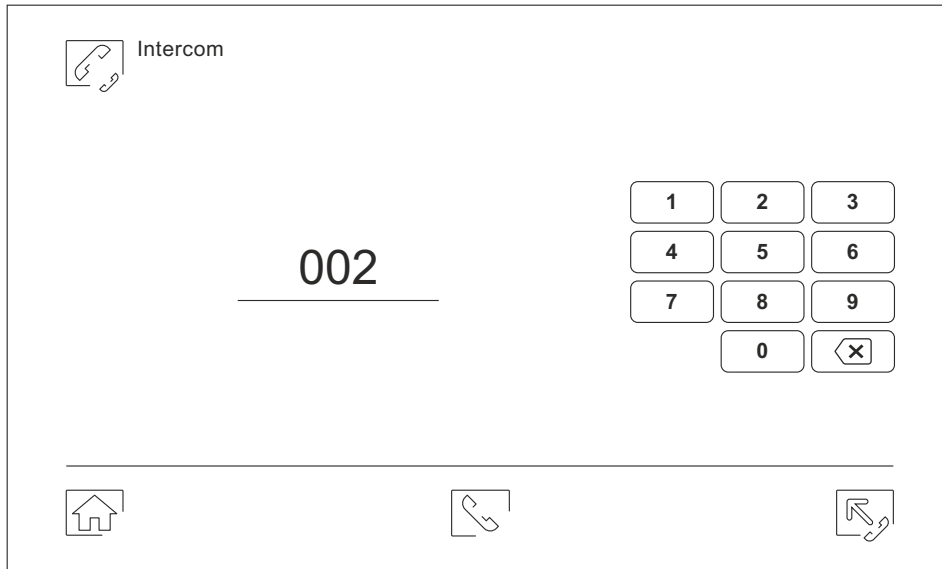

CE-ART 7W/G2+ GUARD UNIT

Intercom menu



External intercom.

Enter the code of the apartment with which you wish to communicate using the keypad.

To make a call, press icon , and the 'Call in progress' message will appear on guard unit screen. The master monitor of the apartment called will display the 'Incoming call' message, followed by the "guard" message. To cancel the call, press icon , and the 'Communication completed' message will appear. To establish communication, press icon  or (lift the handset); communication will end after 90 seconds or when icon is  pressed or (hang up the handset only if communication has been established by lifting the handset).

Note: If you pick up the handset when the display is idle (display off), the 'External Intercom' screen is accessed directly.

Guard unit making the call

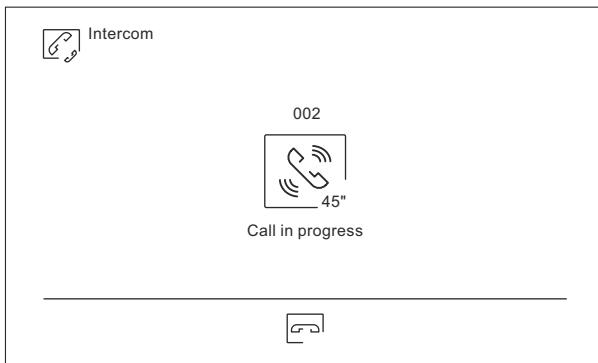

Apartment monitor 002 receiving the call

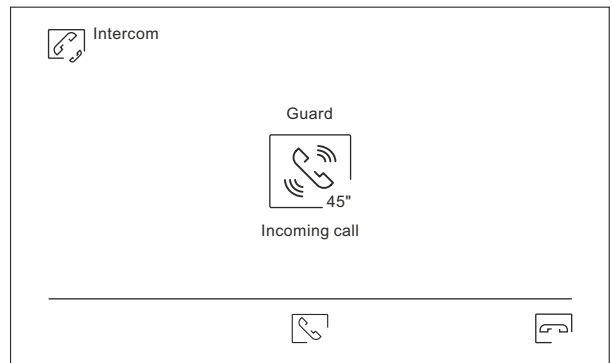

Guard unit in communication

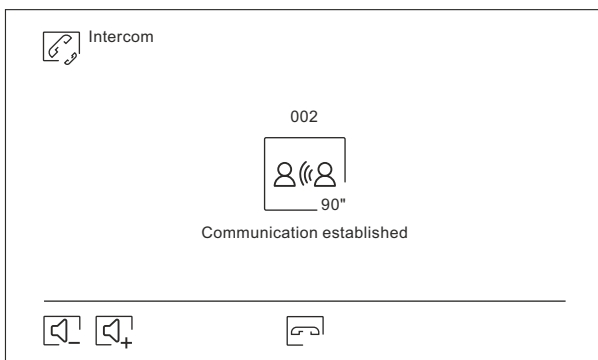

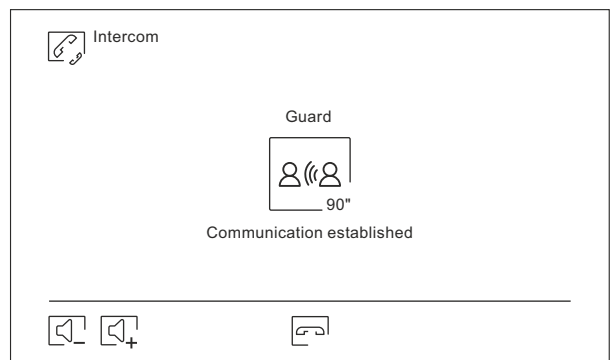

Apartment monitor 002 in communication



CE-ART 7W/G2+ GUARD UNIT

Recordings menu

This menu displays the list of images saved in the guard unit or on the SD card if inserted. Press icon  to access the video recordings saved on the SD card and icon  to return to the images list. There are 10 recordings per page and the number of pages is shown at the bottom of the screen. Use the scroll arrows to access the rest of the pages.

Symbol  indicates that the recording has not been displayed.

Use icon  to return to the main menu.

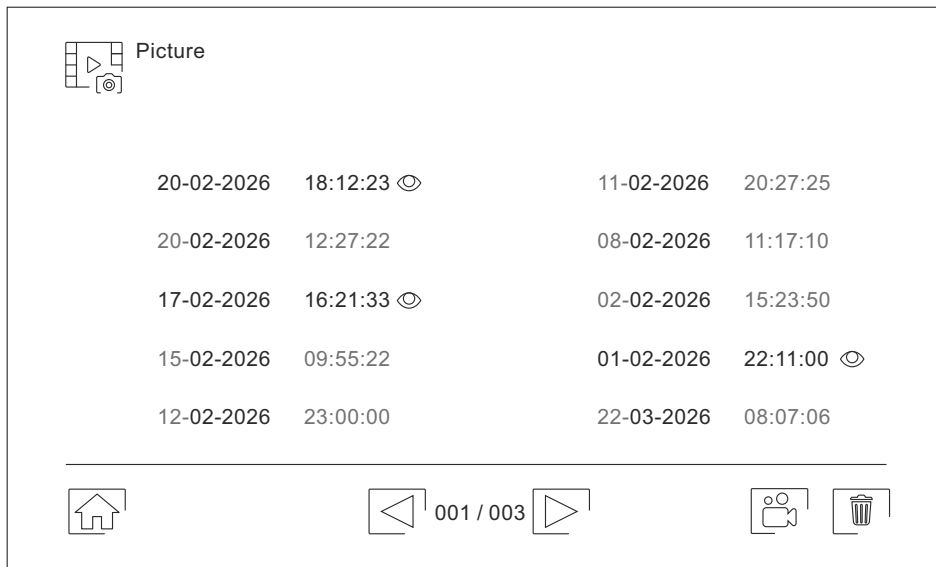

To delete one or more recordings from the list, use icon . Press on the recordings you wish to delete or use icon  to select all of them. Confirm your selection using icon : a warning screen will request your final confirmation.

Use icon  to return to the image recordings list.

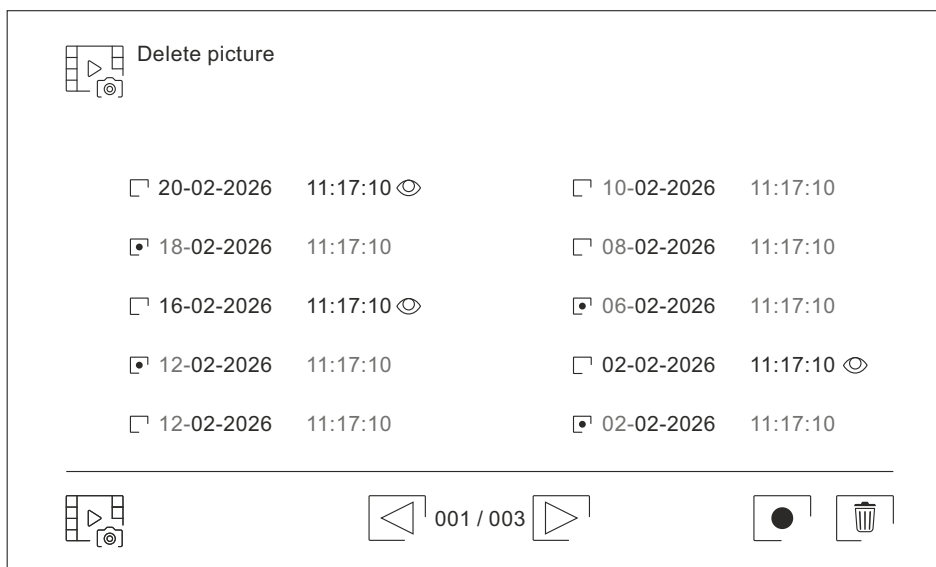





Continued from previous page.

CE-ART 7W/G2+ GUARD UNIT

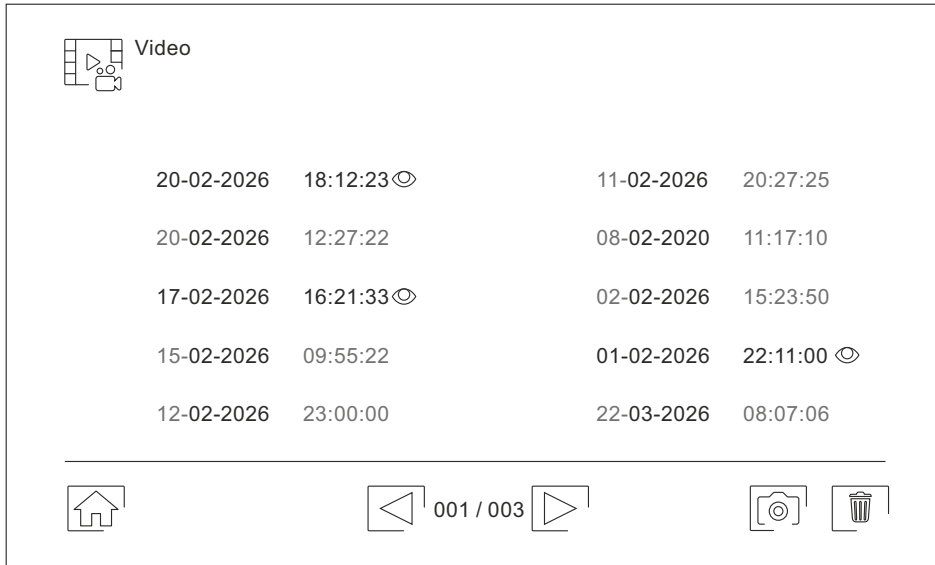
Recordings menu

Press icon  to access the video recordings.



To delete one or more recordings from the list, use icon . Press on the recordings you wish to delete or use icon  to select all of them. Confirm your selection using icon : a warning screen will request your final confirmation.





Use icon  to return to the video recordings list.



Continued from previous page.





CE-ART 7W/G2+ GUARD UNIT

Recordings menu

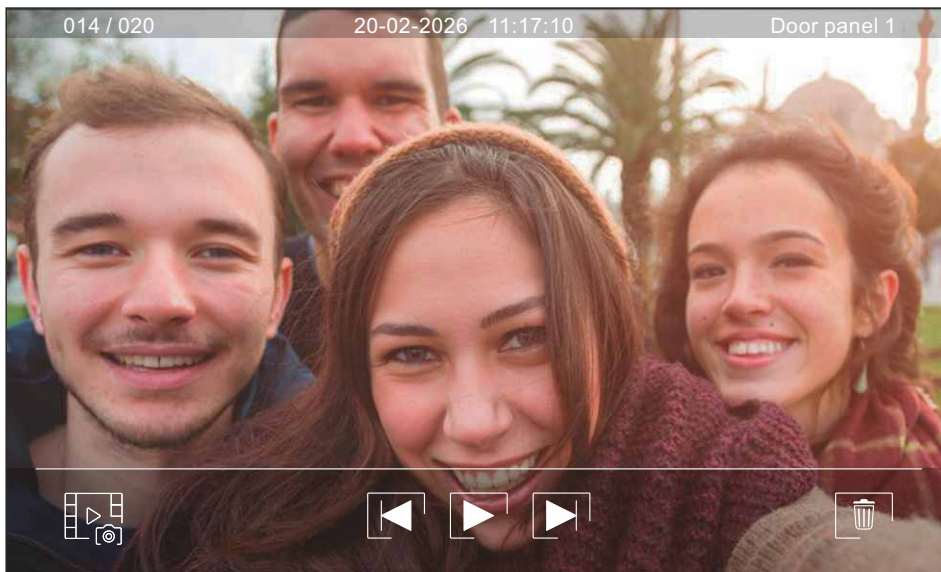
To view an image recording, select it in the list. The recording will be displayed full screen. Use the scroll arrows to display the next  or previous  recording. From this screen, you can also delete the recordings individually, which always requires your confirmation. Use icon  to play the images in sequence; press icon  to stop image playback.

Use icon  to return to the image recordings list.



To view a video recording, select it in the list. The recording will be displayed full screen. Use the scroll arrows to display the next  or previous  recording. From this screen, you can also delete the recordings individually, which always requires your confirmation. Use icon  to start playback of the video selected; press icon  to stop video playback.

Use icon  to return to the recordings list.



CE-ART 7W/G2+ GUARD UNIT

Lost call screen



Show the list of lost calls made to the central guard unit from apartments or door panels, indicating the call code, number of the apartment, name of the resident, date and time of when the call. Allows you to answer and delete from the list of lost calls (recorded in the unit's memory, maximum of 100 lost call records).

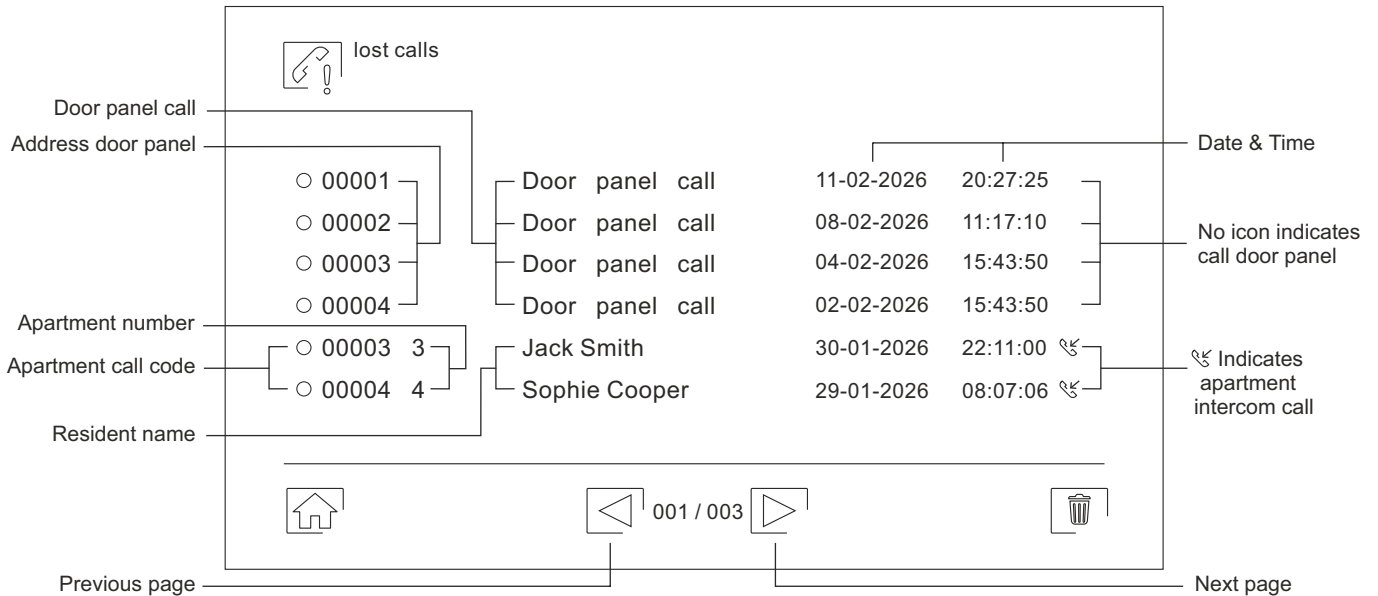

To answer the lost call of an apartment, press on the register displayed on the screen "00003" detailed as (apartment call code) or "Jack Smith" detailed as (resident name), and the message "Call in progress" will appear on the screen of the guard unit. The master monitor of the apartment called will display the message "Incoming call", followed by guard unit that makes the call. If you wish to cancel the call, press the icon [Handset] and the message "Communication finished" will appear. To establish communication, press the icon [Handset] (lift the handset), the communication will end after 90 seconds or by pressing the icon [Handset] or (hang up the handset only if communication has been established by lifting the handset).

Guard unit making the call

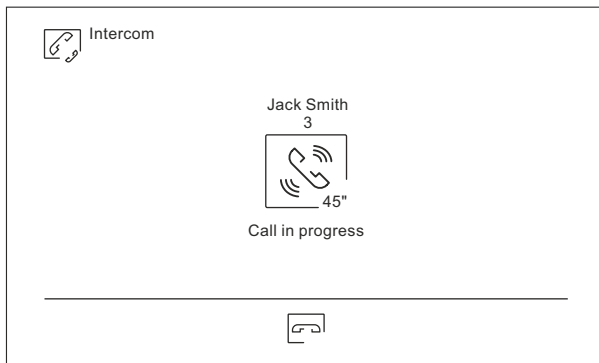

Apartment monitor 00003 receiving the call

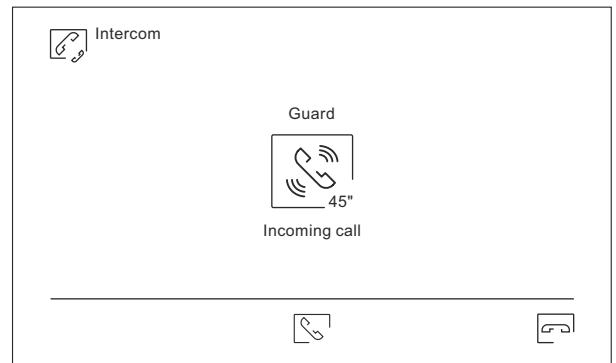

Guard unit in communication

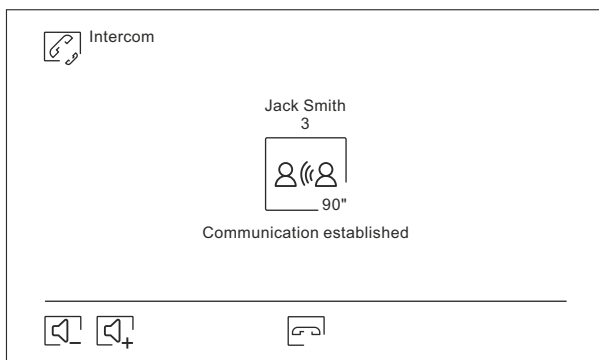



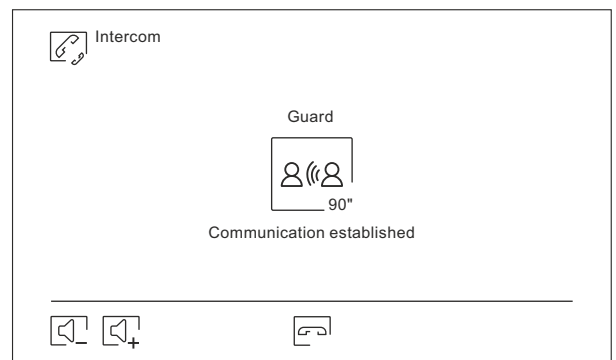

Apartment monitor 00003 in communication



Continued from previous page.
CE-ART 7W/G2+ GUARD UNIT

Lost call screen

To answer the lost call of a door panel, press on the register displayed on the screen "00001" detailed as (address door panel) or (door panel call) see page 21, making an video-spy on the selected door panel. To establish communication, press the icon  (lift the handset), the communication will end after 90 seconds or by pressing the icon  or (hang up the handset only if communication has been established by lifting the handset). To open door  or  of the door panel, press the corresponding icon on the screen during the call or communication processes: one press will activate the lock release for 3 seconds.

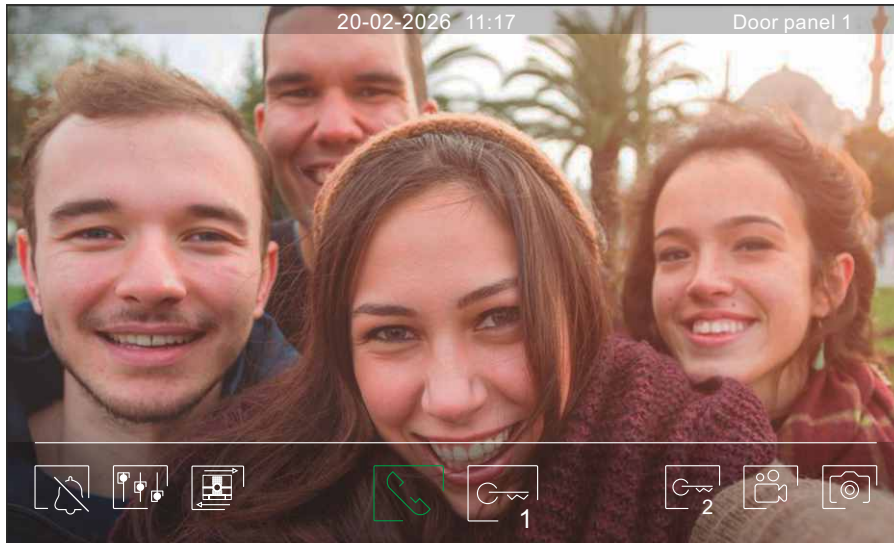

To delete one or more recordings from the list, use the icon . Press on the register of the lost calls you want to delete. Confirm your selection by pressing the icon .

Use icon  to return to main menu.



Address call codes examples displayed on guard unit of the apartments:

Installation of 1 Building: Guard unit of (Building):

- Call code "00001" of the apartment 1.
- Call code "00010" of the apartment 10.
- Call code "00025" of the apartment 25.
- Call code "00032" of the apartment 32.

Installation of more than 1 Building: guard unit de (general door panels):

- Call code "01001" of the building 1 (apartment 1).
- Call code "02010" of the building 2 (apartment 10).
- Call code "06025" of the building 6 (apartment 25).
- Call code "32032" of the building 32 (apartment 32).

CE-ART 7W/G2+ GUARD UNIT

Contacts list with 2nd call (guard unit of "building")



Show the residents contacts list in the building, indicating the resident name/ flat and apartment call code. Press on one of the contacts to make an intercom call to the selected apartment. (required to insert micro SD card with file "ART7W-G2+ NAMELIST.CSV", see page 25 for configuration). **Note: If you pick up the handset when the display is idle (display off), the 'External Intercom' screen is accessed directly.**

Apartment call code	Mrs Emily Flat 1 11			Mr Jake Flat 2 12		
Resident name (max. 16 characters)	Mr Liam Flat 3 13			Mrs Mia Flat 4 14		
	Mrs Ava Flat 5 15			Mr Jake Flat 6 16		
	Mr James Flat 7 17			Mrs Susan Flat 8 18		
	Mrs Olivia Flat 9 19			Mr Daniel Flat 10 20		

Fast forward previous pages

Previous page

Fast forward Next pages

Next page

To make an intercom call to wished apartment, press on "apartment call code" or "resident name" of the contacts displayed on the screen(s), and the "call in progress" message will appear on guard unit screen. The master monitor and the slave monitor S1 (if any) of the apartment called will display the 'Incoming call' message, followed by the "guard" message. To cancel the call, press icon , and the "Communication finished" message will appear. To establish communication, press icon or (lift the handset); communication will end after 90 seconds or when icon is pressed or (hang up the handset only if communication has been established by lifting the handset). **Note: If you pick up the handset when the display is idle (display off), the 'External Intercom' screen is accessed directly.**

Guard unit making the call

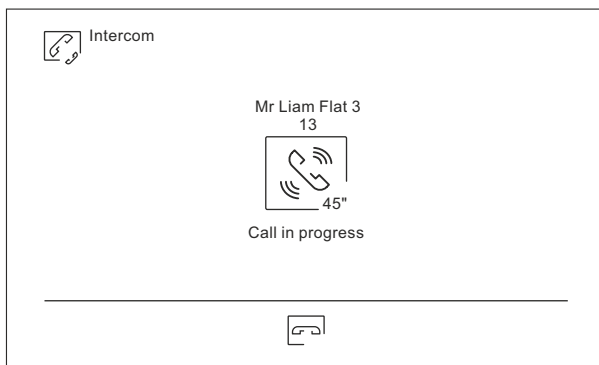

Apartment monitor 2 receiving the call

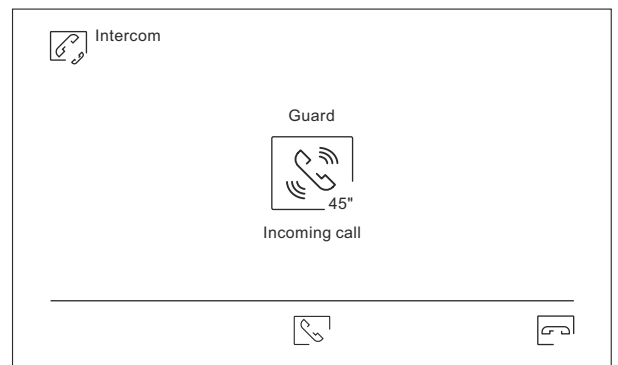

Guard unit in communication

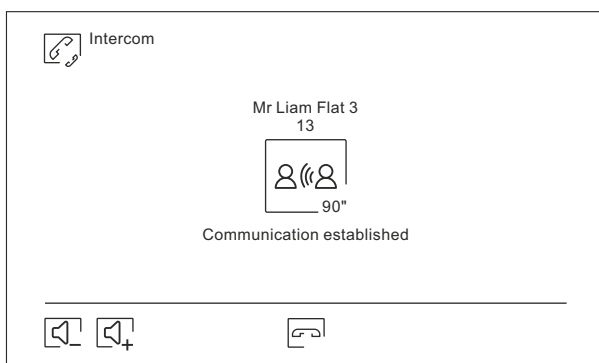

Apartment monitor 2 in communication

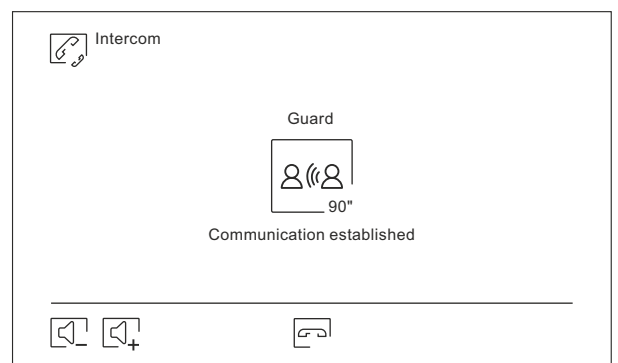

Continued overleaf

Continued from previous page.

CE-ART 7W/G2+ GUARD UNIT

Contacts list (guard unit of "general door panels")



Show the residents contacts list in the installation, indicating the building number, resident name/flat and the apartment call code. Press on one of the contacts to make an intercom call to the selected apartment (required to insert micro SD card with file "ART7W-G2+ NAMELIST.CSV", see page 25 for configuration "max. 2000 contacts/ 200 pages"). **Note: If you pick up the handset when the display is idle (display off), the 'External Intercom' screen is accessed directly.**

Apartment call code	Resident name (max. 16 characters)
Building 1 Flat 1 11	Building 1 Flat 2 12
Building 2 Flat 1 21	Building 2 Flat 2 22
Building 3 Flat 1 31	Building 3 Flat 2 32
Building 4 Flat 1 41	Building 4 Flat 2 42
Building 5 Flat 1 51	Building 5 Flat 2 52

To make an intercom call to wished apartment, press on "apartment call code" or "resident name" of the contacts displayed on the screen(s), and the "call in progress" message will appear on guard unit screen. The master monitor and the slave monitor S1 (if any) of the apartment called will display the 'Incoming call' message, followed by the "guard" message. To cancel the call, press icon , and the "Communication finished" message will appear. To establish communication, press icon or (lift the handset); communication will end after 90 seconds or when icon is pressed or (hang up the handset only if communication has been established by lifting the handset).

Guard unit making the call

Apartment monitor 21 receiving the call

Guard unit in communication

Apartment monitor 21 in communication

Continued overleaf

Continued from previous page.

CE-ART 7W/G2+ GUARD UNIT

Configuration "ART7W-G2+ NAMELIST.CSV" file (guard unit of "Building")

Configure in "ART7W-G2+ NAMELIST.CSV" file, only the fields of the following parameters: Backbone, System address, Resident name and call code.

Important: -Only configure the fields of the following parameters and neither modify row no. 1 nor delete columns.
-Do not change the description or extension of the "ART7W-G2+ NAMELIST.CSV" file.

Configuration example for guard unit (Building)

	A	B	C	D
Row nº1	Backbone	System address	Resident name	Call code
Fields	0	1	Mrs Emily Flat 1	11
Fields	0	2	Mr Liam Flat 2	21
Fields	0	3	Mrs Ava Flat 3	31
Fields	0	4	Mr James Flat 4	41
Fields	0	5	Mrs Olivia Flat 5	51
Fields	0	6	Mr Jake Flat 6	61
Fields	0	7	Mrs Mia Flat 7	71
Fields	0	8	Mr Jake Flat 8	81
Fields	0	9	Mrs Susan Flat 9	91
Fields	0	10	Mr Daniel Flat 10	10

Note: "Backbone" fields with only one building in the installation must be "0"

Configuration "ART7W-G2+ NAMELIST.CSV" file (guard unit of "General door panels")

Configure in "ART7W-G2+ NAMELIST.CSV" file, only the fields of the following parameters: Backbone, System address, Resident name and call code.

Important: -Only configure the fields of the following parameters and neither modify row no. 1 nor delete columns.
-Do not change the description or extension of the "ART7W-G2+ NAMELIST.CSV" file.

Configuration example for guard unit (General door panels)

	A	B	C	D
Fila nº1	Backbone	System address	Resident name	Call code
Fields	1	1	Building 1 Flat 1	11
Fields	1	2	Building 1 Flat 2	12
Fields	2	1	Building 2 Flat 1	21
Fields	2	2	Building 2 Flat 2	22
Fields	3	1	Building 3 Flat 1	31
Fields	3	2	Building 3 Flat 2	32
Fields	4	1	Building 4 Flat 1	41
Fields	4	2	Building 4 Flat 2	42
Fields	5	1	Building 5 Flat 1	51
Fields	5	2	Building 5 Flat 2	52

CLEANING THE MONITOR

- Do not use solvents, detergents or cleaning products that contain acids, vinegar or abrasive components.
- Use a soft damp cloth (not wet) that sheds no fibres.
- Always wipe the monitor in the same direction, from top to bottom.
- After cleaning the monitor, remove any moisture with a soft dry cloth that sheds no fibres.

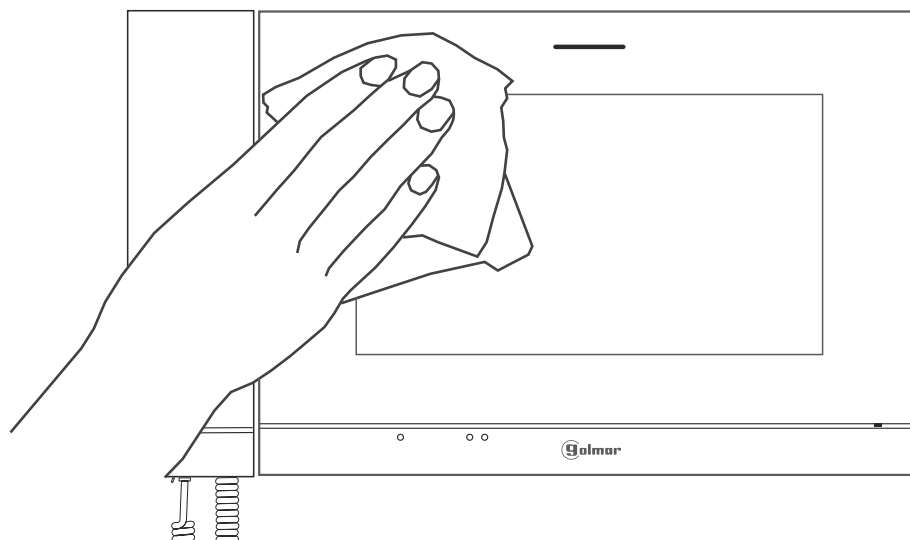



SPECIAL CODES

The enabling of some functions, as well as the modification of some factory parameters, can be carried out by entering special codes. To do so, the installer menu must be accessed from the monitor. Go to the 'About' screen in the settings menu (p. 12) and press five times on icon  in the top left of the screen to bring up a keyboard to enter the codes.

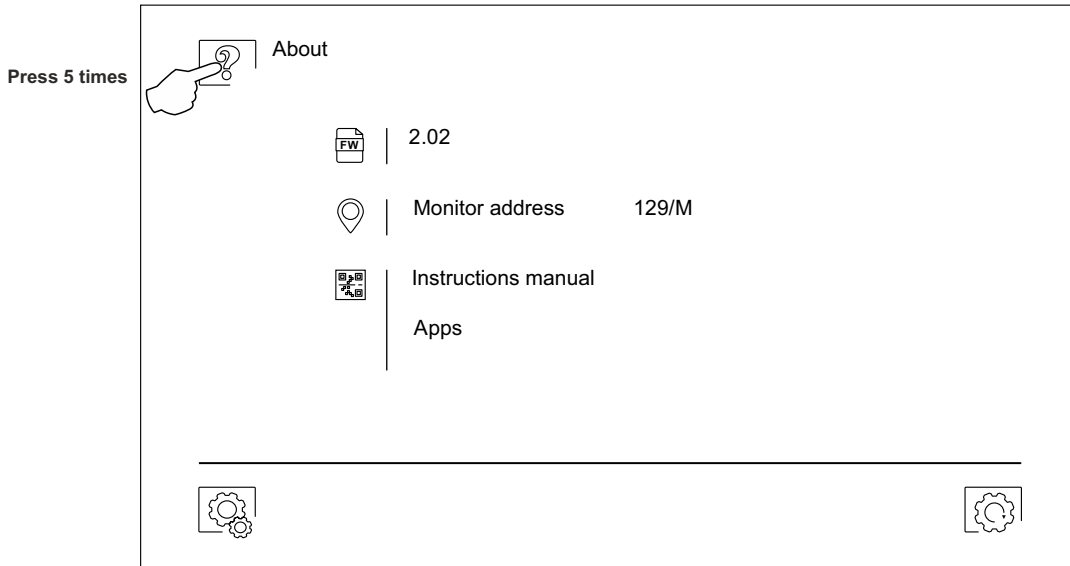
“About” screen



The 'special codes' screen will then be displayed. The codes must be entered one by one and validated using icon . If the code entered is valid, the 'OK' message will be displayed; if not, the 'ERROR' message will be displayed.

Use icon  to return to the 'About' screen.

'Special codes' screen

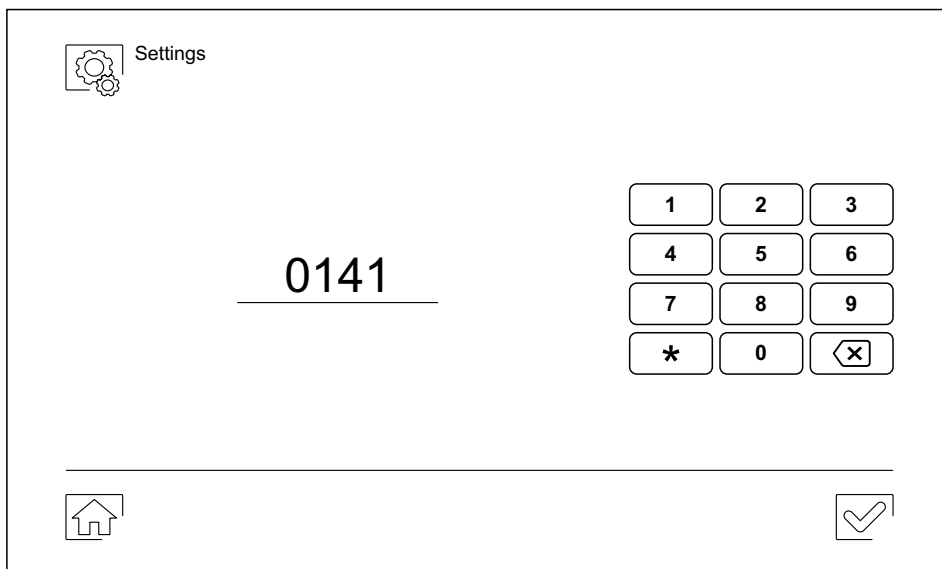

Continued from previous page.

SPECIAL CODES

To define whether the guard unit is master, slave 1, slave 2 or slave 3.

<u>Master</u>	<u>Slave 1</u>	<u>Slave 2</u>	<u>Slave 3</u>	<u>Factory setting</u>
0550	0551	0552	0553	0550 (master)

Activate/deactivate the hidden start/stop communication and door opening button on a monitor (hidden buttons located above raised dots ●/●● for the visually impaired).

<u>Activate</u>	<u>Deactivate</u>	<u>Factory setting</u>
0461	0460	0460 (deactivate)

Activate/deactivate ('power indicator' notification icon), configure on a guard unit.

<u>Activate</u>	<u>Deactivate</u>	<u>Factory setting</u>
0471	0470	0471 (activate)

Call capture mode from the door panel, configure only in the master guard unit.

	<u>Activate</u>	<u>Deactivate</u>	<u>Factory setting</u>
Capture door panel 1	1711	1710	1710
Capture door panel 2	2711	2710	2710
Capture door panel 3	3711	3710	3710
Capture door panel 4	4711	4710	4710

Night mode (with the capture mode activated, the door panel that makes the call if it detects "low ambient light" calls the apartment directly), configure only in the master guard unit.

<u>Activate</u>	<u>Deactivate</u>	<u>Factory setting</u>
0591	0590	0590

Video sources available on a guard unit (configure only on the master guard unit).

	<u>Visible</u>	<u>Not Visible</u>	<u>Factory setting</u>
Door panel 1	0111	0110	0111
Door panel 2	0121	0120	0120
Door panel 3	0131	0130	0130
Door panel 4	0151	0150	0150
Camera 1	0141	0140	0140
Camera 2	0181	0180	0180
Camera 3	0171	0170	0170
Camera 4	0191	0190	0190

SPECIAL CODES (GENERAL DOOR PANELS)

General door panels video sources available on a monitor (configure only on the master monitor).

	<u>Visible</u>	<u>Not visible</u>	<u>Factory setting</u>
General door panel 1	1111	1110	1111
General door panel 2	1121	1120	1120
General door panel 3	1131	1130	1130
General door panel 4	1151	1150	1150
General camera 1	1141	1140	1140
General camera 2	1181	1180	1180
General camera 3	1171	1170	1170
General camera 4	1191	1190	1190

-Important: (see compatibility of monitors/ telephones with the guard unit on page 2).

Continued from previous page.

SPECIAL CODES

Allows the video of a door panel or camera to be displayed on the monitor during intercommunication with the master guard unit, configured only in the master guard unit.

- Does not show video 0610 (factory default)
- Show video Door panel 1 0611
- Show video Door panel 2 0612
- Show video Door panel 3 0613
- Show video Door panel 4 0615
- Show video Camera 1 0614
- Show video Camera 2 0618
- Show video Camera 3 0617
- Show video Camera 4 0619

-Important: (see compatibility of monitors/ telephones with the guard unit on page 2).

Allows you to display the icon  for the management of the hidden codes of the Soul Access door panel with (cV07 and later), configure only up to the master guard unit (see page 10).

<u>Activate</u>	<u>Deactivate</u>	<u>Factory setting</u>
0801	0800	0800 (deactivate)

Permite mantener la pantalla activada durante 30 minutos:

<u>Activate</u>	<u>Deactivate</u>	<u>Factory setting</u>
0631	0630	0630 (deactivate)

INSTALLATION DIAGRAM WITH GUARD UNIT OF (BUILDING):

Video door entry system with 31 monitor ART 7W/G2+, 1 CE-ART 7W/G2+, 8 distributors D4L-G2+ & Golmar d.c lock release.

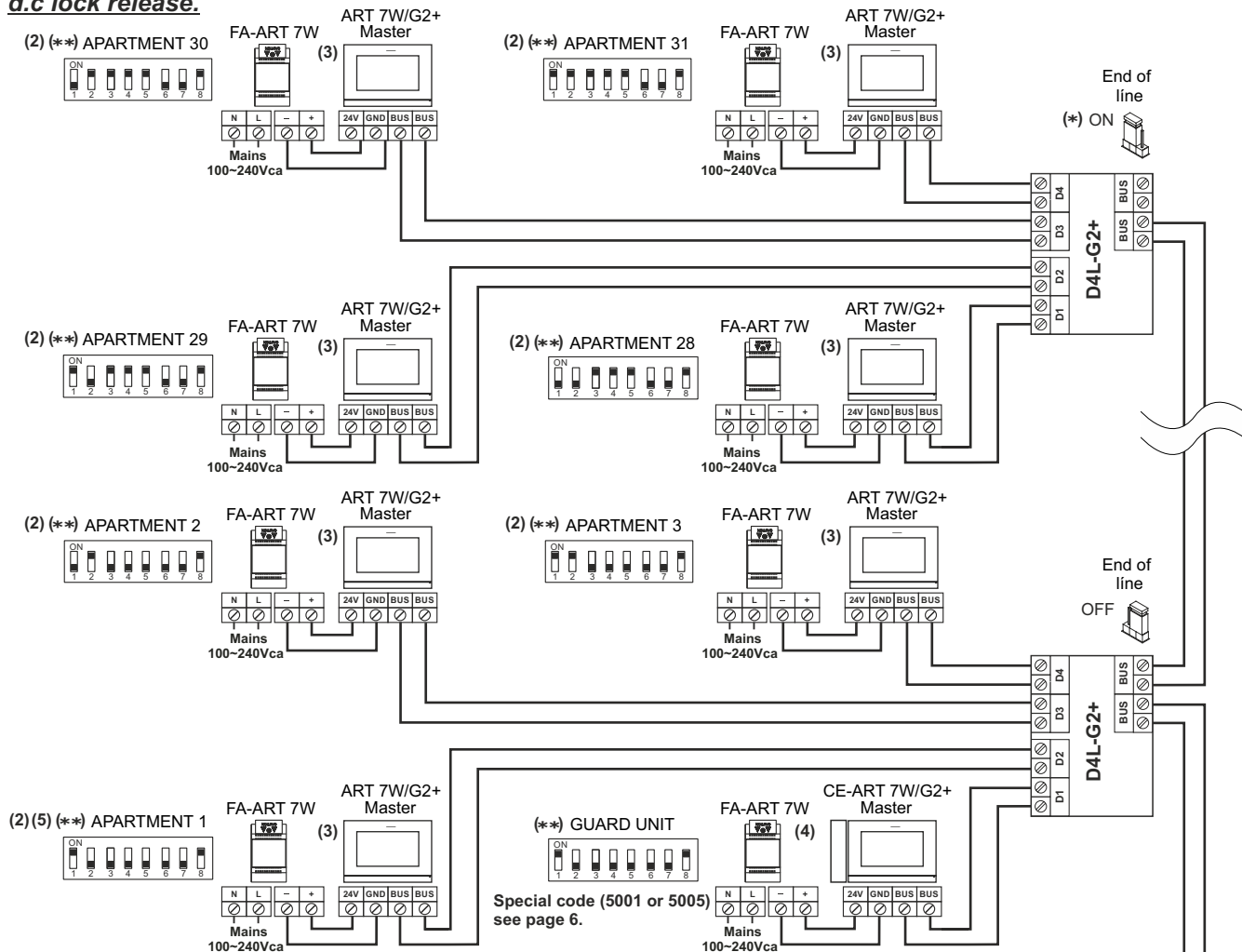

Distances and cross-sections:

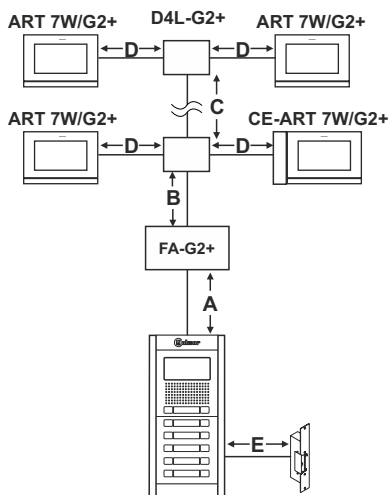

Cable	A	B	C	D	B+C+D	E
RAP-GTWIN/HF 2x1mm ²	80m	80m	80m	30m	190m	15m

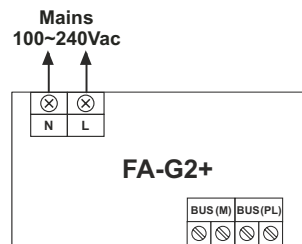

Access door panel

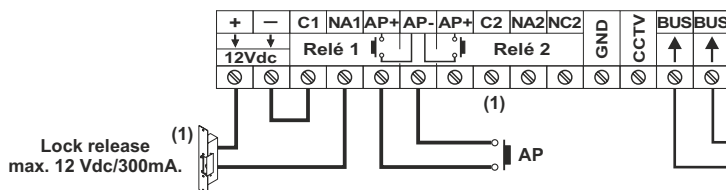
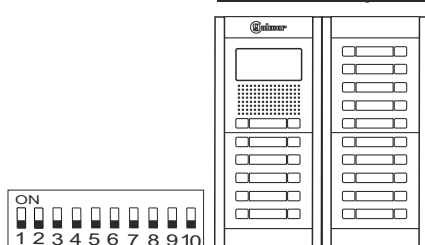

(*) Set to ON the end of line in the last distributor.

(**) Configure the end of line in the last monitor/guard unit. Dip 8 to On.

Important:

- (1) For a.c. lock release, a second lock release or more than one access door panel (see "T632 G2+ SE" manual, page 50 to 52).
- (2) For more information of the ART 7W G2+ monitor, see the quick guide that is attached with its corresponding product & compatibility with guard unit on page 2.
- (3) ART 7W/G2+ monitor with WiFi activated (only the master monitor of each apartment) FA-ART 7W power supply unit required.
- (4) CE-ART 7W/G2+ guard unit with WiFi activated (only the master guard unit) FA-ART 7W power supply unit required.
- (5) During the configuration of the guard unit of (building), see page 6 to configure the address of the monitor(s) of apartment 1.

INSTALLATION DIAGRAM WITH GUARD UNIT OF (GENERAL DOOR PANELS):

Installation of video door entry system with 3 buildings, 96 monitors (serie ART 4 / ART 7W), 1 CE-ART 7W/G2+ & 3 RD-G2+ "block mode".

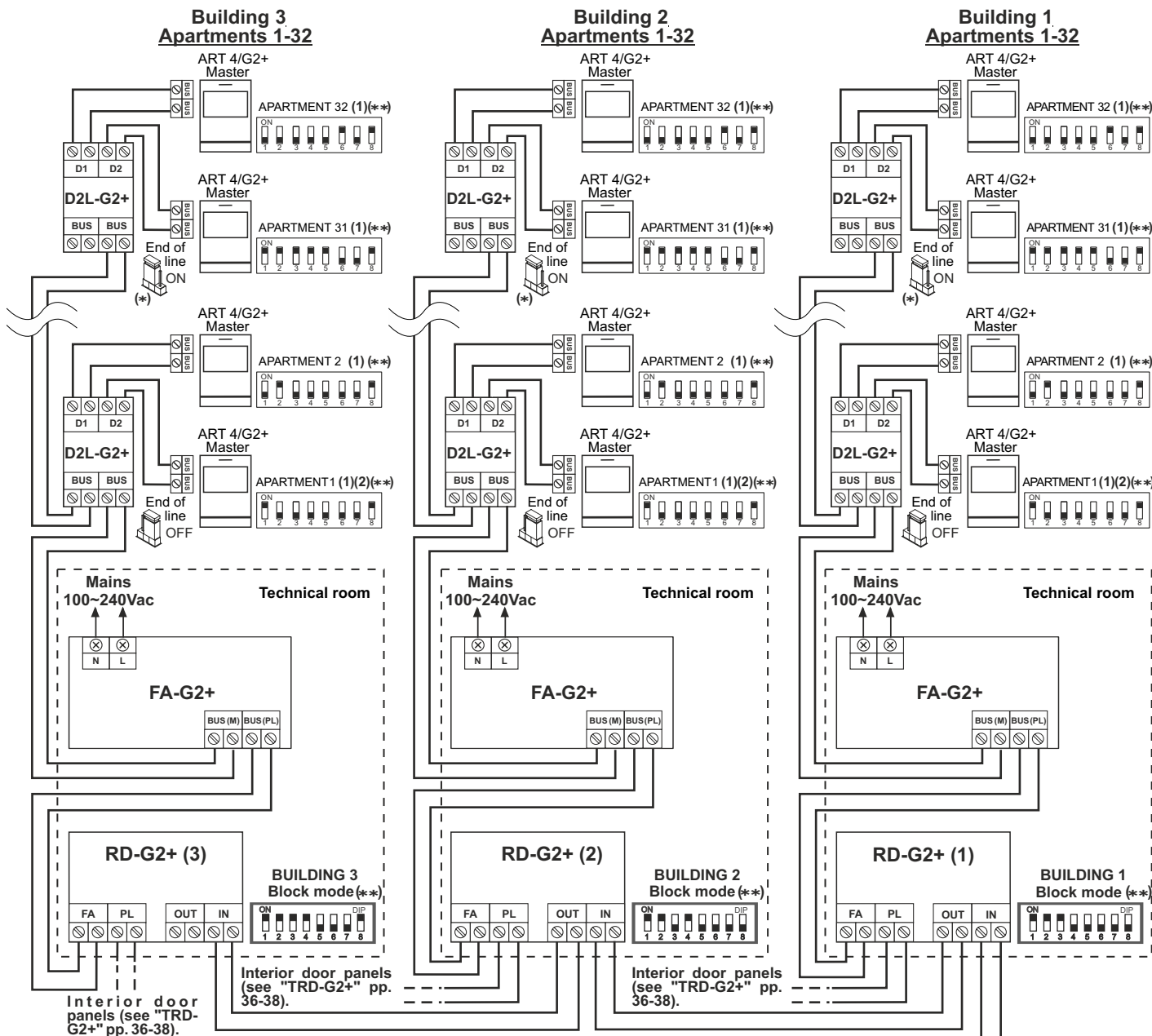

Important: (Installation with ART 7W monitors in apartments with WiFi activated)

Only the master guard unit & master monitor of each apartment with WiFi activated.
(Only for apartment, FA-ART 7W power supply unit required).

Note:

Scroll from guard unit, only general door panels & CCTV of general door panels (see page 3).

To "Bus M" of the FA-G2+ power supply (see page 36).

Note: More than 1 general door panel (see "TRD-G2+" manual, page 37 and 38)

(*) Set to ON the end of line in the last distributor.

(**) Configure the end of line in the last monitor/RD-G2+ & guard unit. Dip 8 to On.

Note: Distances and cross-sections: see page 32.

Important:

- (1) For monitor and door panel description, installation, configuration and programming, see corresponding manual. (See compatibility with guard unit on page 2).
- (2) During the configuration of the guard unit of (building), see page 7 to configure the address of the monitor(s) of apartment 1 for each one of the buildings.
- (3) CE-ART 7W/G2+ guard unit with WiFi activated (only the master guard unit) FA-ART 7W power supply unit required.

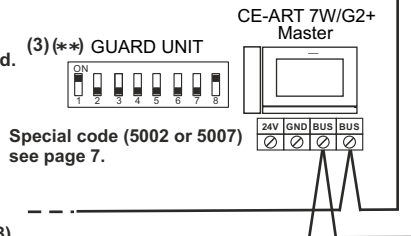

Continued from previous page.

OPERATION MODE: GUARD UNIT OF GENERAL DOOR PANELS (BLOCK MODE).

Example of installation with 4 buildings, 128 monitors, 4 RD-G2+ "block mode", 16 interior door panels and 4 general door panels.

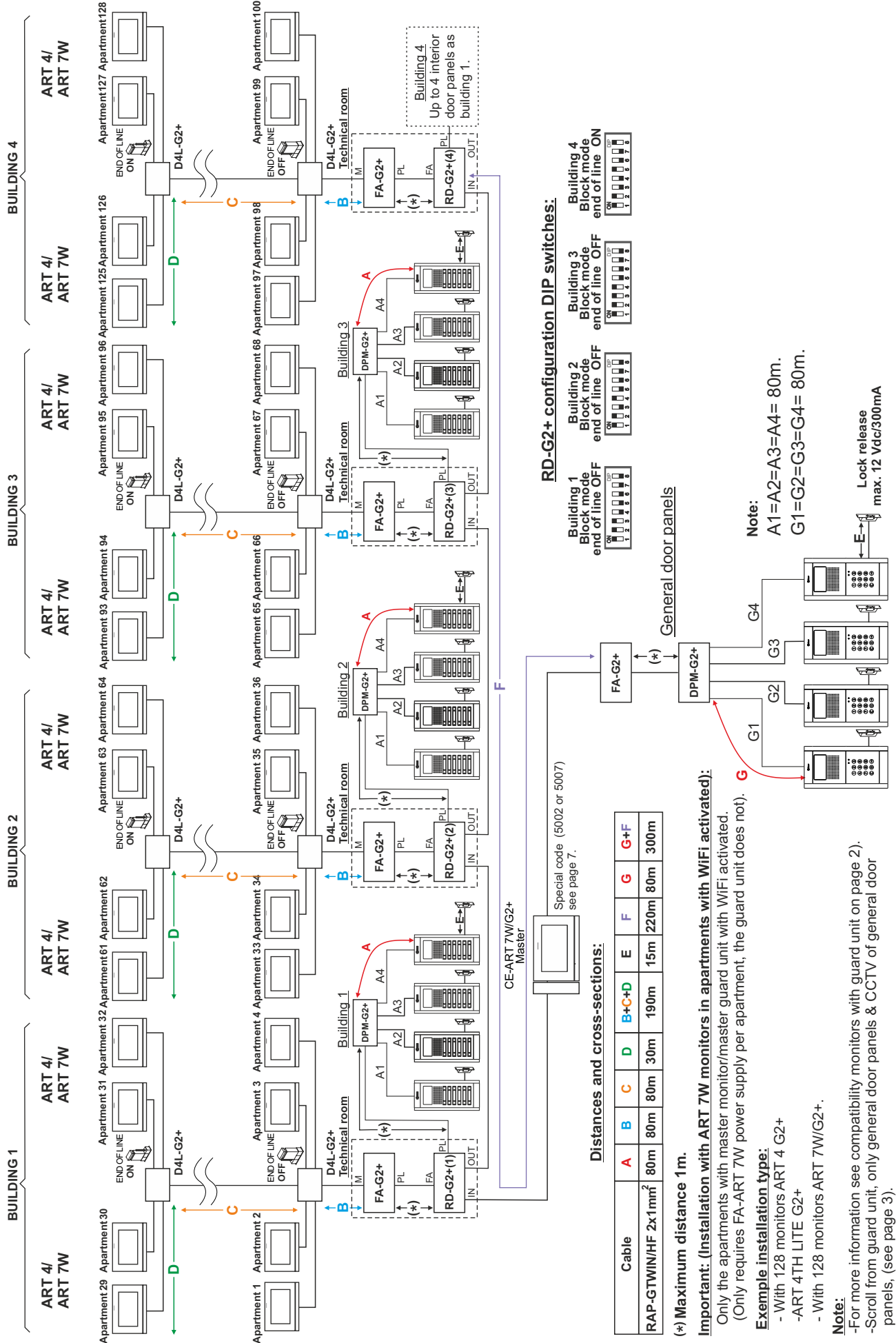

RD-G2+ configuration DIP switches:



Note:
 A1=A2=A3=A4= 80m.
 G1=G2=G3=G4= 80m.

Distances and cross-sections:

Cable	A	B	C	D	B+C+D	E	F	G	G+F
RAP-GTWIN/HF 2x1mm ²	80m	80m	80m	30m	190m	15m	220m	80m	300m

(*) Maximum distance 1m.

Important: (Installation with ART 7W monitors in apartments with WiFi activated):

Only the apartments with master monitor/master guard unit with WiFi activated.
 (Only requires FA-ART 7W power supply per apartment, the guard unit does not).

Example installation type:

- With 128 monitors ART 4 G2+
- ART 4TH LITE G2+
- With 128 monitors ART 7W/G2+.

Note:

- For more information see compatibility monitors with guard unit on page 2).
- Scroll from guard unit, only general door panels & CCTV of general door panels, (see page 3).

Lock release
 max. 12 Vdc/300mA

Continued from previous page.

OPERATION MODE: GUARD UNIT OF GENERAL DOOR PANELS (BLOCK MODE).

Example of installation with 4 buildings, 128 monitors, 4 RD-G2+ "block mode", 16 interior door panels and 4 general door panels.

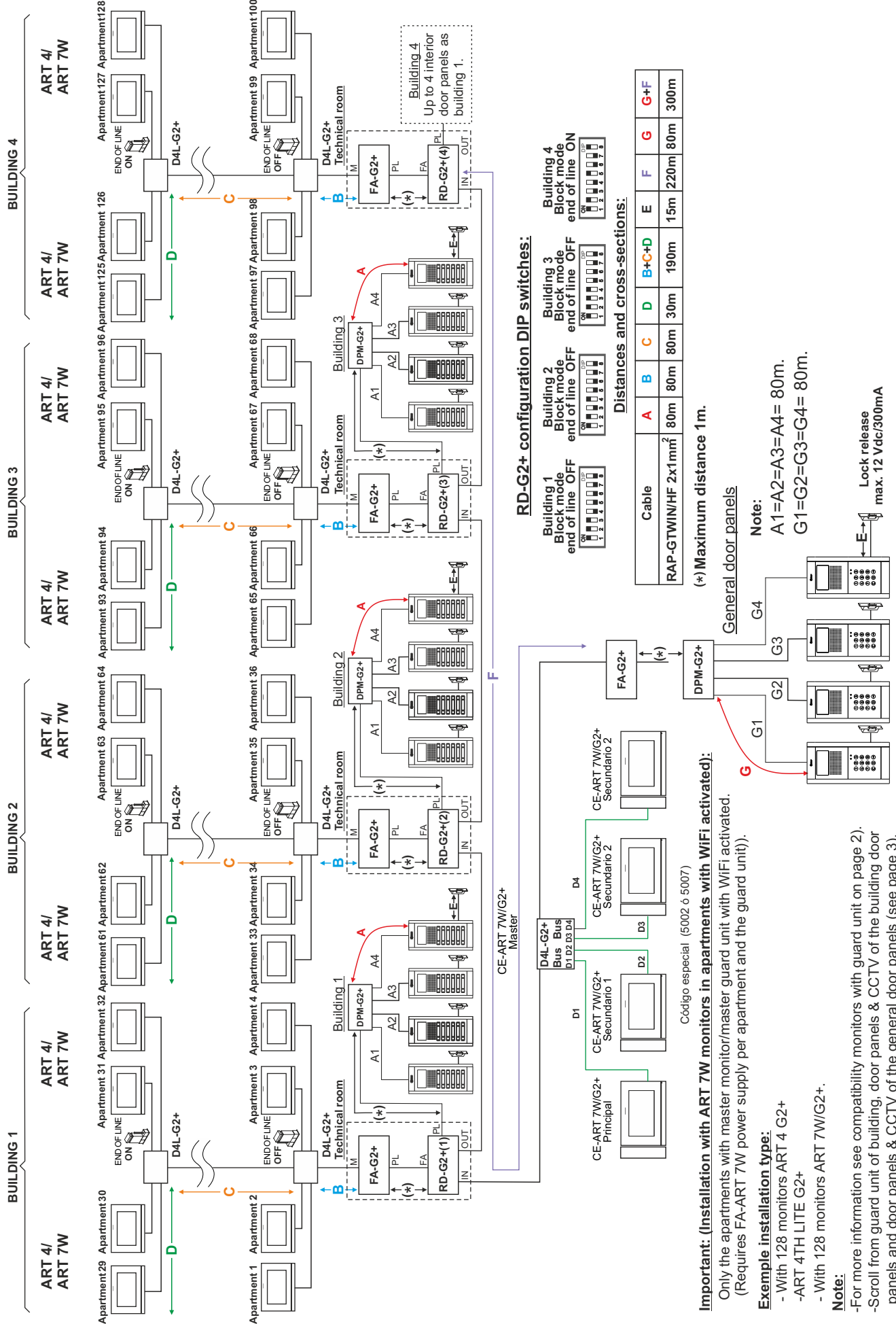

Continued from previous page.

OPERATION MODE: GUARD UNIT OF BUILDING (GENERAL DOOR PANELS "BLOCK MODE").

Example of installation with 4 buildings, 128 monitors, 4 RD-G2+ "block mode", 16 interior door panels and 4 general door panels.

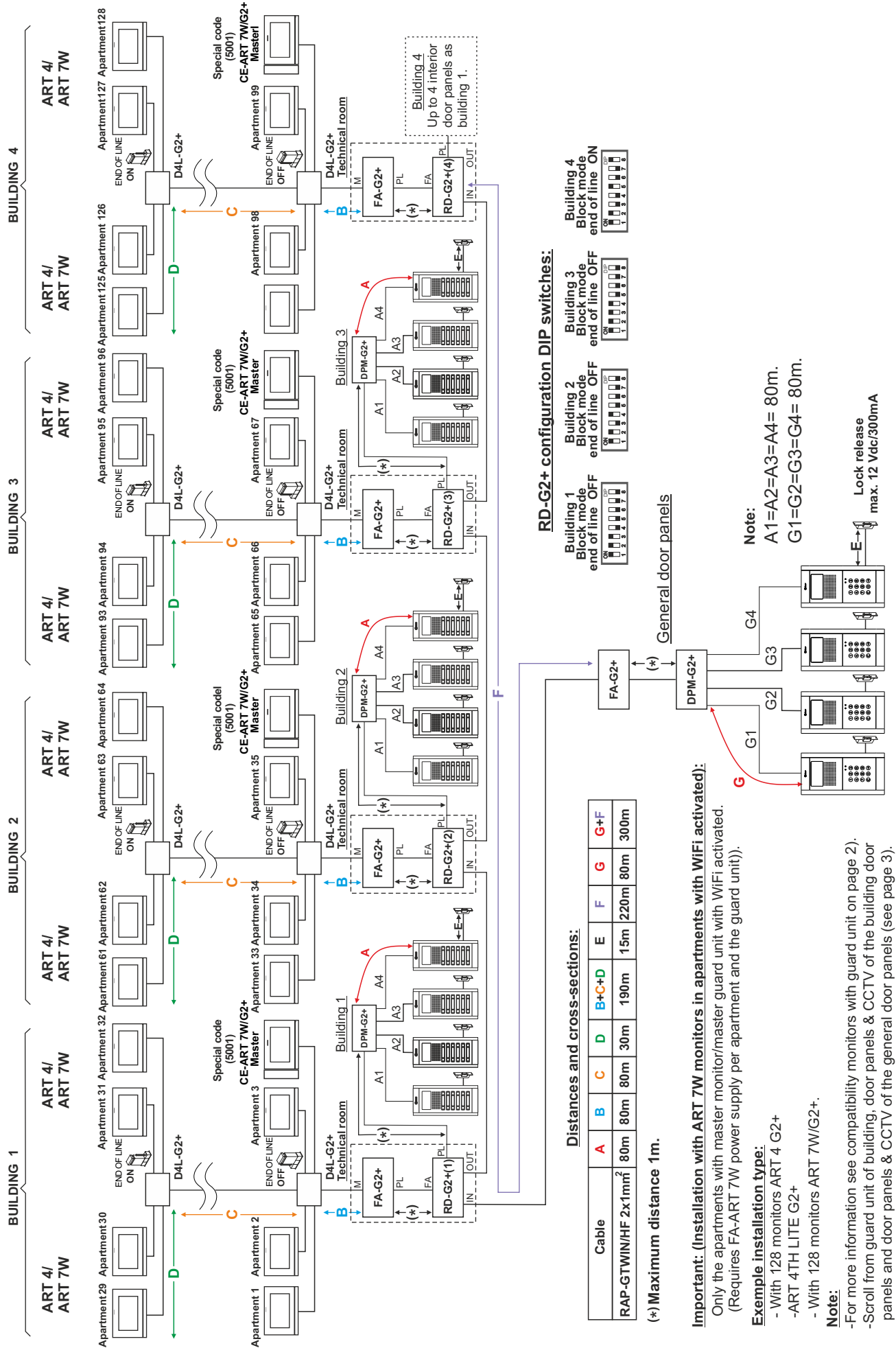

COMPLIANCE:

Este producto es conforme con las disposiciones de las Directivas Europeas aplicables respecto a Equipos de Radio **2014/53/CEE** y la Compatibilidad Electromagnética **2014/30/CEE**.

*This product meets the essentials requirements of applicable European Directives regarding Radio Equipment **2014/53/ECC** and Electromagnetic Compatibility **2014/30/ECC**.*



NOTA: El funcionamiento de este equipo está sujeto a las siguientes condiciones:

(1) Este dispositivo no puede provocar interferencias dañinas, y (2) debe aceptar cualquier interferencia recibida, incluyendo las que pueden provocar un funcionamiento no deseado.

NOTE: Operation is subject to the following conditions:

(1) This device may not cause harmful interference, and (2) this device must accept any received interference, including the ones that may cause undesired operation.



golmar@golmar.es

www.golmar.es

GOLMAR S.A.
C/ Silici, 13
08940- Cornellá de Llobregat
SPAIN



Golmar se reserva el derecho a cualquier modificación sin previo aviso.

Golmar se réserve le droit de toute modification sans préavis.

Golmar reserves the right to make any modifications without prior notice.