

# Golmar

Clip surface panel

## CLIP/G+



# INSTALLER MANUAL

[www.golmar.es](http://www.golmar.es)  
[golmar@golmar.es](mailto:golmar@golmar.es)

## INDEX

---

1. Safety, cautions and warnings.....	3
2. IP G+ system specifications.....	3
3. Clip description.....	4
4. Entry panel location.....	5
5. Configuration by panel clip.....	5
5.1 Registration of CLIP panel as a building panel.....	6
5.2 Registration of CLIP panel as an apartment panel (PCM) .....	6
5.3 Panel registration by Web Server.....	7
5.4 Settings.....	8
5.5 Access cards .....	9
5.6 SIP servers.....	9
5.7 Devices.....	10
5.8 Event log .....	11
5.9 About.....	12
6. Clip led status .....	12
7. Settings for calls.....	13
7.1 Grouped calls, separated by (,).....	13
7.2 Calls for block concierge & general concierge .....	13

## 1. SAFETY, CAUTIONS AND WARNINGS

---

- The installation and setup of this equipment must be done by an authorized installer in a suitable surface and following the current regulations.
- Do not touch the device with wet hands, or using cleaning liquids or aerosols.
- Install the device in a dry and secure area, protected against water drops or sprays.
- Avoid placing the device close to heating/cooling sources, humid or dusty areas.
- Do not cover the device ventilation openings to assure air flow circulation.
- Do not open the device cover or manipulate the monitor's electric circuit.
- Danger of electric shock.

### Declaration about compliance with Directive 2014/53/EU:

Hereby, GOLMAR S.A. declares that the radio equipment types **12325701 CLIP/G+** is in compliance with the Directive 2014/53/EU (RED), 2014/30/UE (EMC) y 2014/35/UE (Low Voltage). RFID Frequency Band: 13.56 MHz. Output power (max): 12,72 dBμA/m.

The full text of the EU declaration of conformity is available at the following internet address: <https://www.golmar.es>

## 2. IP G+ SYSTEM SPECIFICATIONS

---

- TCP/IP video intercom system with technology IP G+.
- Installation over ethernet network.
- Up to 98 blocks in one system.
- Up to 99 entry panels at each block.
- Up to 99 general panels at each installation.
- Up to 799 flats per each block.
- Up to 19 guard units for the general compound and 9 guard units at each block.
- Up to 256 ONVIF cameras and 30 SIP servers.

### 3. CLIP DESCRIPTION

A. Front:



- ① Speaker
- ② Camera
- ③ LED RFID
- ④ Button call
- ⑤ SmartPrompt function
- ⑥ Microphone

B. Back:

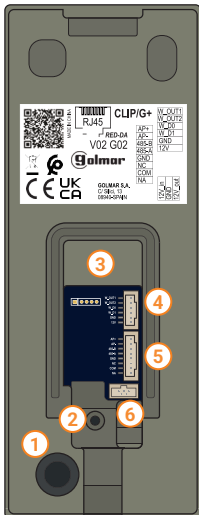

- ① Tamper
- ② Button reset to factory
- ③ UTP cable tunnel
- ④ Wiegand connector
- ⑤ Door opener connector
- ⑥ Power supply connector

(i) The order of connectors appears in the label placed close to the connectors.

- W\_OUT1 refers to the Data 0 connection wire (Wiegand output for connecting to a controller).
- W\_OUT2 refers to the Data 1 connection wire (Wiegand output for connecting to a controller).
- W\_D0 refers to the Data 0 connection wire (Wiegand input for connecting a slave reader to the panel).
- W\_D1 refers to the Data 1 connection wire (Wiegand input for connecting a slave reader to the panel).

## 4. ENTRY PANEL LOCATION

1. Avoid exposing the panel to backlighting from light sources for optimal picture quality.

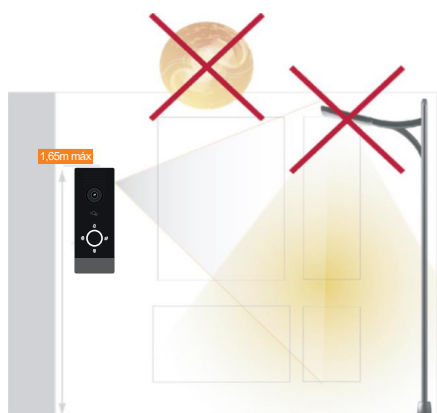

2. Place the top of the panel at a height of 1,65 m for a correct viewing of the screen.

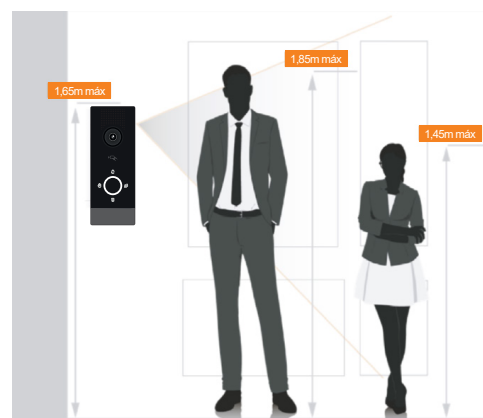

3. Use the panel bracket, so that the panel is at the above mentioned height. Place it in a flat surface which allows a good fit of the panel to the wall.



4. Accessory: panel bracket surface without rainshield.



## 5. CONFIGURATION BY PANEL CLIP

Important initial configuration notes:

One of the door panels of the installation is in charge to manage the system (master panel). When starting for the first time, the panel will request the different registration parameters to be entered.

The panel can be configured in three ways:

- Through the TACT button on the back of the panel (see section 5.1 for details).
- Through the webserver (see section 6 for details).
- By using SCT software (download the software and its manual in the downloads area of the panel).

We strongly recommend to configure the system using the Software SCT "System configuration Tool".

**FW NOTE:** It is important to verify, that all the devices are using compatible FW. SCT makes easy the FW update and FW verification.

### 5.1 Registration of CLIP panel as a building 1 panel 1

For the first step, you must quickly press the button on the back of the panel five times (see figure). The push button LED will flash three times to confirm that the panel has been programmed and is ready to pair with the monitor.

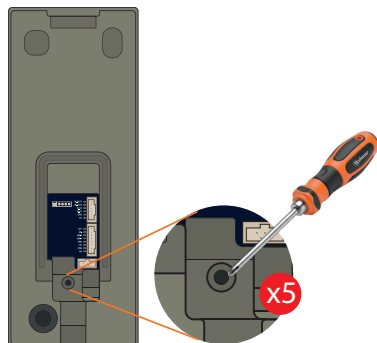

This step is used to configure the Clip panel as the master device of our installation and assign it the IP address 10.0.14.9.

**Important note:** The 5 presses behind the panel should only be performed if it is the only Clip panel in the installation. If there are additional panels of this model, please refer to section 5.3 to configure them via the web server.

For other settings it will be necessary to get connected to the web server as detailed in next section.

In case it is necessary to reset the panel to factory default settings:

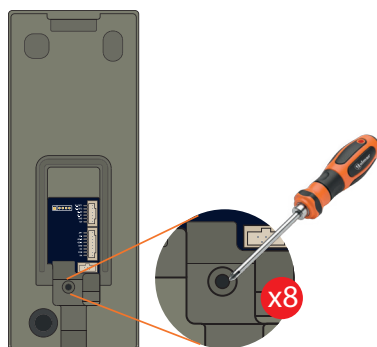

Keep pressed for 8 seconds the tact button, leds will blink 3 times. The module will boot and the address will be again the factory default 10.0.0.254.

Unless a specific network conflict, always is recommended to chose the automatic assignment, then the system will set each device with its corresponding IP address automatically.

The IP G+ system takes networks in the range 10.xxx.xxx.xxx in automatic IP assignment.

### 5.2 Registration of CLIP panel as an private panel (PCM)

**Importat note:** to configure a PCM mode, you must first have a master panel configured to act as the controller. Any panel from the Golmar range can be used as the master panel, including: **EL632/48V G+, 6502/G+, 6507/G+.**

From the Web Server, we can configure the PCM mode. This option is used to call only the monitors associated with a single apartment address in a system with multiple apartments and different blocks (see sections 5.3 and 5.4). It is also possible to configure this option through SCT 1.27 (see the guide for further details)

DOOR PANEL	
Name	BLOCK 1
PCM	<input checked="" type="checkbox"/>
Block number	1
Door panel number	1
Floor number	0
Push button	1
Monitor address	1001
PCM Number	1

**Note:** If PCM mode is enabled on our panel, the full apartment number must be entered, for example: "1001, 2003, 4006", etc. The maximum number of PCM entries allowed is 7.

### 5.3 Panel registration by Web Server

The Clip/G+ can only be set as a block panel (block 1 - 98), not being possible to set as general panel (block 99). When the number of block and panel needs to be different than 1 or it is required to adjust any other setting, it will be mandatory to use the web server.

The factory IP address of the panel is 10.0.0.254. Check that your computer network connection is in the same range. To change your computer network parameters perform the following step.

Go To network settings in control panel.

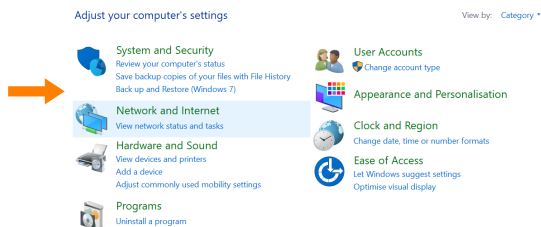

Change the active Ethernet network.

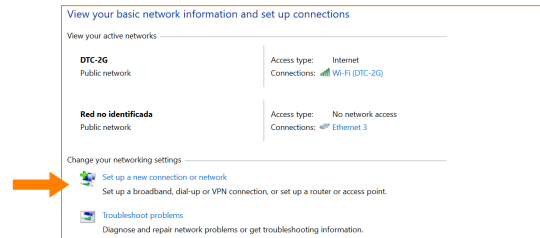

Enter into "properties".

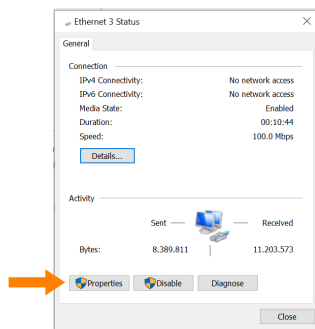

Select Internet protocol IPv4.

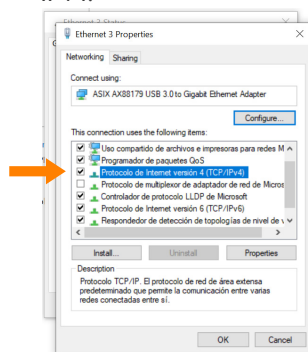

Enter into "properties".

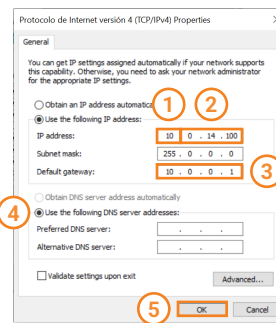

- ① IP address should start by 10
- ② Next three numbers should have a value lower than 255
- ③ Assign 10.0.0.1 as Gateway
- ④ Do not assign DNS
- ⑤ Confirm settings

Now the computer is configured to work in the same IP range as the panel.

Type the IP in the browser: Factory IP is 10.0.0.254.

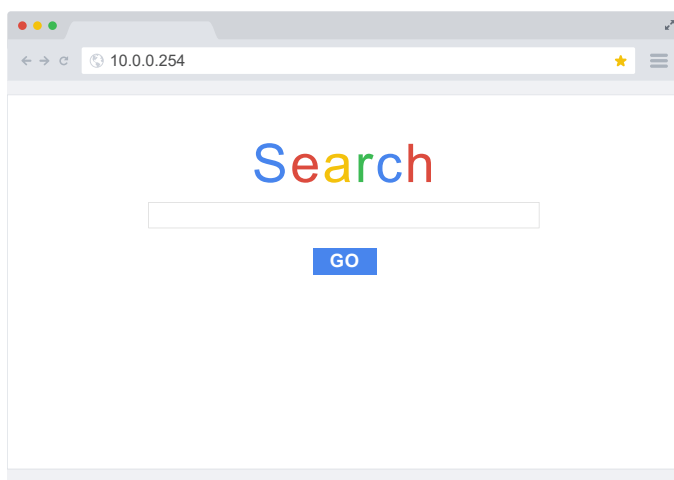

Log into the webserver.



The default password is 2718.

### 5.4 Settings

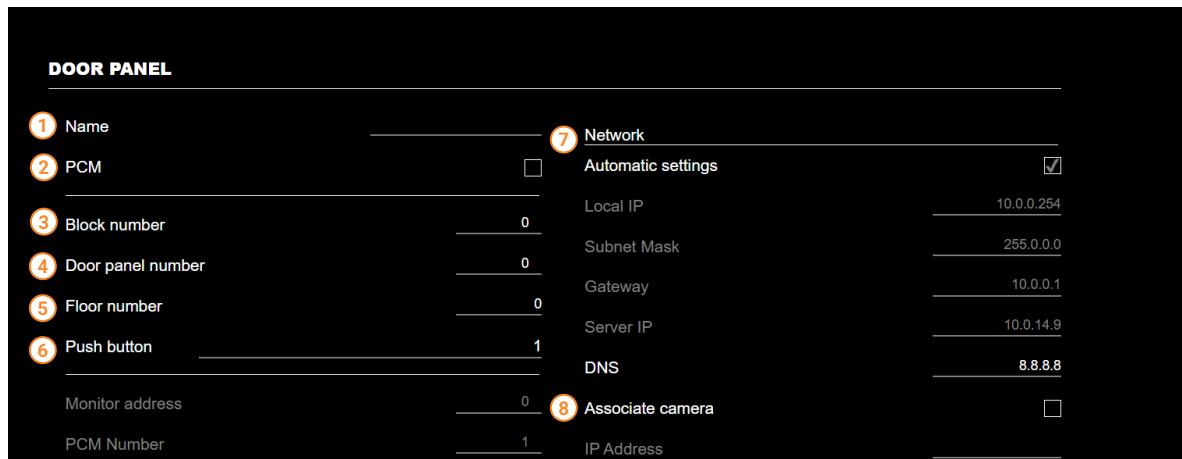

- [Settings](#)
- [Access cards](#)
- [SIP servers](#)
- [Devices](#)
- [Event Log](#)

- ① Name of panel
- ② Registration as a private call panel PCM
- ③ Block number 1 to 98
- ④ Door panel number 1 to 99
- ⑤ Floor number 1 to 799
- ⑥ Push button for call to monitor
- ⑦ Automatic assignment of network parameters
- ⑧ CCTV integration



- [Settings](#)
- [Access cards](#)
- [SIP servers](#)
- [Devices](#)
- [Event Log](#)
- [About](#)

- ① Panel language
- ② Available access cards (only with monitor Edge)
- ③ Tamper alarm
- ④ Sound acoustic messages
- ⑤ Message volume level 1 to 5
- ⑥ Communication volume level 1 to 10
- ⑦ RTSP protocol for integrate with NVR
- ⑧ Lock activation times

**Note:** If you want to add your Clip panel to an NVR, please note that it will occupy one channel and the RTSP protocol must be enabled.

The required RTSP URL is:

rtsp://ip:port/ch

rtsp://10.0.14.9:554/ch01

## 5.5 Access cards

Address	Name	CardID
1001	001	0424F4
1002	002	F78C25

Settings

**Access cards**

SIP servers

Devices

Event Log

About



In this section, you can find all cards that have been registered through the Clip G+ panel (tag and card registration is only possible using an Edge 7, Edge 7W, Edge 7/IO or Edge 7AW monitor). The registration process is carried out by the installer from the monitor's installer menu (for more details, please refer to the Edge 7 monitor manual).

- ① Export: export a CSV file with the apartment address and name.
- ② User List: export a CSV file with the panel position, address, name, and ID of the tags or cards.
- ③ Import: import a CSV file containing previously registered tags or cards.

## 5.6 SIP servers

Settings

Access cards

**SIP servers**

Devices

Event Log

About



In the SIP Server section, we will be able to add the device in the SIP server or PABX switchboard registered in the master panel previously. If the registration is successful, the panel will be able to make calls from SIP devices included in the system using the extensions assigned to the monitor in the SIP server.

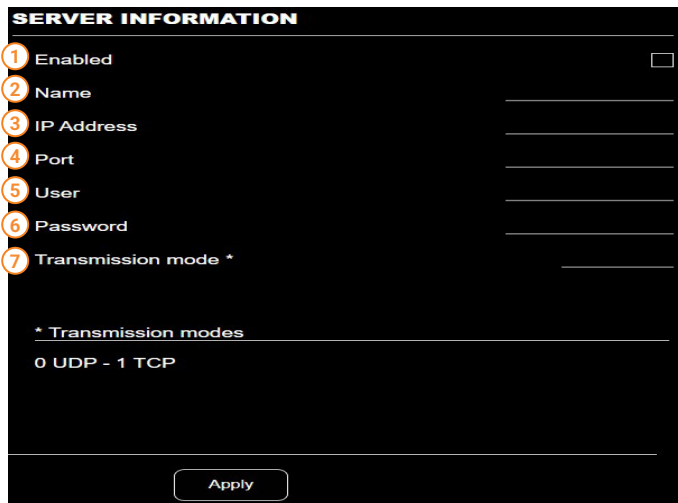

- ① Enable/Disable the SIP Server
- ② Name of the SIP Server
- ③ IP Address of the SIP Server
- ④ Communication port 5060 by default
- ⑤ Created extension for the door panel
- ⑥ Password of the created extension
- ⑦ Transmission mode (0-UDP - 1-TCP)

User and password created in the PABX switchboard

**Note:** Golmar does not guarantee the full compatibility with all SIP server platforms. If your server is not compatible, for further support, please contact Golmar technical service.

### 5.7 Devices

In the "Devices" section, it is possible to check which devices, such as monitors, panels or CCTV cameras are registered in the system and edit them.

**Note:** devices section is only visible in the master panel, since this is the one which manages the system devices registrations.

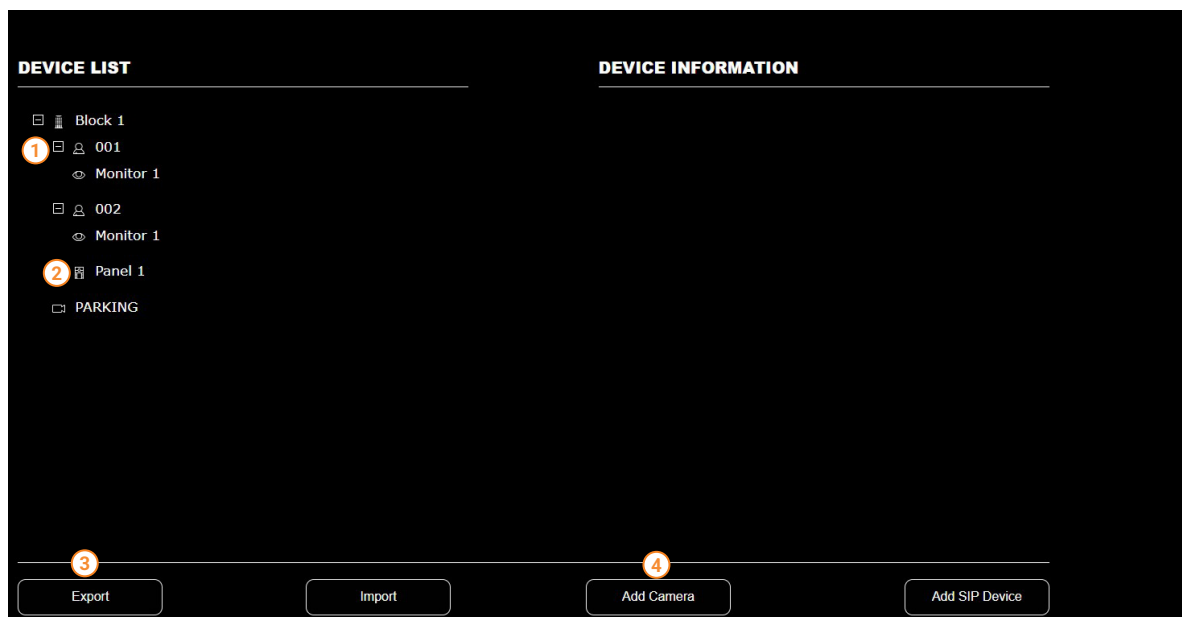

① Monitor edition:

It is possible to modify the name of the monitors appearing on the panels namelist, check which IP address has been assigned, and set a floor number to which the monitor belongs, if there is any lift control unit in the system.

② Door panel edition:

It is possible to modify the names of the panel which appears in the devices list, check which IP address they have, and set a floor number, if there is any lift control unit in the system. It is also possible to manage the visibility, to set which apartments can preview the door panel images and which cannot.

③ Export devices list:

It is very important to make a backup of the panels device list configuration. In case the master panel is to be serviced, we can easily upload the devices configuration into the new panel using this file.

#### ④ CCTV camera:

It is possible to add CCTV cameras, which are connected into the network. The cameras need to be ONVIF compatible and they need to be in the same IP network range. Golmar only guarantees full compatibility with Golmar Cameras.

**ADD CAMERA**

---

**Name**

**IP Address**

**User**

**Password**

Cancel
Add

- Name: set as name for the camera.

- IP Address: IP address of the IP CCTV camera.

- User: user of the CCTV camera webserver.

- Password: password to acces the camera webserver.

The CCTV camera needs to set the video parameters:

Stream channel: Substream

Resolution: 640x480 max

FPS: 25

Compression: H.264

Codificaction: Baseline

Biterate: CBR, 512

Frame interval: 20ms

## 5.8 Event log

Event type	Address / Code	Time	Date
call end	1001	2026-06-11	14:56:43
Lock 1 activation	1001	2026-06-11	14:56:35
Call Communication established	1001	2026-06-11	14:56:33
Call to	1001	2026-06-11	14:56:26
call end	1001	2026-06-11	14:56:14
Call Communication established	1001	2026-06-11	14:56:13
Call to	1001	2026-06-11	14:56:04
Access RFID	F78C25	2026-06-11	08:57:09
call end	1001	2026-06-11	06:06:32
Call Communication established	1001	2026-06-11	06:06:31
Call to	1001	2026-06-11	06:06:29

Export

[Settings](#)

[Access cards](#)

[SIP servers](#)

[Devices](#)

**[Event Log](#)**

[About](#)



In the "Event log" section it is possible to check the events in the installation, and which devices involve. It is possible to see the time and date when the event ocured and export the event log list into an txt file.

### 5.9 About

In the "About" section, it is possible to check the local information of the device as the physical address, and the network parameters. It is also possible to check the firmware and hardware version and modify the password to access to the settings.

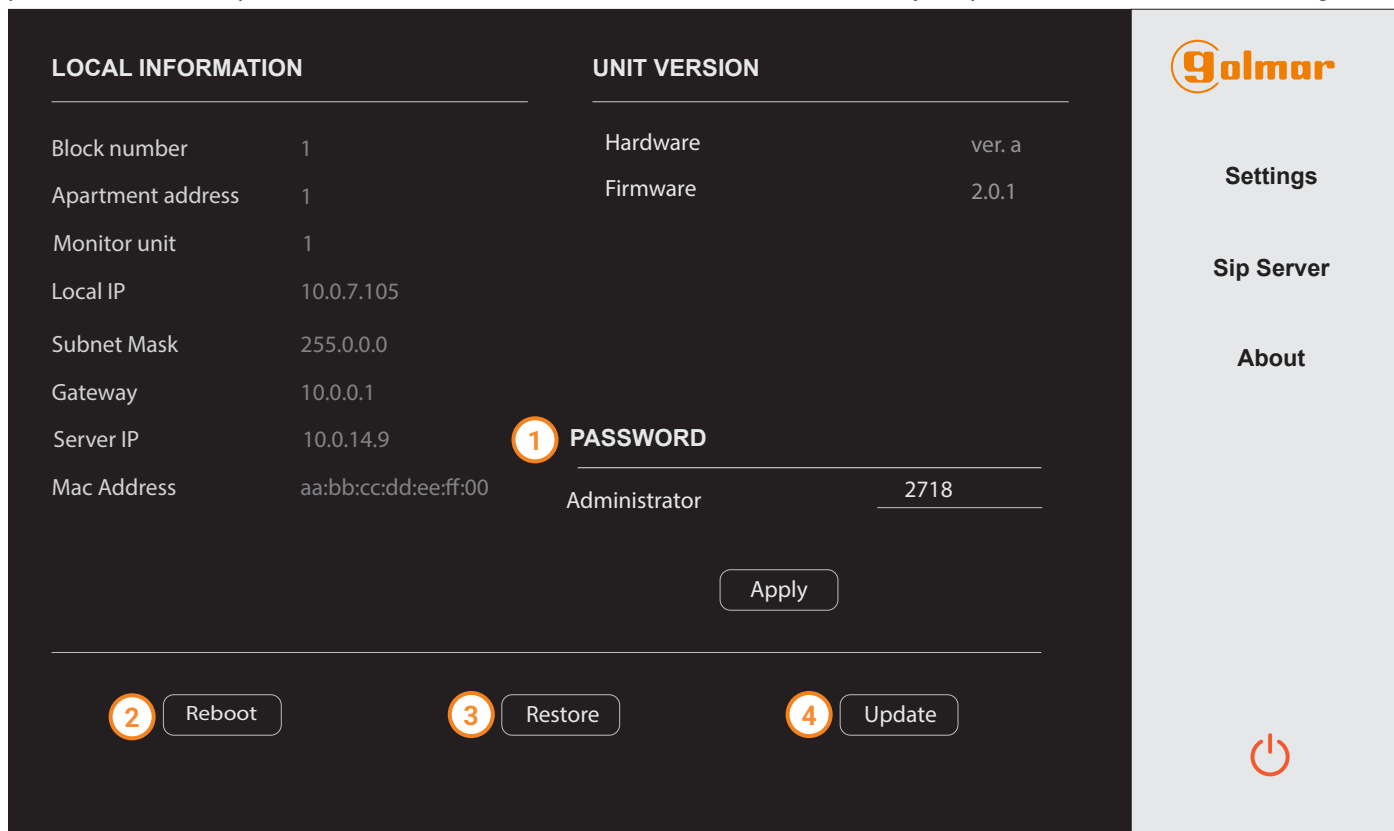

① Modify password

② Reboot

③ Restore

④ Update FW version

## 6. CLIP LED STATUS

SmartPrompt function

Different illumination according to system and call status.

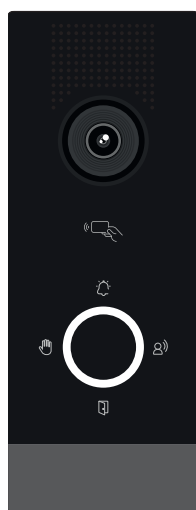

Normal status

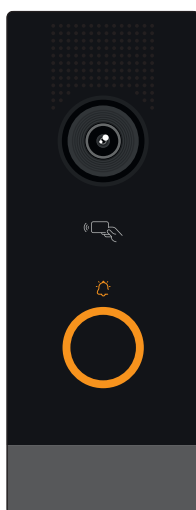

Call in progress

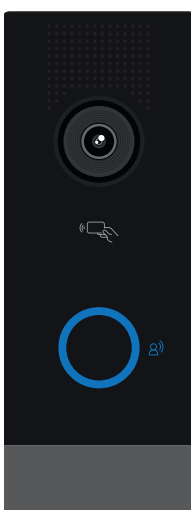

Communication

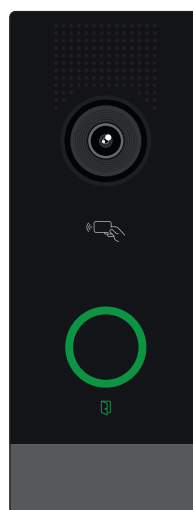

Door is open

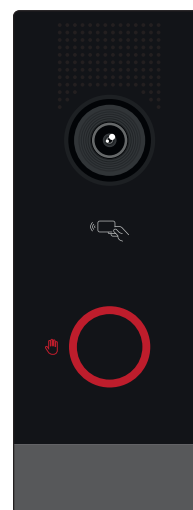

Access denied or call target cannot be reached

## 7. SETTINGS FOR CALLS

Once our Clip panel has been configured with an Edge 7 monitor, calls will be established by default using call code " 1 " to reach the first monitor in the building block to which the apartment belongs.

If you wish to call another apartment within the same building block, you must specify the apartment number associated with that monitor. It is also possible to place the call using the full 4 digit code.

**Note:** this settings only is available by Web Server.

DOOR PANEL	
Name	Block 1
PCM	<input type="checkbox"/>
Block number	1
Door panel number	1
Floor number	1
Push button	1

Default apartment number (single digit)

DOOR PANEL	
Name	Block 1
PCM	<input type="checkbox"/>
Block number	1
Door panel number	1
Floor number	0
Push button	1001

Apartment number (4 digits)

### 7.1 Grouped calls, separated by ( , )

If your installation includes multiple monitors and you want them to ring simultaneously, you can configure them as "slaves" of the main monitor.

However if you have a second monitor assigned to a different apartment address, you can still call both monitors by entering their apartment numbers separated by a comma (,) in the Push Button option, provided they belong to the same building block. Up to 6 monitors can be called simultaneously.

Push button	1,3,5,7
-------------	---------

Push button	1001,1003,1005,1007
-------------	---------------------

### 7.2 Calls for block concierge & general concierge

To make calls to the concierge block, the first number must be the number corresponding to the block, followed by the concierge number starting from **851**.

For example, if we belong to block **1** and have one concierge block, the dialing number will be **1851**.

If there is a general concierge, the first two digits are **99**, followed by the concierge number. For example, general concierge number **99**, and since it is the first concierge, the numbering starts at **901**. Followed, the dialing number would be **99901**.

Push button	1851
-------------	------

Push button	99901
-------------	-------



**we take care of your** home

**Golmar Sistemas de Comunicación S.A.**  
C/ Silici 13. Polígono Industrial Famadas  
08940 - Cornellà de Llobregat - Spain  
golmar@golmar.es - (+34) 93 480 06 96

[www.golmar.es](http://www.golmar.es)



Golmar se reserva el derecho a cualquier modificación sin previo aviso.  
Golmar reserves the right to make any modifications without prior notice.  
Golmar se réserve le droit de toute modification sans préavis.