

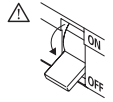

DYNA MINI Sq



EN WARNING: THE LUMINAIRE MUST BE ASSEMBLED WITH A DRIVER SUITABLE FOR ITS TECHNICAL SPECIFICATIONS.
FR AVERTISSEMENT: L'APPAREIL DOIT ÊTRE INSTALLÉ AVEC LE DRIVER INSTALLÉ AVEC UN DRIVER QUI CORRESPOND À SES CARACTÉRISTIQUES TECHNIQUES.
DE WARNUNG: DIE LEUCHTE MUSS MIT EINEM FÜR IHRE TECHNISCHEN SPEZIFIKATIONEN GEEIGNETEN TREIBER BESTÜCKT WERDEN.
PT ATENÇÃO: A LUMINÁRIA DEVE SER MONTADA COM O DRIVER ADEQUADO AS SUAS CARACTERÍSTICAS TÉCNICAS.
ES ATENCIÓN: LA LUMINARIA DEBERÁ MONTARSE CON EL DRIVER ADECUADO A SUS CARACTERÍSTICAS TÉCNICAS.

(mm)	 (mm)	$\frac{W}{mA}$ (mm)	W	mA	V
175x175x127	165x160	1-25	8	250	33
175x175x127	165x160	1-25	17	500	33
175x175x127	165x160	1-25	24	700	34

TOOLS | OUTILS | WERKZEUG | FERRAMENTAS | HERRAMIENTAS

Phillips screwdriver



EN USE GLOVES.
FR UTILISEZ DES GANTS.
DE HANDSCHUHE BENUTZEN.
PT UTILIZE LUVAS.
ES USE GUANTES.

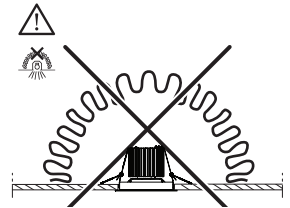
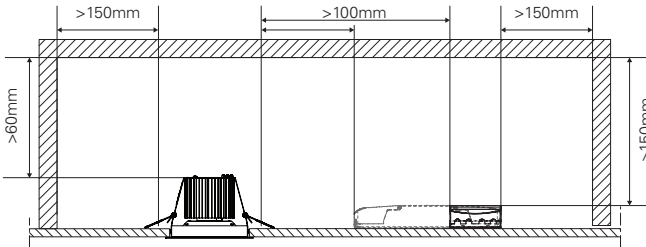

DYNA MINI Sq

90760...

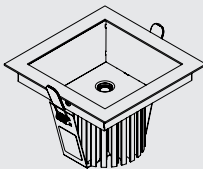

(x1)

CONTROL GEAR ALIMENTATION ÉLECTRIQUE GETRIEBSGERÄT FONTE DE ALIMENTAÇÃO FUENTE DE ALIMENTACIÓN

+ 
IIV864

90000... | 90010... | 90011... | 90030...

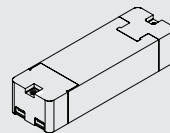



(x1)

**SAFETY CABLE
FILIN D'ACIER
SICHERHEITSKABEL OPTION
CABO DE SEGURANÇA
CABLE DE SEGURIDAD**

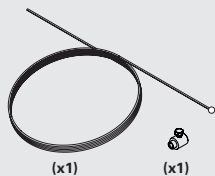
955000



 (mm)
175x175x127

 LxW (mm)
165x160

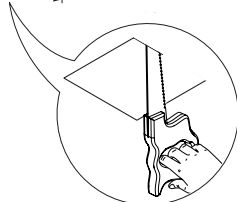
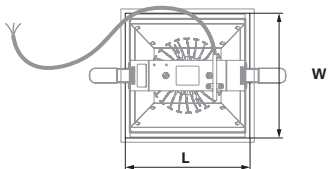

1

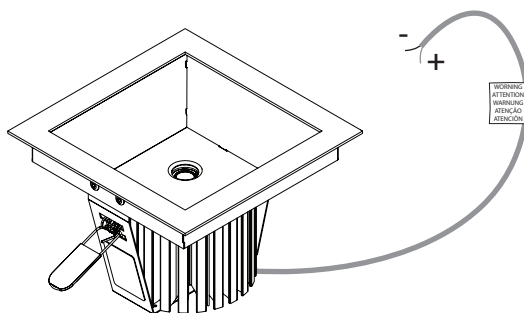

FOR ELECTRICAL CONNECTION, REQUIRES EXTERNAL CONTROL GEAR, READ: POUR LE RACCORDEMENT ÉLECTRIQUE, NÉCESSITE UN ÉQUIPEMENT DE COMMANDE EXTERNE, LIRE : FÜR DEN ELEKTRISCHEN ANSCHLUSS IST EIN EXTERNES STEUERGERÄT ERFORDERLICH, LESEN SIE: PARA LIGAÇÃO ELÉTRICA, REQUER FONTE DE ALIMENTAÇÃO EXTERNA, LER: PARA LA CONEXIÓN ELÉCTRICA, REQUIERE FUENTE DE ALIMENTACIÓN EXTERNA, LEA:



IIV864

2 - SAFETY CABLE OPTION
OPTION FILIN D'ACIER
SICHERHEITSKABEL OPTION
OPÇÃO CABO DE SEGURANÇA
OPCIÓN CABLE DE SEGURIDAD

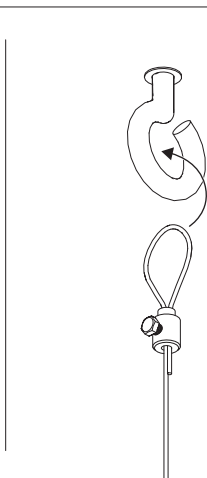
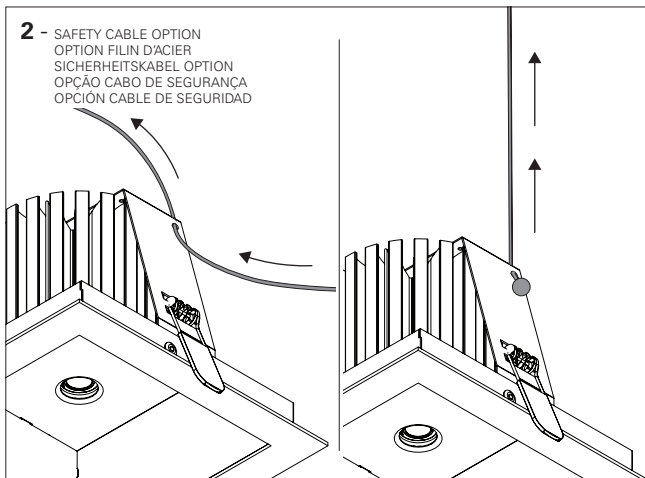

3

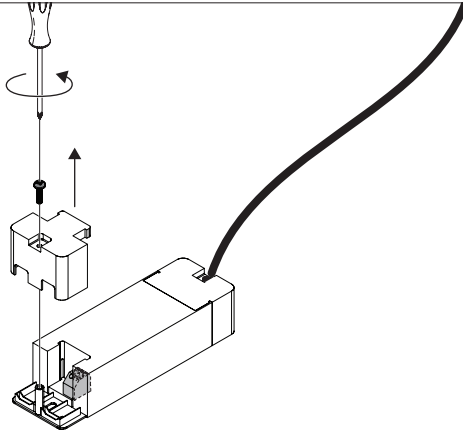

4

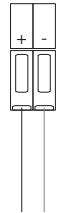
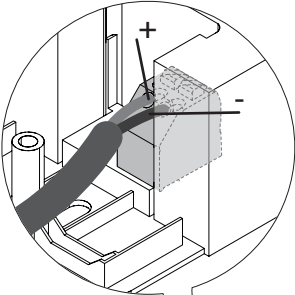

RED	BLACK
ROUGE	NOIR
ROT	SCHWARZ
VERMELHO	PRETO
ROJO	NEGRO



EN WARNING: NEVER CONNECT DIRECTLY ~230V. DRIVER REQUIRED FOR OPERATION.
FR ATTENTION : NE JAMAIS BRANCHER DIRECTEMENT SUR ~230V. NÉCESSITE L'APPLICATION D'UN DRIVER.
DE ACHTUNG: NIEMALS DIREKT AN ~230V ANSCHLIESSEN. FÜR DEN BETRIEB IST EIN TREIBER ERFORDERLICH.
PT ATENÇÃO: NUNCA LIGAR ~230V DIRETO. REQUER APLICAÇÃO DO DRIVER.
ES ATENCIÓN: NO CONECTAR DIRECTAMENTE A ~230V. REQUIERE LA APLICACIÓN DE UN DRIVER.

