

Ceiling rose T24/T26 | Patère de suspension T24/T26| Deckendose T24/T26 | Caixa de alimentação T24/T26 | Base de techo T24/T26

EN INSTALLATION INSTRUCTIONS

FR NOTICE DE MONTAGE

DE MONTAGE-ANLEITUNG

PT INSTRUÇÕES DE MONTAGEM

ES INSTRUCCIONES DE MONTAJE

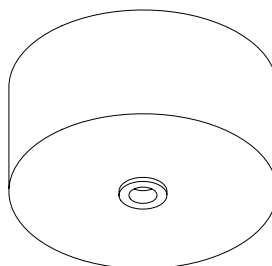

T24

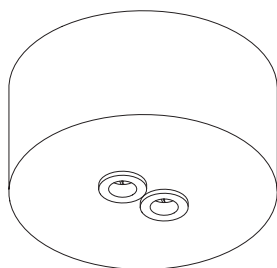

T26

Order code / Code com. / Bestell-Nr. / Código / Código: 978600... | 978601...

EN Please read carefully the installation instructions given before installing the appliance, the general terms and conditions of use and environmental concern with recycling attached. | **FR** Lire attentivement les notices de montage avant l'installation de l'appareil, les conditions générales de ventes et les précautions écologiques liées au recyclage ci-jointes. | **DE** Bitte lesen Sie sorgfältig die Montage-Anweisungen, die Sie vorder Montage des Geräts erhalten haben, Allgemeinen Geschäftsbedingungen und Umweltbewusstsein über Recycling angeschlossen. | **PT** Leia atentamente as instruções de montagem fornecidas antes de instalar o aparelho, as condições gerais de uso e preocupação ambiental com a reciclagem, em anexo. | **ES** Lea atentamente las instrucciones de montaje proporcionadas antes de instalar el aparato, las condiciones generales de uso y la preocupación medioambiental con el reciclaje, que se adjuntan.

EN We reserve the right to make changes on technical specifications, design and installation leaflet without prior notice. | **FR** Sous réserve de modifications au niveau de la conception, des spécifications techniques et de la notice. | **DE** Änderungen von Entwurf, technischen Daten und Bedienungsanleitungen bleiben vorbehalten. | **PT** O fabricante reserva-se no direito de realizar modificações no desenho, especificações técnicas e folheto, sem aviso prévio. | **ES** La empresa se reserva el derecho de hacer modificaciones en los diseños, en las especificaciones técnicas y en los folletos de los productos sin aviso previo.

EN CEILING ROSE
FR PATÈRE DE SUSPENSION
DE DECKENDOSE
PT CAIXA DE ALIMENTAÇÃO
ES BASE DE TECHO

Surface mounted | T24 / T26
 Saillie
 Anbau
 Saliente
 Superficie

 (mm)
 Ø95x45

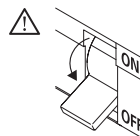

CEILING ROSE
PATÈRE DE SUSPENSION
DECKENDOSE
CAIXA DE ALIMENTAÇÃO
BASE DE TECHO

978600...

SURFACE MOUNTED CEILING ROSE T24 D95
 PATÈRE DE SUSPENSION SAILLIET24 D95
 DECKENDOSE ZUM ANBAUT24 D95
 CAIXA DE ALIMENTAÇÃO SALIENTE T24 D95
 BASE DE TECHO DE SUPERFICIE T24 D95

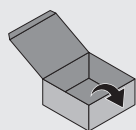

(x2/x4/x6)



(x1)

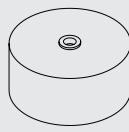

(x1)

978601...

SURFACE MOUNTED CEILING ROSE T26 D95
 PATÈRE DE SUSPENSION SAILLIET26 D95
 DECKENDOSE ZUM ANBAUT26 D95
 CAIXA DE ALIMENTAÇÃO SALIENTE T26 D95
 BASE DE TECHO DE SUPERFICIE T26 D95

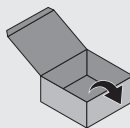

(x8)



(x1)

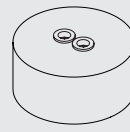



(x1)

EN SURFACE MOUNTED
FR SAILLIE
DE ANBAU
PT SALIENTE
ES SUPERFICIE

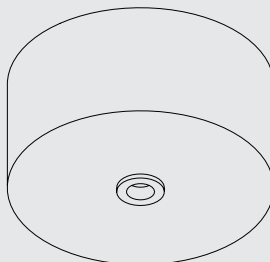
T24



	R		A
T24	35	120	61

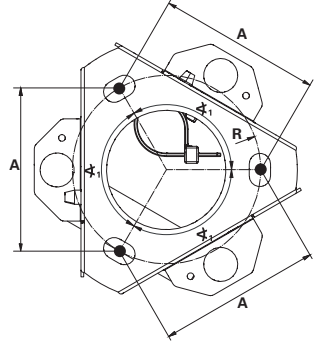
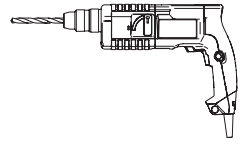

2

1.

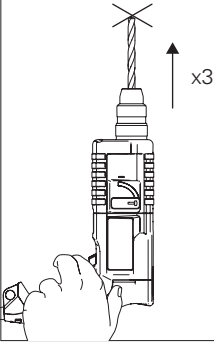

2.

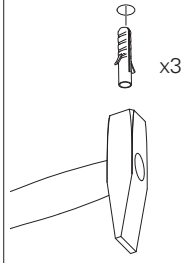

3.

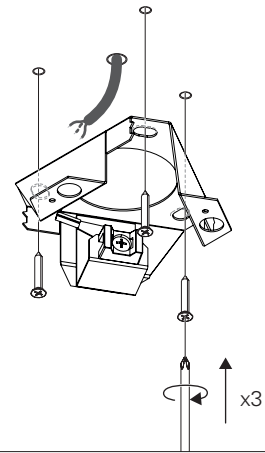

2.1

1.

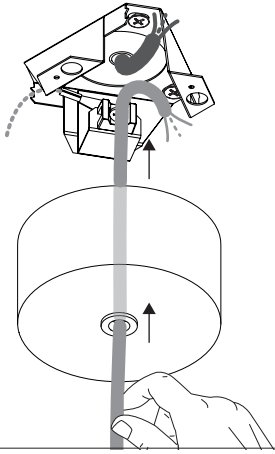

2.

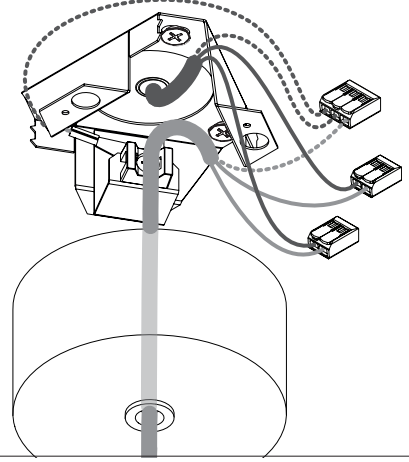

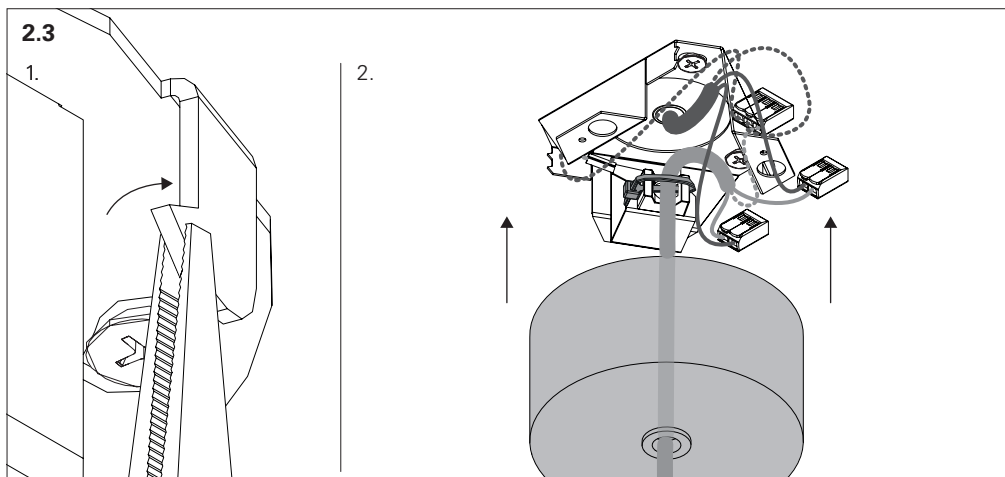
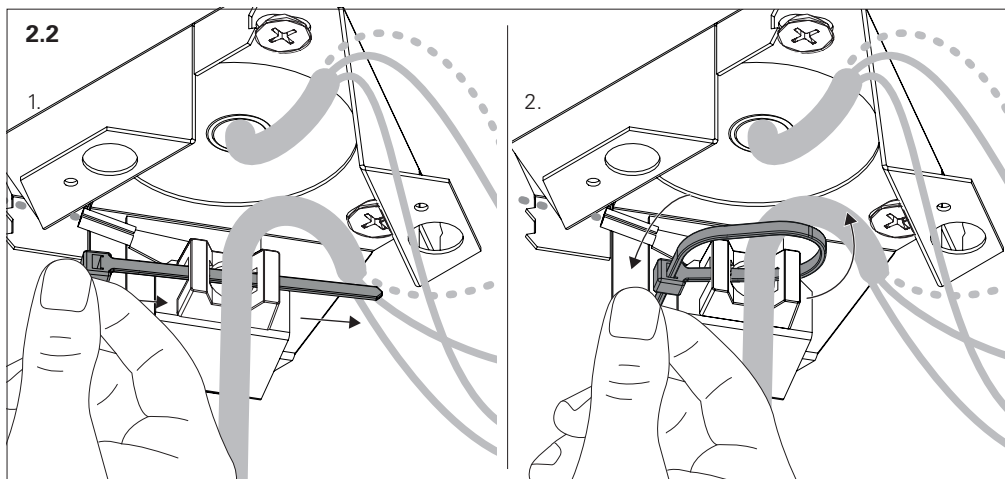

2.4



TO COMPLETE THE INSTALLATION READ THE COMPLEMENTARY MANUALS.
POUR FINIR L'INSTALLATION VOIR LES NOTICES COMPLÉMENTAIRES.
ZUR BEENDIGUNG DER INSTALLATION ZUSÄTZLICHE ANLEITUNG LESEN.
PARA CONCLUIR A MONTAGEM LER MANUAIS COMPLEMENTARES.
PARA FINALIZAR EL MONTAJE LEER LOS MANUALES COMPLEMENTARIOS.

EN SURFACE MOUNTED
FR SAILLIE
DE ANBAU
PT SALIENTE
ES SUPERFICIE

T26

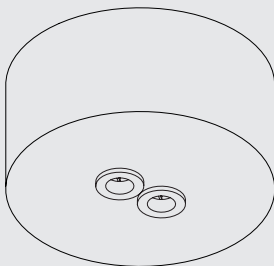

	R	ϕ_1	A
T26	35	120	61

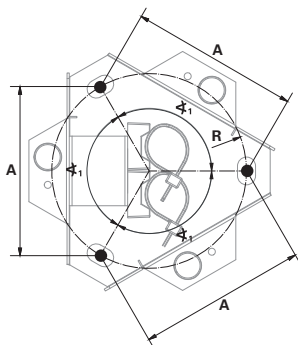
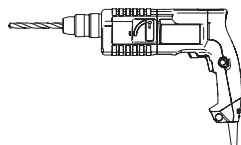

3

1.

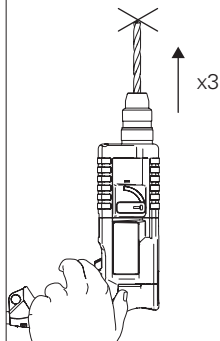

2.

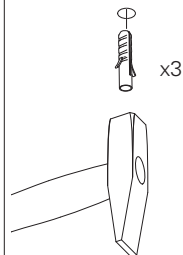

3.

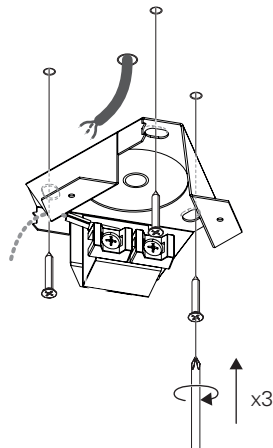

3.1

1.

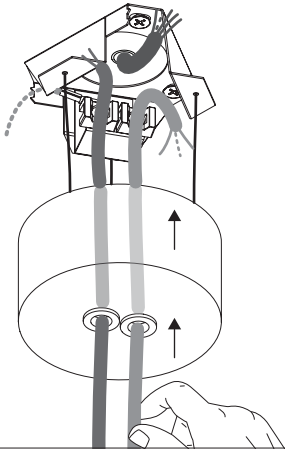

2.

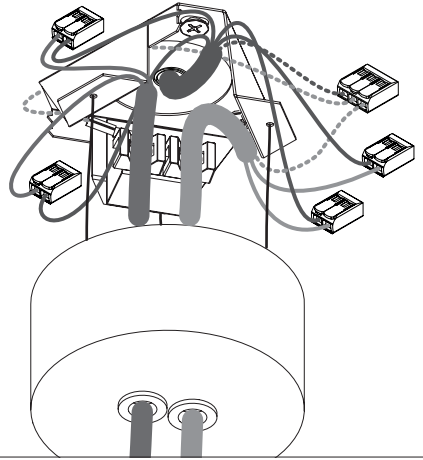

3.2

1.

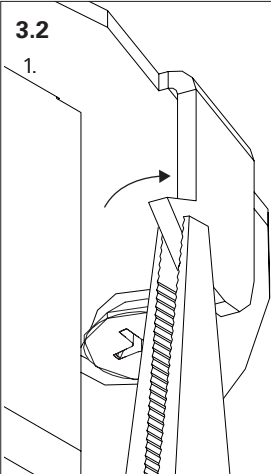

2.

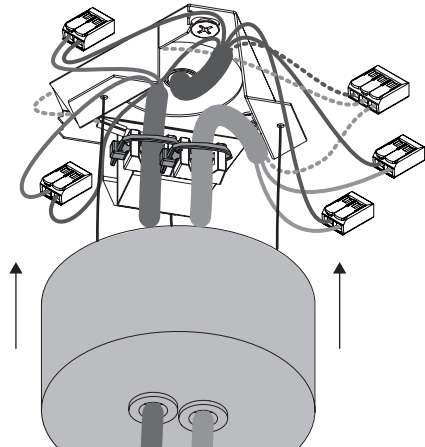

3.3



TO COMPLETE THE INSTALLATION READ THE COMPLEMENTARY MANUALS.
POUR FINIR L'INSTALLATION VOIR LES NOTICES COMPLÉMENTAIRES.
ZUR BEENDIGUNG DER VERSAMMLUNG ZUSÄTZLICHE ANLEITUNG LESEN.
PARA CONCLUIR A MONTAGEM LER MANUAIS COMPLEMENTARES.
PARA FINALIZAR EL MONTAJE LEER LOS MANUALES COMPLEMENTARIOS.